

P-30 PCB

L (mm)

NR. SORGENTI
NR. LIGHT SOURCES

2700K

3000K

4000K

Figura
Image

PROFILO PLAFONE/SOSPENSIONE
CEILING/SUSPENSION PROFILE

PROFILO INCASSO
RECESSED MOUNTED PROFILE

PROFILO PARETE
WALL MOUNTED PROFILE

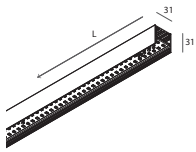

800
1200
2400

1
2
3



NOVALUX srl
442700113

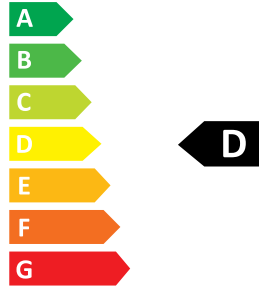

8
kWh/1000h



2019/2015



NOVALUX srl
442700043

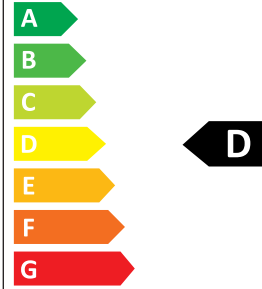

8
kWh/1000h



2019/2015



NOVALUX srl
442700044

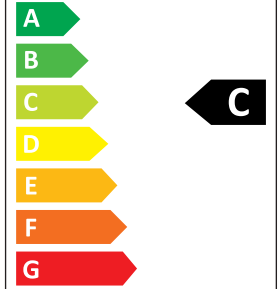

8
kWh/1000h



2019/2015

1

P-30 SPOT LED MIR

L (mm)

NR. SORGENTI
NR. LIGHT SOURCES

2700K

3000K

4000K

Figura
Image

PROFILO PLAFONE/SOSPENSIONE
CEILING/SUSPENSION PROFILE

PROFILO INCASSO
RECESSED MOUNTED PROFILE

PROFILO PARETE
WALL MOUNTED PROFILE
COVER

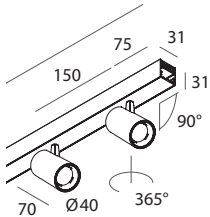

800
800

2
4



NOVALUX srl
442700151

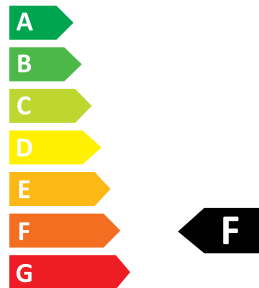

6
kWh/1000h



2019/2015



NOVALUX srl
442700152

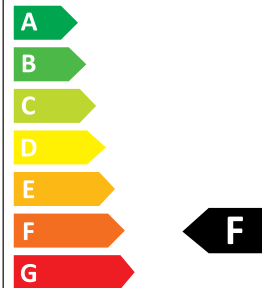

6
kWh/1000h



2019/2015



NOVALUX srl
442700153

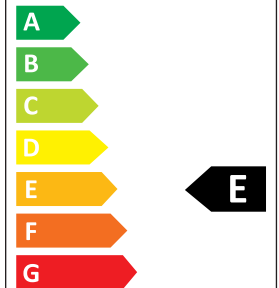

6
kWh/1000h



2019/2015

2

P-30 SPOT LED GALA

L (mm)

NR. SORGENTI
NR. LIGHT SOURCES

2700K

3000K

4000K

Figura
Image

PROFILO PLAFONE/SOSPENSIONE
CEILING/SUSPENSION PROFILE

PROFILO INCASSO
RECESSED MOUNTED PROFILE

PROFILO PARETE
WALL MOUNTED PROFILE
COVER

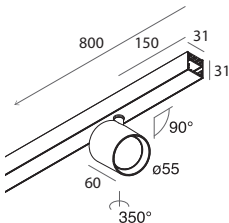

800
800

1
2



Bridgelux
BXRE-27G0800-D-73

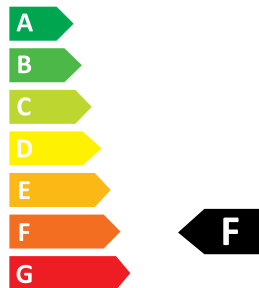

13
kWh/1000h



2019/2015



Bridgelux
BXRE-30G0800-D-73

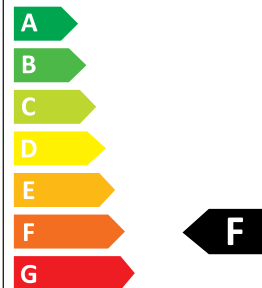

13
kWh/1000h



2019/2015



Bridgelux
BXRE-40G0800-D-73

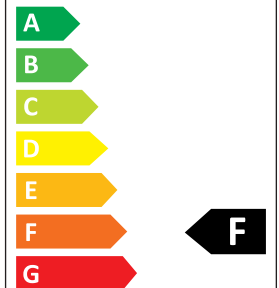

13
kWh/1000h



2019/2015

3

Figura
Image
1



Figura
Image
2



Figura
Image
3

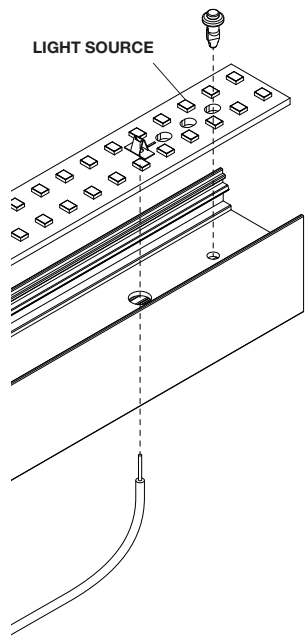
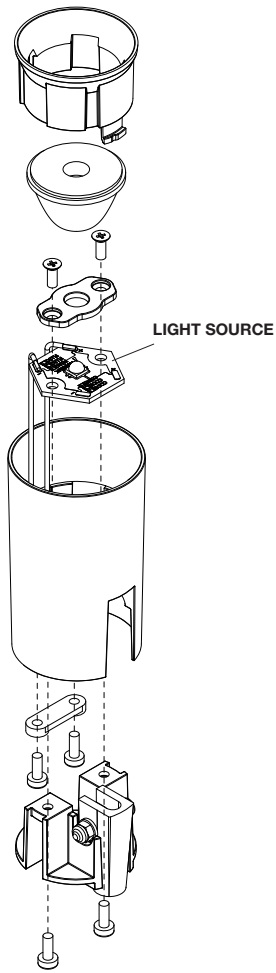