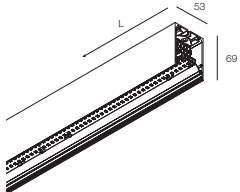
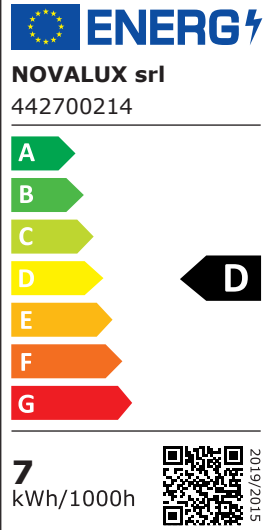
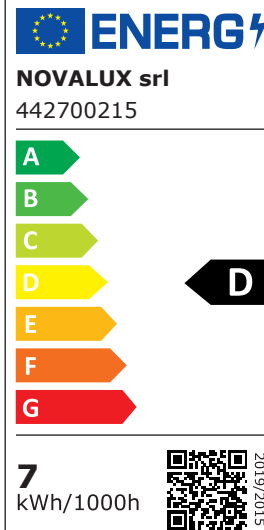
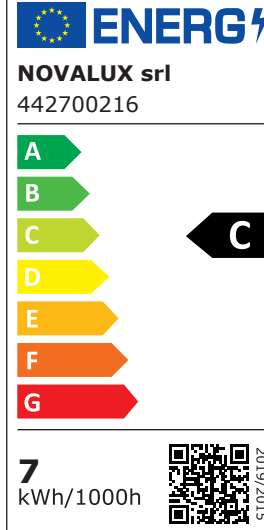
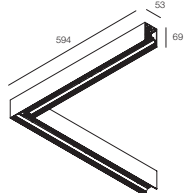

## HERO PLUS

L (mm) NR. SORGENTI NR. LIGHT SOURCES 2700K 3000K 4000K Figura Image

<p>PROFILO LED LINEARE LINEAR LED PROFILE</p> 	<p>1120 1400 1680 1960 2240 2520 2800</p>	<p>4 5 6 7 8 9 10</p>				<p>1</p>
<p>PROFILO LED ANGOLARE 90° 90° CORNER LED PROFILE</p> 	<p>594X594</p>	<p>4</p>				

## HERO PLUS

L (mm) NR. SORGENTI NR. LIGHT SOURCES 2700K 3000K 4000K Figura Image

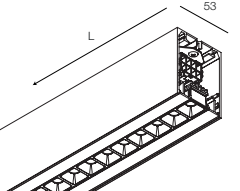
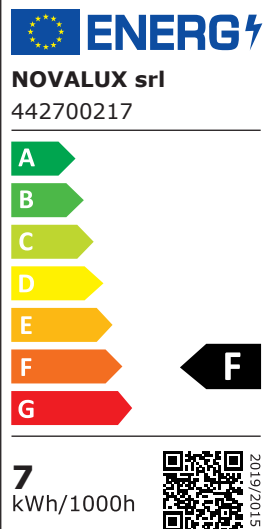
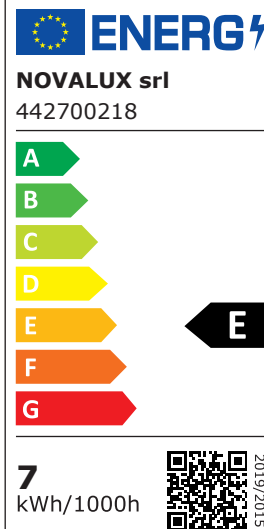
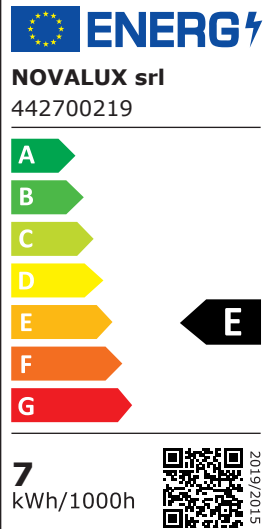
<p>PROFILO LED LINEARE MICRO OTTICHE MICRO-OPTICS LINEAR LED PROFILE</p> 	<p>840 1400</p>	<p>3 5</p>				<p>2</p>

## HERO PLUS

L (mm) NR. SORGENTI NR. LIGHT SOURCES 2700K 3000K 4000K Figura Image

<p>PROFILO LED LINEARE SPOT SPOT LINEAR LED PROFILE</p> 	<p>1120</p>	<p>2</p>				<p>3</p>

Figura  
Image  
1



Figura  
Image  
2

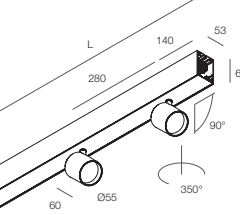
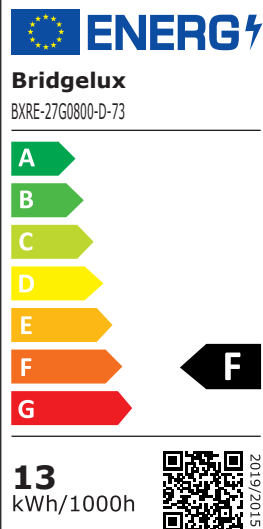
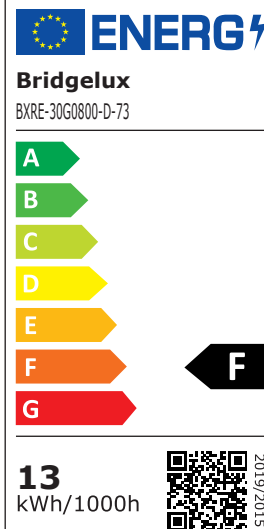
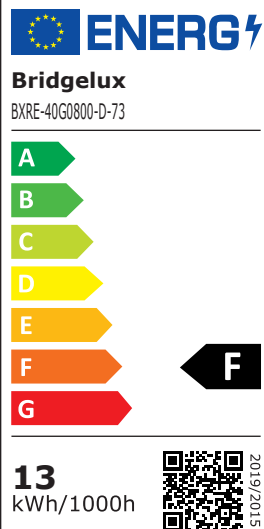

Figura  
Image  
3

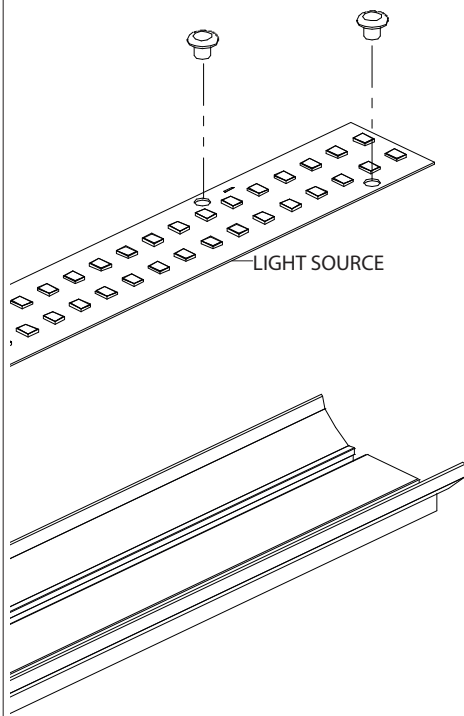
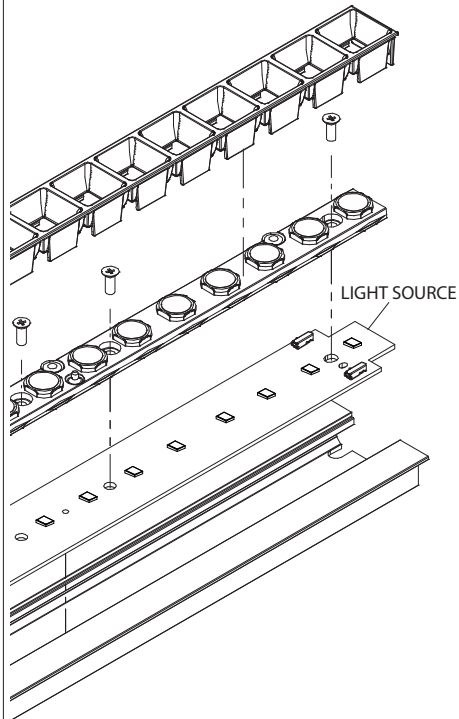