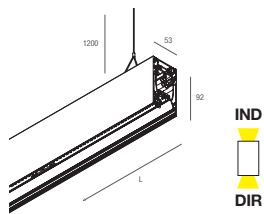
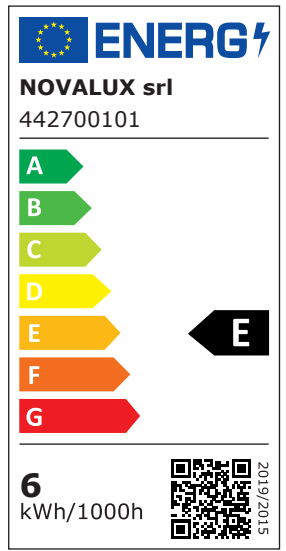
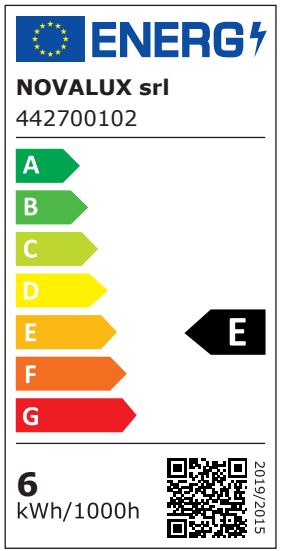
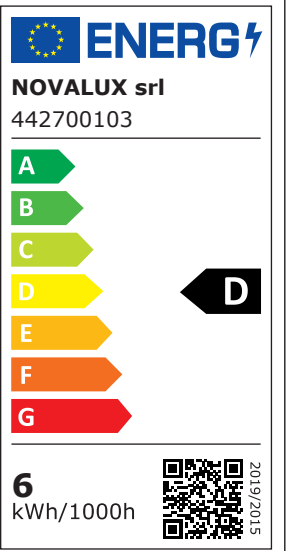
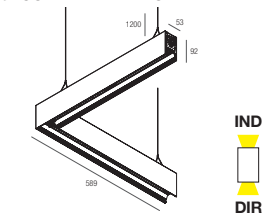
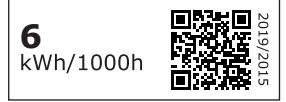
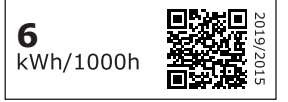
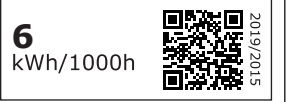

## HERO B

L (mm) NR. SORGENTI NR. LIGHT SOURCES 2700K 3000K 4000K

Figura Image

|  |         |                       |   |  |   |   |
|--|---------|-----------------------|---|--|---|---|
| <b>PROFILO LED LINEARE</b><br><b>LINEAR LED PROFILE</b><br>          | 1120    | <b>3 IND + 4 DIR</b>  |  |  |  | 1 |
|  | 1400    | <b>4 IND + 5 DIR</b>  |   |  |   |   |
|  | 1680    | <b>5 IND + 6 DIR</b>  |   |  |   |   |
|  | 1960    | <b>6 IND + 7 DIR</b>  |   |  |   |   |
|  | 2240    | <b>7 IND + 8 DIR</b>  |   |  |   |   |
|  | 2520    | <b>8 IND + 9 DIR</b>  |   |  |   |   |
|  | 2800    | <b>9 IND + 10 DIR</b> |   |  |   |   |
| <b>PROFILO LED ANGOLARE 90°</b><br><b>90° CORNER LED PROFILE</b><br> | 589x589 | <b>4 IND + 4 DIR</b>  |  |  |  | 1 |

## HERO B

L (mm) NR. SORGENTI NR. LIGHT SOURCES 2700K 3000K 4000K

Figura Image

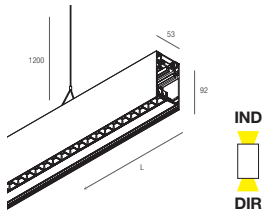
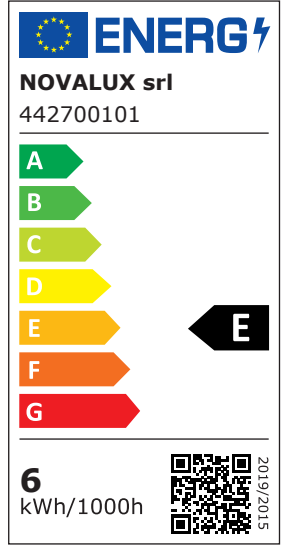
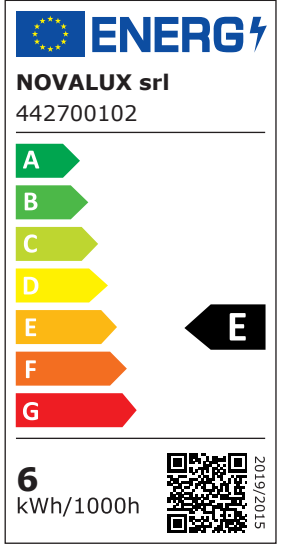
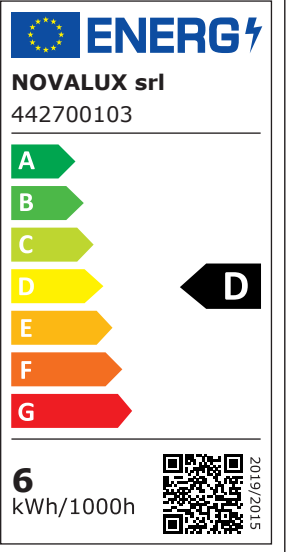
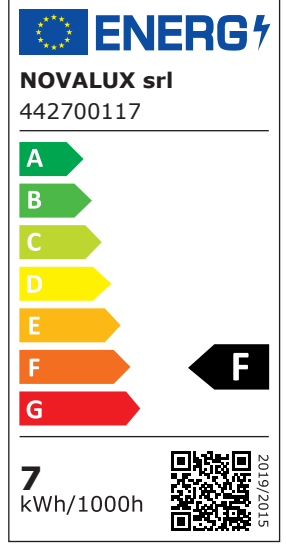
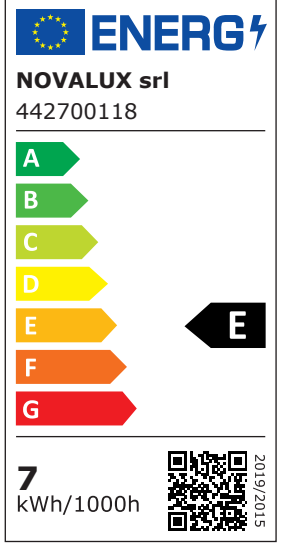
|  |      |   |   |  |   |   |
|--|------|---|---|--|---|---|
| <b>PROFILO LED LINEARE</b><br><b>MICRO OTTICHE</b><br><b>MICRO-OPTICS LINEAR</b><br><b>LED PROFILE</b><br> | 1428 | + |  |  |  | 1 |
|  |      |   | <b>4 IND</b>  |   |   |   |

# HERO B

L (mm)

NR. SORGENTI  
NR. LIGHT SOURCES

2700K

3000K

4000K

Figura  
Image

PROFILO LED LINEARE SPOT  
SPOT LINEAR LED PROFILE

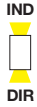
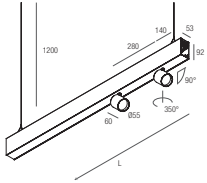

1120

3 IND

+

2 DIR

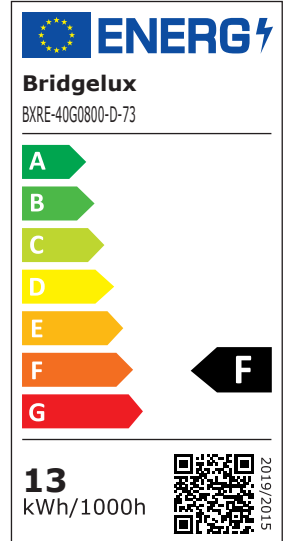
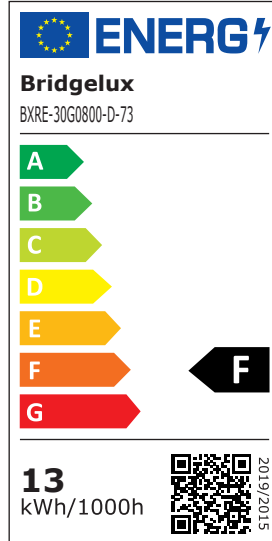
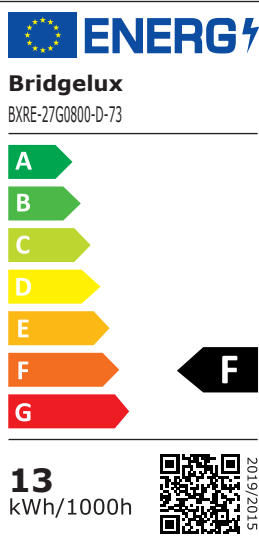
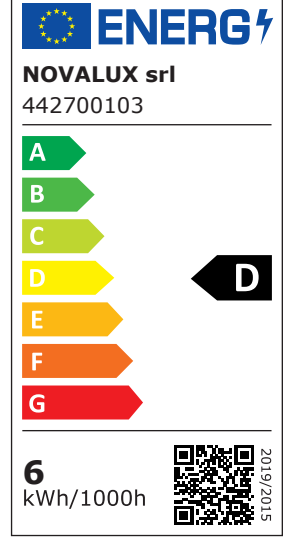
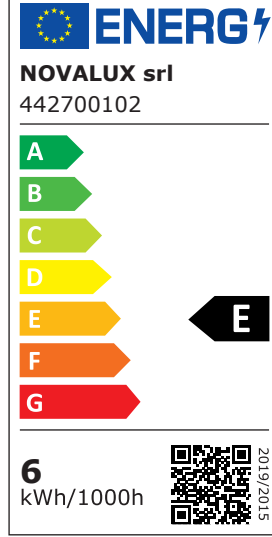
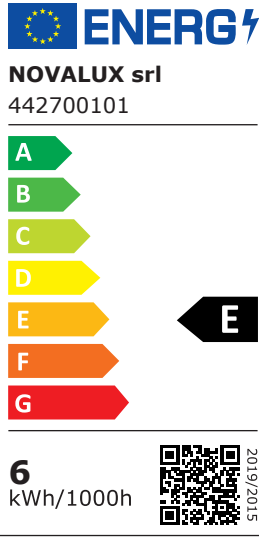

1

3

Figura  
Image

1

LIGHT SOURCE



Figura  
Image

2

LIGHT SOURCE

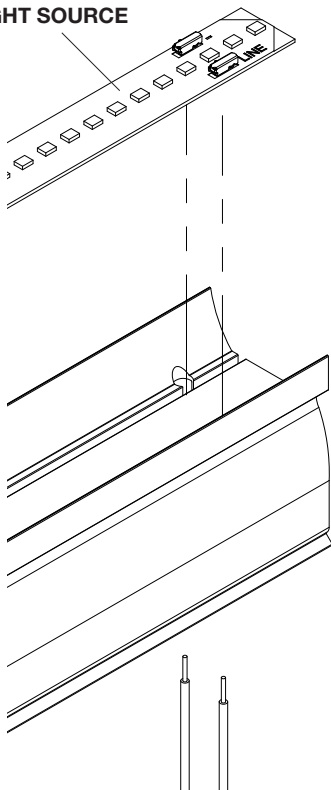

Figura  
Image

3

LIGHT SOURCE

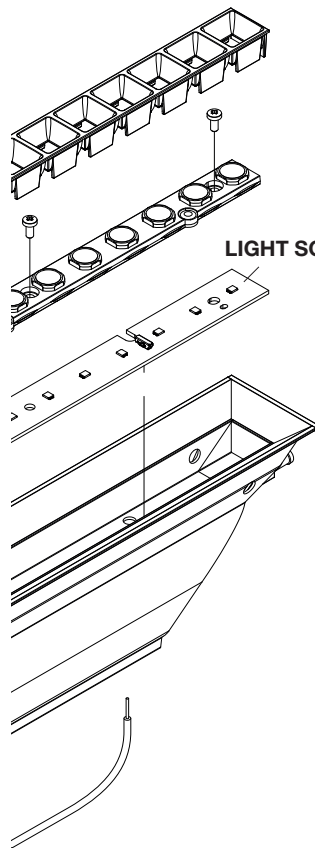