

# YALE

Pannello LED in lamiera di acciaio verniciata a polvere, lenti in policarbonato e riflettori in tecnopolimero. UGR<19.  
 Installabile ad incasso su controsoffitto a pannelli 600x600mm con struttura a vista senza accessori o ad incasso a rasamento con profilo da rasare da ordinare a parte. Installabile a plafone con apposito box. Alimentatore elettronico Incluso.

LED panel made of powder coated steel body, polycarbonate lens and technopolymer reflectors. UGR<19.  
 No accessories needed for exposed grid ceiling, or kit for levelled recessed installation to be ordered separately. Box required for ceiling mounting.  
 Integrated electronic driver.

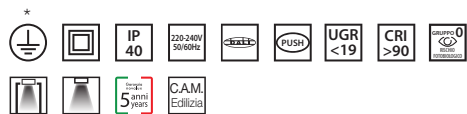

\* Solo versione DALI-PUSH / Only DALI-PUSH version

Per sopperire alle attuali problematiche di reperibilità dei componenti elettronici, disponiamo di articoli alternativi (non combinabili) di pari caratteristiche tecniche. In order to meet the current problems of availability of electronic components, we have alternative items (not combinable) of the same technical features.

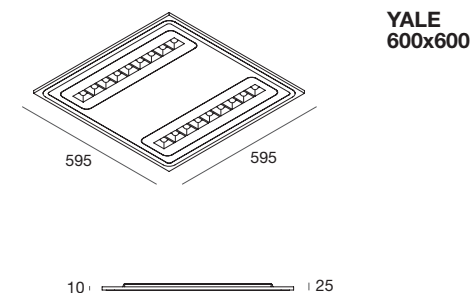

**YALE  
600x600**

POWER	FLUX	4000K <input type="checkbox"/>
30W	4082 lm	<b>109501.01</b>

**DALI-PUSH**

POWER	FLUX	4000K <input type="checkbox"/>
30W	4082 lm	<b>109505.01</b> <b>109503.01</b>

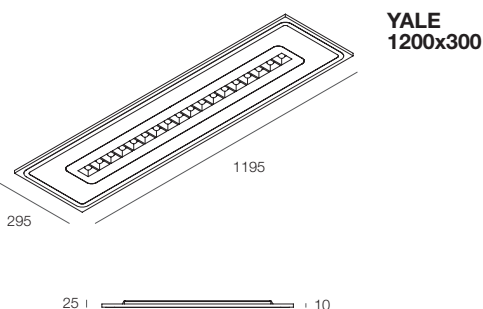

**YALE  
1200x300**

POWER	FLUX	4000K <input type="checkbox"/>
30W	4509 lm	<b>109502.01</b>

**DALI-PUSH**

POWER	FLUX	4000K <input type="checkbox"/>
30W	4509 lm	<b>109506.01</b> <b>109504.01</b>

YALE

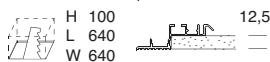
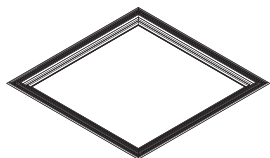
ACCESSORI  
ACCESSORIES

KIT PER INSTALLAZIONE AD  
INCASSO A RASAMENTO  
Profilo da rasare su cartongesso  
di spessore 12,5 mm.  
Il pannello si installa in appoggio.

KIT FOR LEVELLED RECESSED  
INSTALLATION  
Profile to be levelled on 12,5 mm  
thick plasterboard.

CODE VERSION (mm)

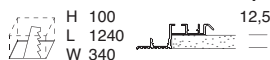
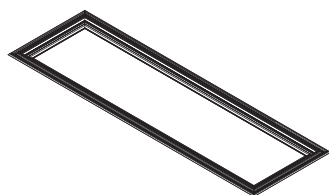
**102028.99** 600x600**102029.99** 1200x300

KIT ANTICADUTA

ANTI FALL-OUT KIT

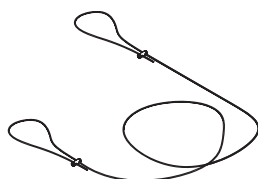

CODE L (mm)

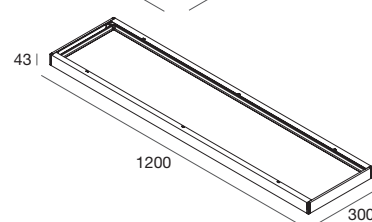
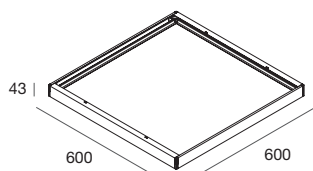
**104119.99** 3000BOX PER INSTALLAZIONE  
A PLAFONE

In estruso di alluminio.  
Kit da assemblare, non installabile  
a parete.  
Idoneo per alloggiamento del kit di  
emergenza (1020A4.99/1020A5.99).

BOX FOR CEILING MOUNTING  
In extruded aluminium.  
To be assembled, not suitable for  
wall surface mounting.  
Suitable for emergency kit  
(1020A4.99/1020A5.99).

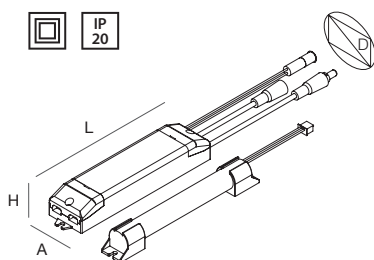
CODE  VERSION (mm)**102086.01** 600x600**102087.01** 1200x300KIT ALIMENTAZIONE  
IN EMERGENZA

Per versioni 600x600 e 1200x300.  
Completo di connettori  
polarizzati per il collegamento  
dell'alimentatore.

KIT FOR EMERGENCY  
For 600x600  
and 1200x300 versions.  
Polarized connectors included.

CODE TIME CHARGE A (mm) D (mm) H (mm) L (mm)

**1020A4.99** 1h 12h 38 44 25 164**1020A5.99** 3h 12h 38 44 25 164

Flusso in emergenza - Emergency flux 1h 3h

**YALE 600x600 30W 14% 5%****YALE 1200X300 30W 14% 6%**