

THE PANEL 2

ACCESSORI PER INSTALLAZIONE AD INCASSO ACCESSORIES FOR RECESSED MOUNTED

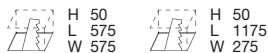
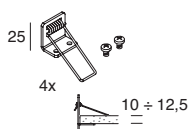

KIT MOLLE PER INSTALLAZIONE AD INCASSO

Per versioni 600x600 e 1200x300, per installazione in battuta in cartongesso di spessore 10-12,5 mm.

SPRINGS KIT FOR RECESSED INSTALLATION

For 600x600 and 1200x300 versions, for installation by frame contrasting in plasterboard of thickness 10-12,5 mm.

CODE

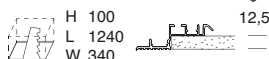
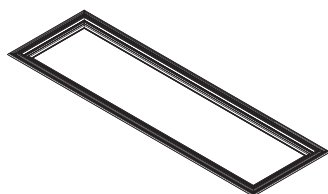
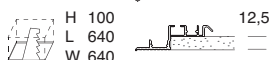
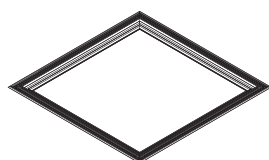
16215.99

KIT PER INSTALLAZIONE AD INCASSO A RASAMENTO

Profilo da rasare su cartongesso di spessore 12,5 mm. Il pannello si installa in appoggio.

KIT FOR LEVELLED RECESSED INSTALLATION

Profile to be levelled on 12,5 mm thick plasterboard.

CODE

VERSION

102028.99

600x600

102029.99

1200x300

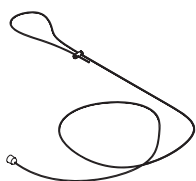

KIT ANTICADUTA

Cavo in acciaio da fissare a soffitto o strutture tramite morsetto in ottone nichelato e aggancio a vite sul pannello.

ANTI FALL-OUT KIT

Steel cable to be fixed to the ceiling or structures using a nickel-plated brass clamp and screwed on the panel.

CODE

L (mm)

102031.99

3000

Per accessori di installazione su controsoffitti a struttura nascosta, contattare l'ufficio tecnico Novalux.
For installation accessories on concealed grid ceilings, please contact Novalux technical office.

THE PANEL 2

ACCESSORI PER INSTALLAZIONE A PLAFONE ACCESSORIES FOR CEILING MOUNTED

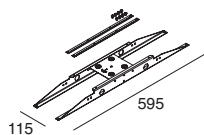

KIT PER INSTALLAZIONE A PLAFONE
Per versioni 600x600 e 1200x300, non installabile a parete o in fila continua.
Distanza tra prodotto e soffitto 40 mm.

CODE

16213.99

KIT FOR CEILING MOUNTING
For 600x600 and 1200x300 versions, not suitable for wall surface or continuous line installation.
Distance between the fixture and the ceiling 40 mm.

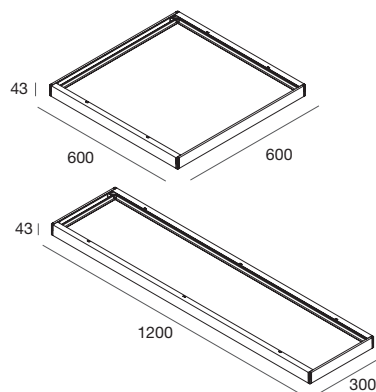

BOX PER INSTALLAZIONE A PLAFONE
Kit da assemblare, non installabile a parete.
Idoneo per l'alloggiamento del kit di emergenza (102025.99/102026.99).

CODE



VERSION

102086.01

600x600

102087.01

1200x300

KIT FOR CEILING MOUNTING
To be assembled, not suitable for wall surface mounting.
Suitable for emergency kit (102025.99/102026.99).

THE PANEL 2

ACCESSORI PER INSTALLAZIONE A SOSPENSIONE ACCESSORIES FOR SUSPENSION MOUNTED

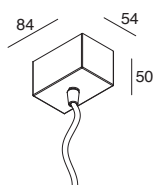

KIT DI ALIMENTAZIONE
PER SOSPENSIONE
Cavo di alimentazione trasparente

POWER SUPPLY KIT
FOR SUSPENSION
Transparent power cable

CODE L (mm) Cavo / Cable (mm²)

| | | |
|------------------|------|-------|
| 108919.01 | 1200 | 3x1,5 |
| 108920.01 | 3000 | 3x1,5 |
| 108921.01 | 1200 | 5x1,5 |
| 108922.01 | 3000 | 5x1,5 |

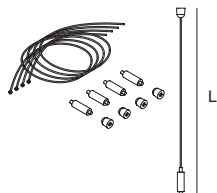

KIT n.4 SOSPENSIONI
per versioni 600x600 e 1200x300.

KIT nos.4 SUSPENSIONS
for 600x600 and 1200x300 versions.

CODE L (mm)

| | |
|-----------------|------|
| 16223.99 | 3000 |
|-----------------|------|

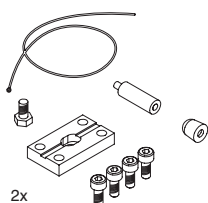

KIT n.2 GIUNTI + SOSPENSIONI
per versioni 600x600 e 1200x300.

KIT nos.2 JOINTS + SUSPENSIONS
for 600x600 and 1200x300 versions.

CODE L (mm)

| | |
|-----------------|------|
| 16227.96 | 3000 |
|-----------------|------|

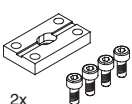

KIT n.2 GIUNTI (privi di sospensioni)
per versioni 600x600 e 1200x300.

KIT nos.2 JOINTS (without suspensions)
for 600x600 and 1200x300 versions.

CODE

| |
|-----------------|
| 16232.96 |
|-----------------|

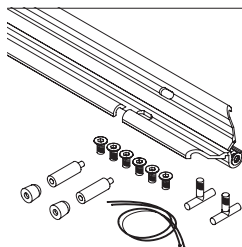

KIT SNODO + n.2 SOSPENSIONI
per versione 600x600
profilo in lega di alluminio verniciato.

KIT HINGE + nos.2 SUSPENSIONS
for 600x600 version
profile in powder coated aluminium alloy.

CODE L (mm)

| | |
|-----------------|------|
| 16228.01 | 3000 |
|-----------------|------|

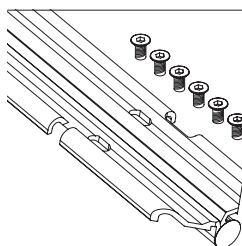

KIT SNODO (privo di sospensioni)
per versione 1200x300
profilo in lega di alluminio verniciato.

KIT HINGE (without suspensions)
for 1200x300 version
profile in powder coated aluminium alloy.

CODE

| |
|-----------------|
| 16234.01 |
|-----------------|

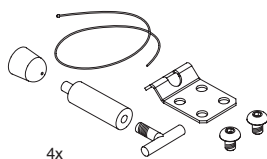

KIT n.4 SOSPENSIONI INCLINATE
per versioni 600x600 e 1200x300

KIT nos.4 INCLINED SUSPENSIONS
for 600x600 and 1200x300 versions

CODE L (mm)

| | |
|-----------------|------|
| 16230.99 | 3000 |
|-----------------|------|

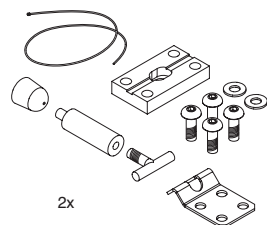

KIT n.2 GIUNTI + SOSPENSIONI +
STAFFE INCLINATE
per versione 600x600.

KIT nos.2 JOINTS + SUSPENSIONS +
INCLINED BRACKETS
for 600x600 version.

CODE L (mm)

| | |
|-----------------|------|
| 16231.96 | 3000 |
|-----------------|------|

THE PANEL 2

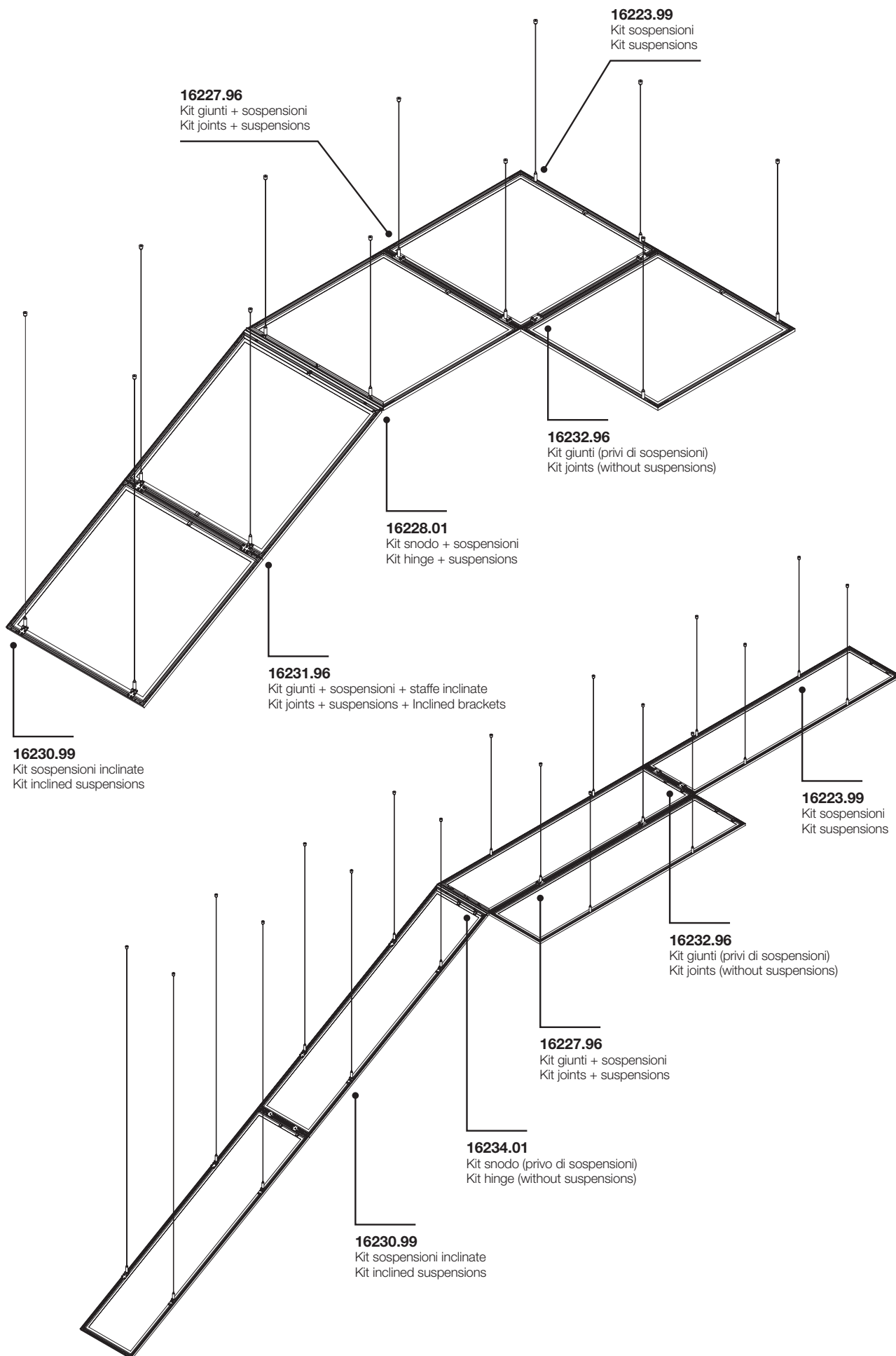
COMPOSIZIONI SOPPESE
SUSPENDED COMPOSITIONS

THE PANEL 2

ACCESSORI PER INSTALLAZIONE A BINARIO ACCESSORIES FOR TRACK MOUNTED

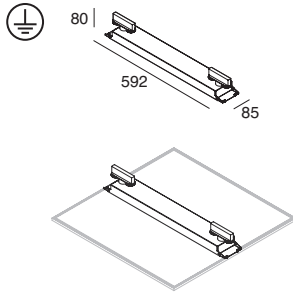

KIT BINARIO 600x600
completo di 2 adattatori
(elettrico/meccanico)
per binario elettrificato All-Track.

KIT FOR TRACK MOUNTING 600x600
supplied with 2 adaptors
(electrical/mechanical)
for electrified All-Track.

| CODE | VERSION |
|------------------|---------|
| 102055.01 | 3P+DALI |
| 102053.01 | 3P |

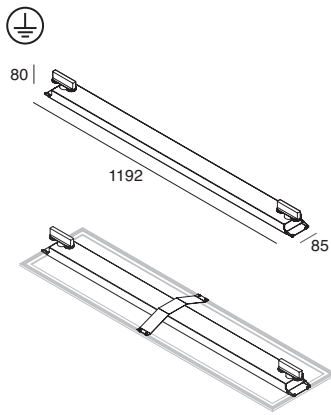

KIT BINARIO 1200x300
completo di 2 adattatori
(elettrico/meccanico)
per binario elettrificato All-Track.

KIT FOR TRACK MOUNTING 1200x300
supplied with 2 adaptors
(electrical/mechanical)
for electrified All-Track.

| CODE | VERSION |
|------------------|---------|
| 102056.01 | 3P+DALI |
| 102054.01 | 3P |

THE PANEL 2

ACCESSORI EMERGENZA ACCESSORIES EMERGENCY

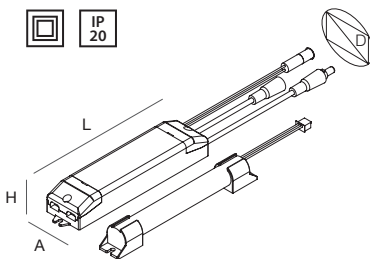

KIT DI ALIMENTAZIONE IN EMERGENZA
Per versioni 600x600 e 1200x300, per
installazione ad incasso o a plafone con Box
(102086.01, 102087.01).
Completo di connettori polarizzati per il
collegamento dell'alimentatore.

KIT FOR EMERGENCY
For 600x600 and 1200x300 versions,
for recessed installation or ceiling installation
with Box (102086.01, 102087.01)
Polarized connectors included.

| CODE | TIME CHARGE | A (mm) | D (mm) | H (mm) | L (mm) |
|------------------|-------------|--------|--------|--------|--------|
| 1020A4.99 | 1h 12h | 38 | 44 | 25 | 164 |
| 1020A5.99 | 3h 12h | 38 | 44 | 25 | 164 |

| Flusso in emergenza - Emergency flux | | 1h | 3h |
|--------------------------------------|------------|------------|-----------|
| THE PANEL 2 | 35W | 12% | 5% |
| THE PANEL 2 MICROPRISMATICO | 35W | 12% | 5% |