

TEK STAND ALONE

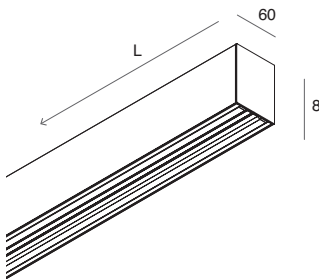

Apparecchio LED lineare per installazione singola, a plafone o sospensione. Disponibile nelle versioni con ottica ad emissione diffusa 90°, batwing e UGR<19. Corpo in lega di alluminio estruso verniciato a polvere bianco texturizzato, testate terminali in alluminio pressofuso, lenti lineari stampate in PMMA. Alimentazione elettronica 220-240V 50/60Hz integrata.

Stand alone LED linear fixture for ceiling or suspended installation. Available in versions with diffused emission optics 90°, batwing and UGR<19. Extruded aluminium alloy body with textured white powder coating, die-cast aluminium end heads, PMMA printed linear lenses. Integrated electronic power supply 220-240V 50/60Hz.



MODULO STAND ALONE LED 90°

Non installabile in fila continua. Alimentatore elettronico, lente lineare 90° e testate terminali, inclusi. Cavi di sospensione e kit di alimentazione da ordinare a parte.

STAND ALONE LED MODULE 90°

Not to be installed in a continuous line. Electronic power supply, linear lens 90° and terminal heads included. Suspension cables and power kit to be ordered separately.

| POWER | L (mm) | FLUX | 4000K <input type="checkbox"/> |
|-------|--------|---------|--------------------------------|
| 50W | 1693 | 6144 lm | 107019.01 |

DALI-PUSH

| POWER | L (mm) | 4000K <input type="checkbox"/> |
|-------|--------|--------------------------------|
| 50W | 1693 | 6144 lm 107022.01 |

* **EMERGENCY 1h** Flusso in emergenza / Emergency flux 10%

| POWER | L (mm) | 4000K <input type="checkbox"/> |
|-------|--------|--------------------------------|
| 50W | 1693 | 6144 lm 107025.01 |

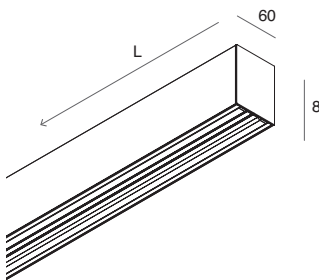

MODULO STAND ALONE LED BATWING

Non installabile in fila continua. Alimentatore elettronico, lente lineare batwing e testate terminali, inclusi. Cavi di sospensione e kit di alimentazione da ordinare a parte.

STAND ALONE BATWING LED MODULE

Not to be installed in a continuous line. Electronic power supply, batwing linear lens and terminal heads included. Suspension cables and power kit to be ordered separately.

| POWER | L (mm) | FLUX | 4000K <input type="checkbox"/> |
|-------|--------|---------|--------------------------------|
| 50W | 1693 | 6254 lm | 107020.01 |

DALI-PUSH

| POWER | L (mm) | 4000K <input type="checkbox"/> |
|-------|--------|--------------------------------|
| 50W | 1693 | 6254 lm 107023.01 |

* **EMERGENCY 1h** Flusso in emergenza / Emergency flux 10%

| POWER | L (mm) | 4000K <input type="checkbox"/> |
|-------|--------|--------------------------------|
| 50W | 1693 | 6254 lm 107026.01 |

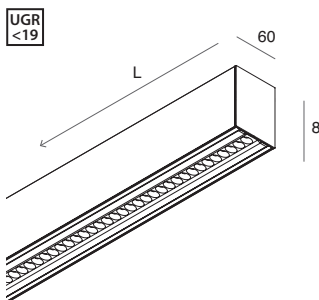

MODULO STAND ALONE LED UGR<19

Non installabile in fila continua. Alimentatore elettronico, lente lineare per il controllo dell'abbagliamento e testate terminali, inclusi. Cavi di sospensione e kit di alimentazione da ordinare a parte.

STAND ALONE LED MODULE UGR<19

Not to be installed in a continuous line. Electronic power supply, linear glare control lens and terminal heads included. Suspension cables and power kit to be ordered separately.

| POWER | L (mm) | FLUX | 4000K <input type="checkbox"/> |
|-------|--------|---------|--------------------------------|
| 36W | 1693 | 4949 lm | 107021.01 |

DALI-PUSH

| POWER | L (mm) | 4000K <input type="checkbox"/> |
|-------|--------|--------------------------------|
| 36W | 1693 | 4949 lm 107024.01 |

* **EMERGENCY 1h** Flusso in emergenza / Emergency flux 13%

| POWER | L (mm) | 4000K <input type="checkbox"/> |
|-------|--------|--------------------------------|
| 36W | 1693 | 4949 lm 107027.01 |

* Autonomia 1h / Ricarica 12h
Autonomy 1h / Charging 12h

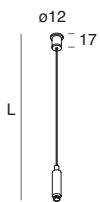

CAVO DI SOSPENSIONE (1 pz.)
In acciaio, regolabile.
Prevedere 2 pz per ciascun modulo.

SUSPENSION CABLE (1 pc)
In steel, adjustable.
Provide 2 pcs for each module.

| CODE | L (mm) |
|-----------------|--------|
| 10865.99 | 3000 |

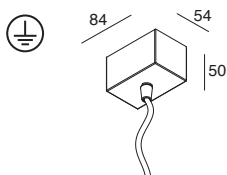

KIT DI ALIMENTAZIONE
Cavo di alimentazione trasparente

POWER SUPPLY KIT
Transparent power cable

| CODE | L (mm) | Cavo / Cable (mm²) |
|------------------|--------|--------------------|
| 108920.01 | 3000 | 3x1,5 |
| 108922.01 | 3000 | 5x1,5 |

TEK
FILA CONTINUA

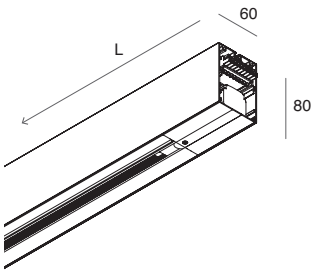

MODULO BINARIO ALL-TRACK

Binario elettrificato TRIFASE 7 poli, con due conduttori dedicati D+D- per segnale DALI, 0-10V o 1-10V, integrato.

Non utilizzabile comando di dimmerazione a pulsante a 230V. La funzione PUSH è ammessa solo con interposizione di interfaccia pulsante con uscita DALI (cod. 18908.99 oppure 18906.99), si veda sezione GESTIONE LUCE.

Giunti meccanici/elettrici inclusi.

Accessori per ingresso alimentazione, testata terminale e kit di sospensione da ordinare a parte.

L (mm)

1689



107012.01

ALL-TRACK MODULE

Three-phase 7-pole electrified track, with two dedicated D+ D- conductors for DALI signal, 0-10V or 1-10V, integrated.

230V push-button dimming control not available. The PUSH function is only allowed with button interface interposition with DALI output. (cod. 18908.99 or 18906.99), see section Light Management.

Mechanical/electrical joints included.

Accessories for power input, terminal head and suspension kit to be ordered separately.

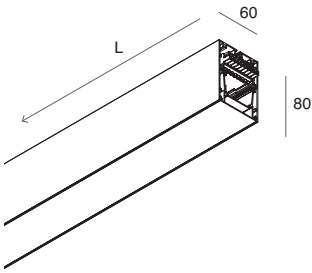

MODULO CIECO CABLATO

Provisto di connessione rapida per cablaggio passante 9 poli.

Schermo cieco in lega di alluminio verniciato e giunti meccanici/elettrici inclusi.

Accessori per ingresso alimentazione, testata terminale e kit di sospensione da ordinare a parte.

L (mm)

563



107029.01

1126

107028.01

1689

107007.01

EMPTY MODULE WIRED

Provided with quick connection for 9-pole through wiring.

Painted aluminum alloy blind screen and mechanical/electrical joints included.

Accessories for power input, terminal head and suspension kit to be ordered separately.

107010.01

107011.01

107010.01

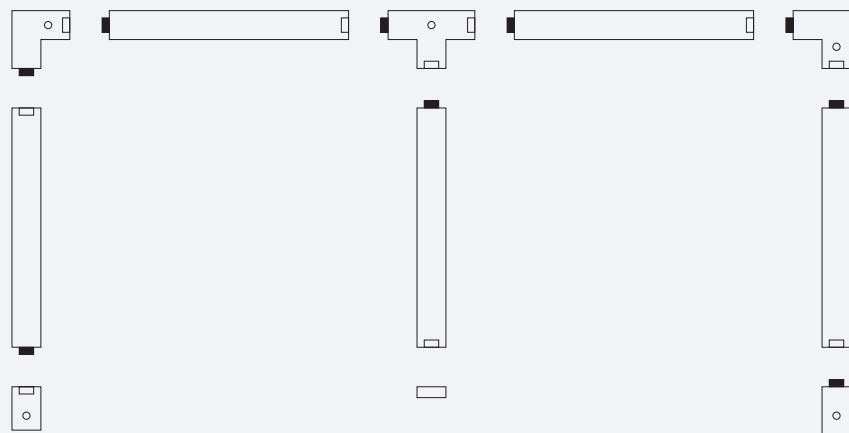

107008.01

107013.01

107009.01

Moduli fila continua
 Continuous line modules



107013.01

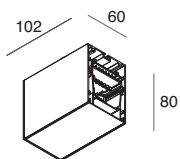

ALIMENTAZIONE DI TESTA
9 poli
cavo di alimentazione non fornito.

CODE **107008.01**

START LIVE END
9 poles
power supply cable not provided.

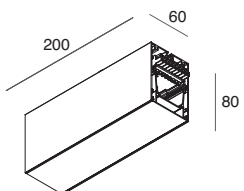

ALIMENTAZIONE CENTRALE
9 poli
cavo di alimentazione non fornito.

CODE **107009.01**

CENTRAL FEED JOINT
9 poles
power supply cable not provided.

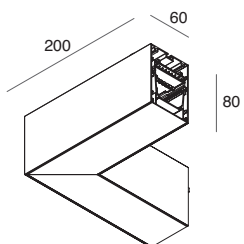

GIUNTO a L
alimentabile, 9 poli
cavo di alimentazione non fornito.

CODE **107010.01**

L-feed JOINT
9 poles
power supply cable not provided.

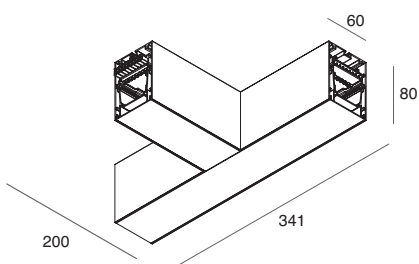

GIUNTO a T
alimentabile, 9 poli
cavo di alimentazione non fornito.

CODE **107011.01**

T-feed JOINT
9 poles
power supply cable not provided.

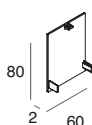

TESTATA TERMINALE (1 pz.)

DEAD END (1 pc)

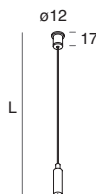
CODE **107013.01**

CAVO DI SOSPENSIONE (1 pz.)
Da prevedere ad inizio e fine linea continua
e 2 pz. per installazione singola.
In acciaio, regolabile.

CODE L (mm)**108685.99** 3000

SUSPENSION CABLE (1 pc)
To be provided at start and end of line
continuous and 2 pcs. for single installation.
In steel, adjustable.



CAVO DI SOSPENSIONE GIUNZIONE (1 pz.)
Per unione moduli.
In acciaio, regolabile.

CODE L (mm)**107015.99** 3000

JOINT SUSPENSION CABLE (1pc)
For modules union.
In steel, adjustable.