

L-09

LE GARANZIE PRODOTTO SARANNO APPLICABILI, PER RAGIONI DI SICUREZZA E FRUIBILITÀ, SOLO UTILIZZANDO STRIPLED ED ALIMENTAZIONI NOVALUX. THE PRODUCT WARRANTY CONDITIONS WILL APPLY, DUE TO REASONS OF SAFETY AND QUALITY OF USE, ONLY WHEN INSTALLED WITH THE STRIPLED AND DRIVERS FROM NOVALUX CATALOGUES.



Profilo per Strip LED tagliabile in opera, per realizzare linee di luce incassate nel cartongesso.
 Corpo in cartongesso di spessore 12,5 mm da lastra standard o HYDRO (a ridotto assorbimento di acqua, utilizzabile in ambienti con umidità relativa costante dell'aria $\leq 70\%$).
 Profilo dissipante in lega di alluminio anodizzato naturale e schermo di protezione in PMMA opale inclusi.
 Strip LED e alimentatore elettronico 24Vdc remoto da ordinare a parte.
 Non esporre a intemperie o luce solare diretta e non inserire in materiale isolante.

Profile for Strip LED, for light cut on plasterboard.
 Body made of 12,5 mm thick plasterboard, either standard or HYDRO treated (with reduced water absorption level to be used in environments with constant relative humidity levels of air $\leq 70\%$).
 Dissipating profile made of anodized aluminium alloy natural finish and PMMA opal diffuser included.
 Strip LED and remote electronic driver 24Vdc to be ordered separately.
 Do not expose to bad weather or direct sunlight and do not insert into insulating material.

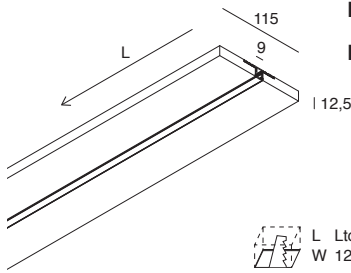

PROFILO LINEARE
LINEAR PROFILE

CODE	L (mm)	Version
101898.99	2000	Standard
101899.99	2000	HYDRO

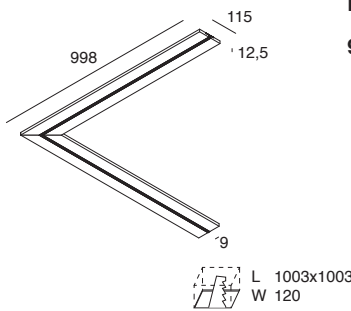

PROFILO ANGOLARE 90°
90° CORNER PROFILE

CODE	L (mm)	Version
1018A0.99	998x998	Standard
1018A1.99	998x998	HYDRO

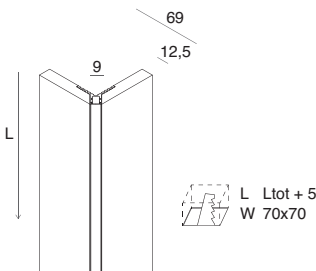

L-09 CORNER
profilo lineare per spigolo esterno non installabile direttamente su muratura

L-09 CORNER
linear profile for external corner not for direct installation on hard surfaces

CODE	L (mm)	Version
1018A8.99	2000	Standard
1018A9.99	2000	HYDRO

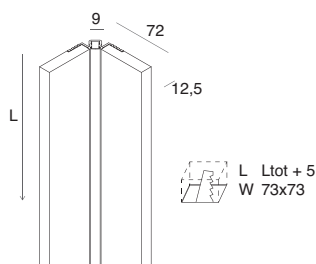

L-09 EDGE
profilo lineare per spigolo interno

L-09 EDGE
linear profile for internal corner

CODE	L (mm)	Version
1018A6.99	2000	Standard
1018A7.99	2000	HYDRO

L-09 WALL

LE GARANZIE PRODOTTO SARANNO APPLICABILI, PER RAGIONI DI SICUREZZA E FRUIBILITÀ, SOLO UTILIZZANDO STRIPLED ED ALIMENTAZIONI NOVALUX. THE PRODUCT WARRANTY CONDITIONS WILL APPLY, DUE TO REASONS OF SAFETY AND QUALITY OF USE, ONLY WHEN INSTALLED WITH THE STRIPLED AND DRIVERS FROM NOVALUX CATALOGUES.



Profilo per Strip LED tagliabile in opera, per realizzare linee di luce incassate in muratura.

Profilo tagliabile in opera in lega di alluminio anodizzata naturale e rete di armatura porta-intonaco in acciaio zincato.

Schermo di protezione in PMMA opale incluso.

Strip LED e alimentatore elettronico remoto da ordinare a parte.

Non esporre a intemperie o luce solare diretta e non inserire in materiale isolante.

Profile for Strip LED for light cut on concrete or brick surface.

Length cuttable on measure on site.

Profile made of aluminium alloy and galvanized steel grid to plaster.

PMMA protection screen included.

Strip LED and remote electronic driver to be ordered separately.

Do not expose to bad weather or direct sunlight and do not insert into insulating material.

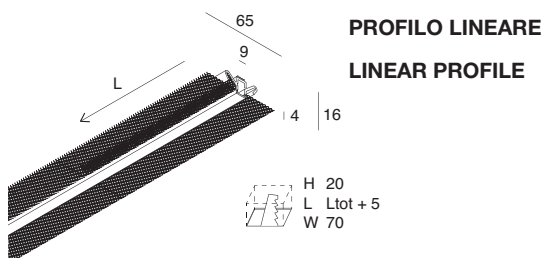

PROFILO LINEARE

LINEAR PROFILE

CODE L (mm)

1018B0.99 2000

L-09 L-09 WALL

ACCESSORI ACCESSORIES

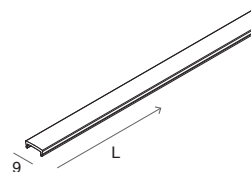

SCHERMO OPALE 6 m
opzionale
Consigliato per installazioni in fila continua

OPAL SCREEN 6 m
optional
Recommended for continuous line installations

CODE L (mm)

1018A2.99 6000 Opale / Opal

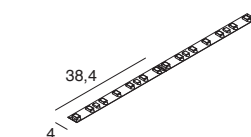

STRIP LED 4mm
11,5W/m

SMD 2216 (182 LED/m)
Biadesivo - sezionabile ogni 38,4 mm (7 LED)
Biadhesive - cuttable every 38,4 mm (7 LED)

CODE L (mm) LED COLOUR FLUX/m IP CRI

100913.99 5000 2700K 1100 20 90

100914.99 5000 3000K 1014 20 90

100915.99 5000 4000K 1154 20 90

100928.99 5000 2700K 1016 65 90

100929.99 5000 3000K 1038 65 90

100930.99 5000 4000K 1124 65 90