

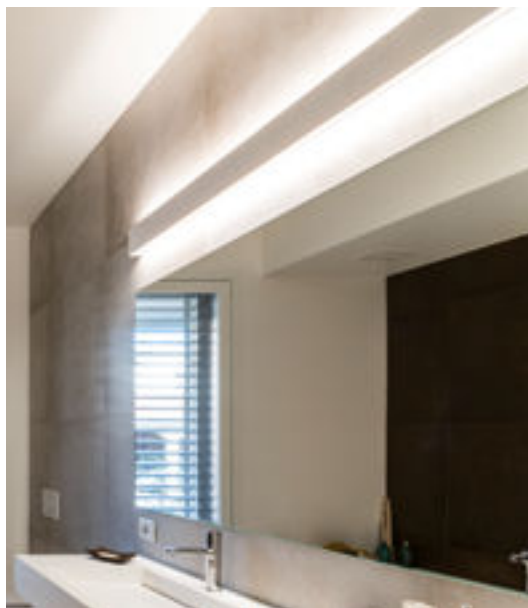

R E C T A



RECTA

Soluzione illuminotecnica elegante e funzionale: applicazione a parete dal design minimal e lineare. RECTA è un apparecchio luminoso Novalux a emissione di luce diretta e indiretta, componibile in fila continua, nella versione con PCB LED integrato oppure con Strip LED, tagliabile su misura. Sistema d'illuminazione perfetto per spazi comuni e per i settori residenziale e ricettivo, disponibile nei colori bianco, nero, caffè e cappuccino.

Elegant and functional lighting solution: wall mounting with a pure and linear design RECTA is a Novalux luminaire emitting direct and indirect light, modular in a continuous line, in the version with built-in LED PCB or LED strip, that can be cut to size. Ideal Lighting system for common areas and the residential and hospitality sectors, available in white, black, coffee and cappuccino colours.

RECTA STRIP LED

Profilo vuoto tagliabile su misura.

Hollow profile, cuttable to size.

Alimentatori integrabili nel profilo per singola o doppia accensione.

Drivers can be integrated into the profile for single or double switching.

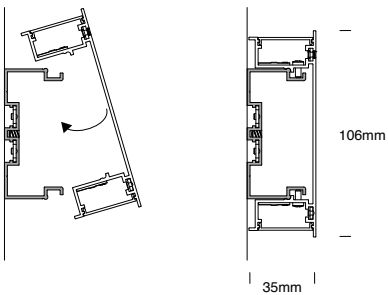

Sistema di montaggio intuitivo con un profilo da parete che supporta il profilo a vista tramite fissaggi nascosti.

Intuitive mounting system with a wall-mounted profile that supports the visible profile through concealed fixings.

RECTA PCB

Profilo completo di LED PCB.

Profile complete with LED PCB.

Alimentatore integrato.

Integrated driver.



Profilo in alluminio disponibile in 4 finiture: **caffè, cappuccino, bianco e nero.**

Aluminum profile available in 4 finishes: **coffee, cappuccino, white and black.**

ILLUMINAZIONE
LINEARE,
SEMPLICE,
RECTA.

LINEAR
LIGHTING,
SIMPLE,
RECTA.



SYSTEMS



RECTA PCB



Sistema lineare con LED integrati a luce diretta/indiretta per installazione a parete. Profilo e testate in lega di alluminio verniciata, schermi diffusori in policarbonato opale. Alimentatore elettronico, schermi diffusori e kit di giunzione inclusi. Testate terminali da ordinare a parte.

Linear system with integrated LED for direct/indirect light emission, for wall mounting. Profile and end caps made of painted aluminium alloy and diffuser made of opal polycarbonate. Electronic driver, diffusers and junction kit included. End caps to be ordered separately.

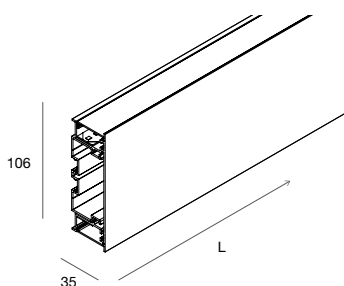

PROFILO LINEARE PCB

LINEAR PROFILE PCB

2700K

L (mm)								
600	2x12W	111401_..	01	1877 lm	02	20	21	1364 lm
1200	2x23W	111407_..	01	3754 lm	02	20	21	2729 lm

3000K

L (mm)								
600	2x12W	111402_..	01	1997 lm	02	20	21	1452 lm
1200	2x23W	111408_..	01	3994 lm	02	20	21	2904 lm

4000K

L (mm)								
600	2x12W	111403_..	01	2076 lm	02	20	21	1510 lm
1200	2x23W	111409_..	01	4153 lm	02	20	21	3020 lm

DALI-PUSH

2700K

L (mm)								
600	2x12W	111404_..	01	1877 lm	02	20	21	1364 lm
1200	2x23W	111410_..	01	3754 lm	02	20	21	2729 lm

3000K

L (mm)								
600	2x12W	111405_..	01	1997 lm	02	20	21	1452 lm
1200	2x23W	111411_..	01	3994 lm	02	20	21	2904 lm

4000K

L (mm)								
600	2x12W	111406_..	01	2076 lm	02	20	21	1510 lm
1200	2x23W	111412_..	01	4153 lm	02	20	21	3020 lm

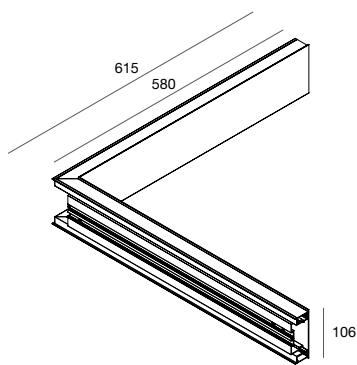

PROFILO ANGOLARE INTERNO PCB
INTERNAL CORNER PROFILE PCB

2700K						
L (mm)	<input type="checkbox"/>	<input checked="" type="checkbox"/>	<input checked="" type="checkbox"/>	<input checked="" type="checkbox"/>		
615x615 2x23W	111413...	01	3754 lm	02	20	21 2729 lm
3000K						
L (mm)	<input type="checkbox"/>	<input checked="" type="checkbox"/>	<input checked="" type="checkbox"/>	<input checked="" type="checkbox"/>		
615x615 2x23W	111414...	01	3994 lm	02	20	21 2904 lm
4000K						
L (mm)	<input type="checkbox"/>	<input checked="" type="checkbox"/>	<input checked="" type="checkbox"/>	<input checked="" type="checkbox"/>		
615x615 2x23W	111415...	01	4153 lm	02	20	21 3020 lm

DALI-PUSH

2700K						
L (mm)	<input type="checkbox"/>	<input checked="" type="checkbox"/>	<input checked="" type="checkbox"/>	<input checked="" type="checkbox"/>		
615x615 2x23W	111416...	01	3754 lm	02	20	21 2729 lm
3000K						
L (mm)	<input type="checkbox"/>	<input checked="" type="checkbox"/>	<input checked="" type="checkbox"/>	<input checked="" type="checkbox"/>		
615x615 2x23W	111417...	01	3994 lm	02	20	21 2904 lm
4000K						
L (mm)	<input type="checkbox"/>	<input checked="" type="checkbox"/>	<input checked="" type="checkbox"/>	<input checked="" type="checkbox"/>		
615x615 2x23W	111418...	01	4153 lm	02	20	21 3020 lm

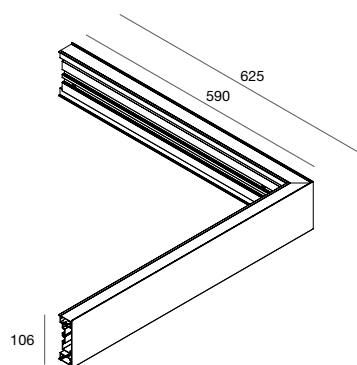

PROFILO ANGOLARE ESTERNO PCB
EXTERNAL CORNER PROFILE PCB

2700K						
L (mm)	<input type="checkbox"/>	<input checked="" type="checkbox"/>	<input checked="" type="checkbox"/>	<input checked="" type="checkbox"/>		
625x625 2x23W	111419...	01	3754 lm	02	20	21 2729 lm
3000K						
L (mm)	<input type="checkbox"/>	<input checked="" type="checkbox"/>	<input checked="" type="checkbox"/>	<input checked="" type="checkbox"/>		
625x625 2x23W	111420...	01	3994 lm	02	20	21 2904 lm
4000K						
L (mm)	<input type="checkbox"/>	<input checked="" type="checkbox"/>	<input checked="" type="checkbox"/>	<input checked="" type="checkbox"/>		
625x625 2x23W	111421...	01	4153 lm	02	20	21 3020 lm

DALI-PUSH

2700K						
L (mm)	<input type="checkbox"/>	<input checked="" type="checkbox"/>	<input checked="" type="checkbox"/>	<input checked="" type="checkbox"/>		
625x625 2x23W	111422...	01	3754 lm	02	20	21 2729 lm
3000K						
L (mm)	<input type="checkbox"/>	<input checked="" type="checkbox"/>	<input checked="" type="checkbox"/>	<input checked="" type="checkbox"/>		
625x625 2x23W	111423...	01	3994 lm	02	20	21 2904 lm
4000K						
L (mm)	<input type="checkbox"/>	<input checked="" type="checkbox"/>	<input checked="" type="checkbox"/>	<input checked="" type="checkbox"/>		
625x625 2x23W	111424...	01	4153 lm	02	20	21 3020 lm

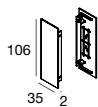
RECTA
PCB

TESTATE TERMINALI (2 pz.)

END CAPS (2 pcs)

ACCESSORI
ACCESSORIES

	<input type="checkbox"/>	<input checked="" type="checkbox"/>	<input checked="" type="checkbox"/>	<input checked="" type="checkbox"/>
111428...	01	02	20	21

RECTA STRIP LED



Sistema lineare per strip LED a luce diretta/indiretta per installazione a parete. Profilo tagliabile in opera e testate in lega di alluminio verniciata, schermi diffusori in policarbonato opale. Schermi diffusori e kit di giunzione inclusi. Testate terminali, strip LED e alimentatore elettronico da ordinare a parte.

Linear system for LED strip for direct/indirect light, for wall mounting. Profile to be cut on site and end caps made of painted aluminum alloy, diffusers made of opal polycarbonate. Diffusers and junction kit included. End caps, LED strip and electronic driver to be ordered separately.

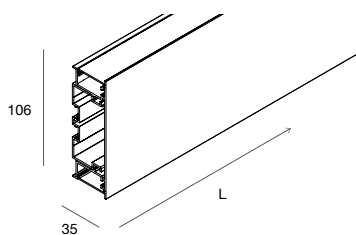

PROFILO LINEARE
PER STRIP LED

LINEAR PROFILE
FOR STRIP LED

□ ■ ● ● L (mm)
111425._ _ 01 02 20 21 1800

RECTA STRIP LED

ACCESSORI ACCESSORIES

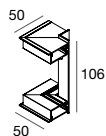

GIUNTO ANGOLARE INTERNO
Schermi diffusori opali inclusi

INNER ANGLE JOINT
Opal diffusers included

□ ■ ● ●
111426._ _ 01 02 20 21

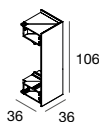

GIUNTO ANGOLARE ESTERNO
Schermi diffusori opali inclusi

OUTER ANGLE JOINT
Opal diffusers included

□ ■ ● ●
111427._ _ 01 02 20 21

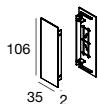

TESTATE TERMINALI (2 pz.)

END CAPS (2 pcs)

□ ■ ● ●
111428._ _ 01 02 20 21

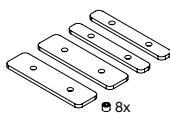

KIT DI GIUNZIONE

Da prevedere in caso di taglio in opera del profilo lineare e recupero della parte rimanente.

JUNCTION KIT

To be provided in case of cutting the linear profile and reuse of the remaining part.

111429.99

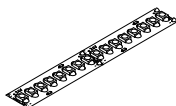

STRIP LED

Pag. 558

Installabile 1 strip LED di larghezza max 10mm per vano ottico.
1 LED strip of maximum width 10mm can be mounted for each optical compartment.

RECTA STRIP LED

ALIMENTATORI E INTERFACCE DI DIMMERAZIONE 24Vdc/48Vdc INSERIBILI NEL PROFILO DRIVERS AND DIMMING INTERFACES 24Vdc/48Vdc CAN BE HOUSED IN THE PROFILE

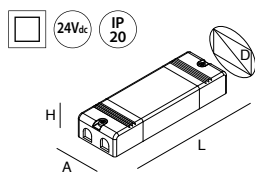

ALIMENTATORI 24Vdc
Vedi sezione Gestione Luce

		A (mm)	D (mm)	H (mm)	L (mm)
101352.99	60W	30	35	17	305
101361.99	100W	30	34	16	251

DRIVERS 24Vdc
See section Light Management

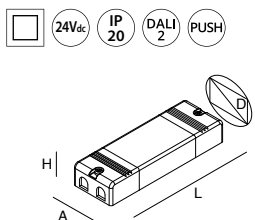

ALIMENTATORE ELETTRONICO
STABILIZZATO
DIMMERABILE 4CH DALI DT6/DT8 24Vdc
220-240V 50/60Hz
Gestione DALI/PUSH per Strip LED bianche.
Gestione DALI per Strip LED RGB/RGBW e
Tunable White.

		A (mm)	D (mm)	H (mm)	L (mm)
101318.99	80W	32	40	22	346

ELECTRONIC STABILIZED DIMMABLE DRIVER
4CH DALI DT6/DT8 24Vdc 220-240V 50/60Hz
DALI/PUSH for white strip LED.
DALI for RGB/RGBW and Tunable White.

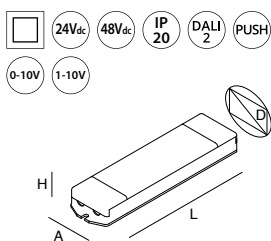

INTERFACCIA DI DIMMERAZIONE
24Vdc/48Vdc
PER STRIP LED
Massimo carico 12Ax1 canale.
Da associare ad un alimentatore
24Vdc/48Vdc.

		A (mm)	D (mm)	H (mm)	L (mm)
105914.99		38	44	25	164

INTERFACE FOR DIMMING 24Vdc/48Vdc
FOR STRIP LED
Maximum load 12Ax1CH.
To be associated with one driver
24Vdc/48Vdc.

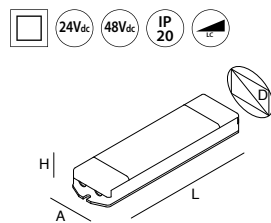

INTERFACCIA DI DIMMERAZIONE
24Vdc/48Vdc
A TAGLIO DI FASE PER STRIP LED
Massimo carico 10A.
Da associare ad un alimentatore
24Vdc/48Vdc.

		A (mm)	D (mm)	H (mm)	L (mm)
105923.99		36	41	20	140

INTERFACE FOR DIMMING 24Vdc/48Vdc
PHASE CUT FOR LED STRIP
Maximum load 10A.
To be associated with one driver
24Vdc/48Vdc.

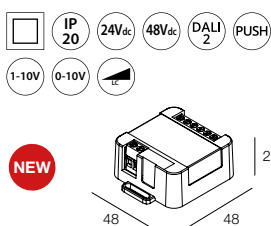

INTERFACCIA DI DIMMERAZIONE 24Vdc/48Vdc
PER STRIP LED o sistemi compatibili a tensione
costante. Massimo carico 12Ax1 canale. Da
associare ad un alimentatore 24Vdc/48Vdc.
Master/slave fino a 10 unità. Vedere istruzioni per
la compatibilità con sistemi di controllo.

		A (mm)	D (mm)	H (mm)	L (mm)
105937.99		48	-	23	48

INTERFACE FOR DIMMING 24Vdc/48Vdc
For LED strips or with constant-voltage
compatible systems. Maximum load 12Ax1
channel. To be associated with a 24Vdc/48Vdc
driver. Master/slave up to 10 units. Refer to the
instructions for compatibility with control systems.