

PROFILED FLEX

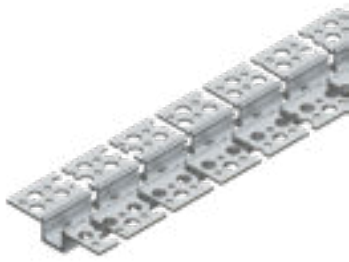

Profilo curvabile per Strip LED FLEX, in lega di alluminio anodizzata naturale, per installazione da incasso a rasamento in cartongesso. Da prevedere stucco di finitura di alto spessore. Curvatura del profilo possibile solo sul piano orizzontale, con raggio maggiore di 30 cm. Strip LED FLEX e alimentatore elettronico 24Vdc da ordinare a parte.

Bendable profile for FLEX LED Strips, made of natural anodized aluminum alloy, designed for flush recessed installation in plasterboard. Requires thick finishing plaster. Profile bending is possible only on the horizontal plane, with a radius greater than 30 cm. FLEX LED Strip and 24Vdc electronic driver to be ordered separately.

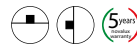

L Ltot
W 25

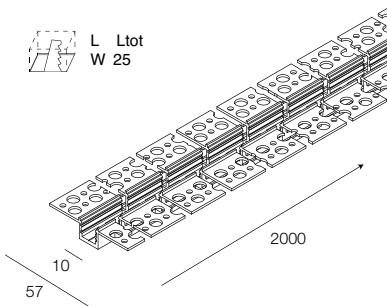

	L (mm)
105427.96	2000



STRIP LED FLEX



Tubo LED IP65 in silicone flessibile ecologico, da abbinare esclusivamente a PROFILED FLEX, sezionabile ogni ca. 35mm. Cavo di alimentazione L.150mm incluso, su entrambe le estremità della bobina. In caso di taglio è necessario il ripristino della protezione IP ad opera dell'installatore. Dispositivo per installazione da interno. Non esporre a intemperie o luce solare diretta. Alimentazione elettronica o dimmerabile 24V, da ordinare a parte. Vedere sezione GESTIONE LUCE per sistemi di controllo strip LED 24V.

IP65 LED tube made of eco-friendly flexible silicone, designed to be used exclusively with PROFILED FLEX, and can be cut approximately every 35 mm. A 150 mm power cable is included on both ends of the reel. If cut, IP protection must be restored by the installer. For indoor installation only. Do not expose to weather conditions or direct sunlight. Electronic or dimmable 24V driver to be ordered separately. Refer to the LIGHT MANAGEMENT section for 24V LED strip control systems.

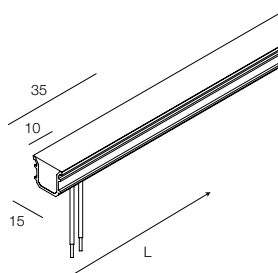

			lm/m	L (mm)	IP	CRI
1009A2.99	3000K	12W/m	952	2040	65	80
1009A3.99	4000K	12W/m	991	2040	65	80
1009A4.99	3000K	12W/m	952	5100	65	80
1009A5.99	4000K	12W/m	991	5100	65	80

STRIP LED FLEX

ACCESSORI ACCESSORIES

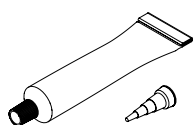

SIGILLANTE SILICONICO
Tubo da 60 ml di silicone neutro
trasparente resistente UV

100966.99

SILICONE SEALANT
60 ml tube of UV resistant
transparent neutral silicone

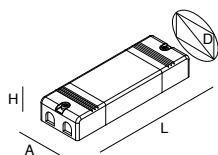

ALIMENTATORI 24Vdc
Pag. 562, 563 e 564
Vedere sezione GESTIONE LUCE
per sistemi di controllo.

DRIVERS 24Vdc
Pag. 562, 563 and 564
See section LIGHT MANAGEMENT
for control systems.

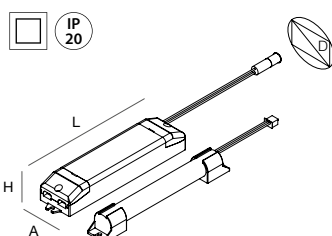

KIT DI EMERGENZA
da installare sul controsoffitto
a lato del prodotto.
Carico minimo 5W,
carico massimo 25W.

EMERGENCY KIT
to place on the false ceiling
next to the fixture.
Minimum power 5W,
maximum power 25W.

	TIME	CHARGE	A (mm)	D (mm)	H (mm)	L (mm)
18004.99	1h	12h	38	44	25	164
18005.99	3h	12h	38	44	25	164
Flusso in emergenza Emergency flux	1h (25W)	3h (25W)				
STRIP LED		17%	7%			