



LIMITLESS



LIMITLESS

Il nuovo sistema lineare Limitless è progettato per adattarsi con naturalezza a qualsiasi spazio architettonico, offrendo la massima libertà compositiva. Grazie alla varietà di snodi e moduli luminosi, consente di creare configurazioni praticamente illimitate, seguendo geometrie lineari, inclinate o completamente personalizzate. Un sistema versatile, robusto e altamente configurabile, pensato per trasformare la luce in un vero strumento progettuale.

The new Limitless linear system is designed to naturally adapt to any architectural space, offering maximum compositional freedom. Thanks to a wide range of joints and lighting modules, it allows for the creation of virtually unlimited configurations, following linear, angled or fully customized geometries. A versatile, robust and highly configurable system, conceived to transform light into a true design tool.

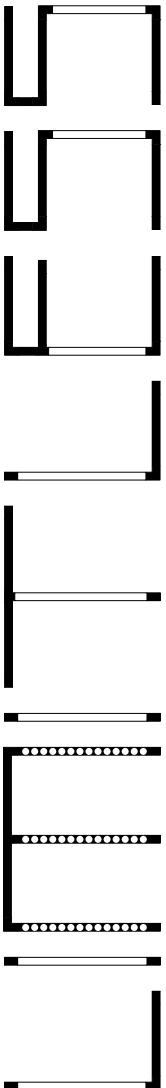



SYSTEMS



INSPIRATION



MODULI LINEARI LINEAR MODULES

48V

Carico massimo di alimentazione 240W
Maximum power input 240W



MODULO LED TUTTA LUCE
FULL LIGHT LED MODULE
L 492 mm / 924 mm / 1464 mm
8 W / 15 W / 25 W



MODULO LED MICROPRISMATICO
MICROPRISMATIC LED MODULE
L 492 mm / 924 mm / 1464 mm
14 W / 27 W / 44 W



MODULO LED MICROOTTICHE
MICRO-OPTICS LED MODULE
L 492 mm / 924 mm / 1464 mm
14 W / 27 W / 44 W



MODULO BINARIO
TRACK MODULE
L 492 mm / 924 mm / 1464 mm
SPOT LED / LED SPOTLIGHT 7 W



MODULO STRUTTURALE
STRUCTURAL MODULE
L 276 mm / 492 mm / 924 mm / 1464 mm





TESTATE / HEADS

È disponibile una gamma di diverse tipologie di testate: versioni predisposte per l'installazione a **sospensione**, oppure dotate di basetta per il fissaggio a **soffitto, parete** o a **terra**.

A range of different head options is available: versions designed for **suspended installation**, as well as versions equipped with a base for fixing to the **ceiling, wall, or floor**.

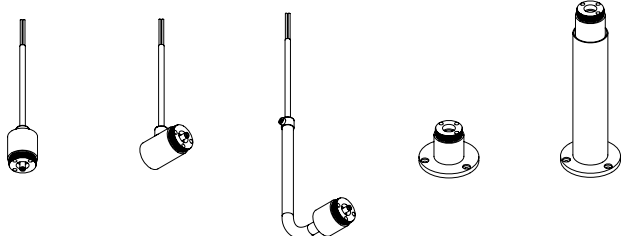

Le testate per fissaggio su superficie sono proposte con **connettore maschio** per il collegamento diretto ai profili lineari, oppure con **connettore femmina** per l'integrazione con giunti e la configurazione di composizioni articolate.

Surface-mounted heads are available with a **male connector** for direct connection to linear profiles, or with a **female connector** for integration with joints and the configuration of articulated compositions.

GIUNTI / JOINTS

La gamma di giunti è particolarmente ampia e consente di realizzare composizioni lineari o articolate offrendo la massima libertà progettuale e rispondendo a qualsiasi esigenza applicativa. **Le possibilità sono davvero SENZA LIMITI.**

The range of joints is particularly extensive, allowing for linear or more articulated compositions, offering maximum design freedom and meeting any application requirement. **The possibilities are truly LIMITLESS.**

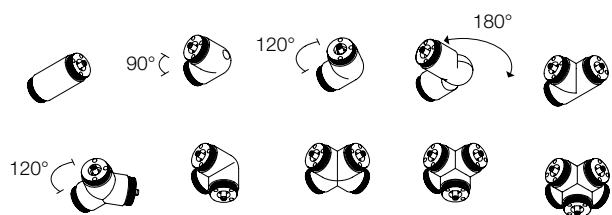

I giunti svolgono una funzione di **connessione sia meccanica che elettrica** e, alcune versioni, presentano più punti predisposti per il cavo di sospensione, consentendo **più possibilità di rotazione e di posizionamento** dello stesso giunto. In assenza di sospensione, i fori risultano chiusi con appositi tappi, assicurando la continuità estetica del sistema.

The joints perform **both a mechanical and electrical connection** function and, in some versions, feature multiple points designed for the suspension cable, allowing **greater flexibility in rotation and positioning** of the joint. When suspension is not used, the holes are closed with dedicated caps, ensuring the aesthetic continuity of the system.



Cablato o non cablato?

Wired or unwired?

Sia le testate che i giunti sono forniti in due configurazioni: con cavo di alimentazione integrato $2 \times 0,75 \text{ mm}^2$ oppure non cablate con eventuale predisposizione per cavo di sospensione, in modo da garantire la massima **flessibilità in funzione dell'ingresso dell'alimentazione** in ciascuna composizione.

Both the heads and the joints are supplied in two configurations: with an integrated $2 \times 0,75 \text{ mm}^2$ power cable or unwired, with optional provision for a suspension cable, ensuring maximum **flexibility according to the power supply entry point** within each composition.



SYSTEMS

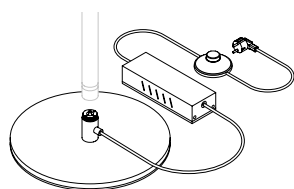

UNA PIANTANA PERSONALIZZATA A CUSTOMIZED FLOOR LAMP

Il sistema prevede inoltre una base che consente il montaggio di moduli lineari per la realizzazione di una piantana personalizzabile nella tipologia di sorgenti luminose installabili. La base è fornita completa di testata per modulo lineare, cavo di alimentazione con interruttore a pedale, alimentatore da 100W e spina Schuko, offrendo **una soluzione pronta all'uso, flessibile** e adatta a molteplici contesti applicativi.

The system also includes a base that allows the installation of linear modules to create a customizable floor lamp, with flexibility in the type of light sources that can be installed. The base is supplied complete with a head for the linear module, a power cable with foot switch, a 100W power supply, and a Schuko plug, offering **a ready-to-use, flexible solution** suitable for a wide range of application contexts.

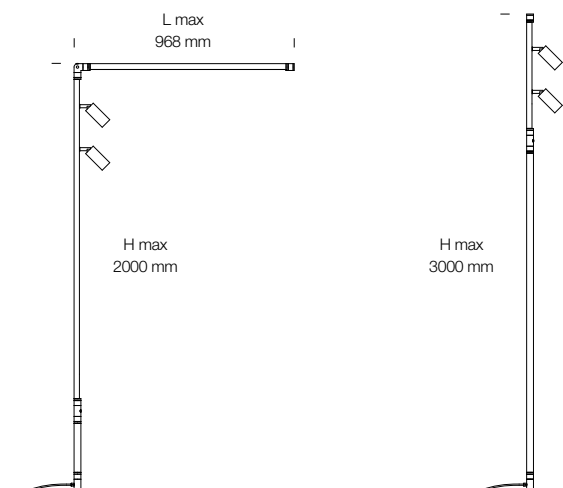

ASSEMBLAGGIO IMMEDIATO E SICURO QUICK AND SAFE ASSEMBLY

L'assemblaggio degli elementi lineari con giunti e testate avviene tramite avvitamento con filetto, **senza l'utilizzo di utensili**, garantendo un montaggio rapido e preciso. La connessione elettrica e meccanica risulta immediata e sicura, progettata per assicurare elevata **solidità strutturale e robustezza** all'intero sistema, e durabilità nel tempo.

The assembly of the linear elements with joints and end caps is carried out by threaded screw connection, **without the use of tools**, ensuring fast and precise installation. Both the electrical and mechanical connections are immediate and secure, designed to provide high **structural strength and robustness** to the entire system, as well as long-term durability.

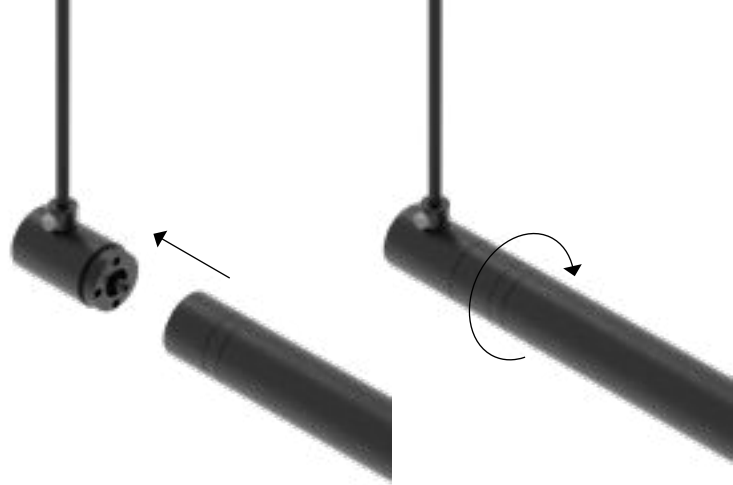

LIBERTÀ ASSOLUTA DI ROTAZIONE A 360° ABSOLUTE FREEDOM OF 360° ROTATION

La possibilità di ruotare e orientare ogni elemento permette di **dirigere la luce esattamente dove serve**, dando vita a scene luminose dinamiche e sempre diverse.

The ability to rotate and orient each element allows **the light to be directed exactly where it is needed**, creating dynamic and ever-changing lighting scenes.

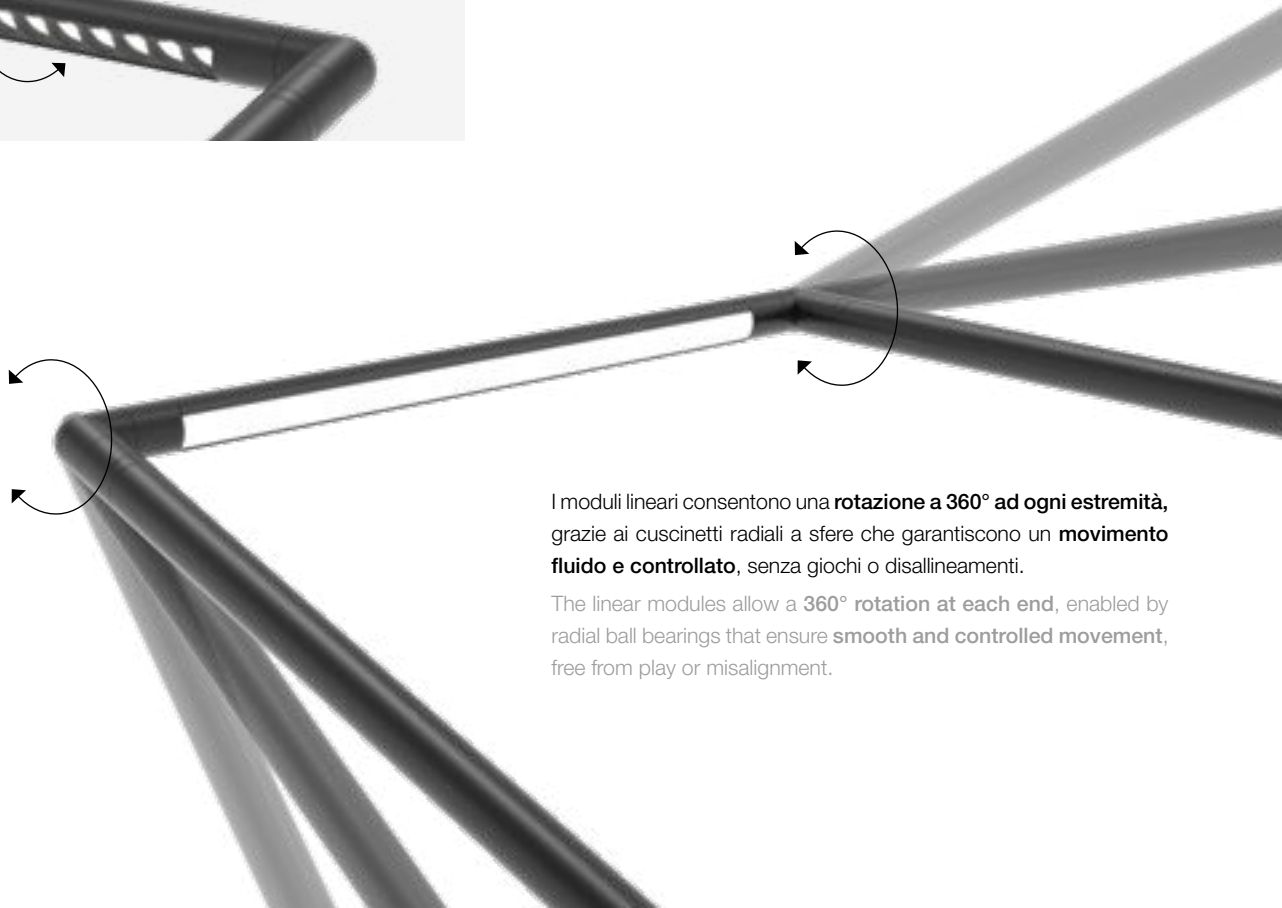
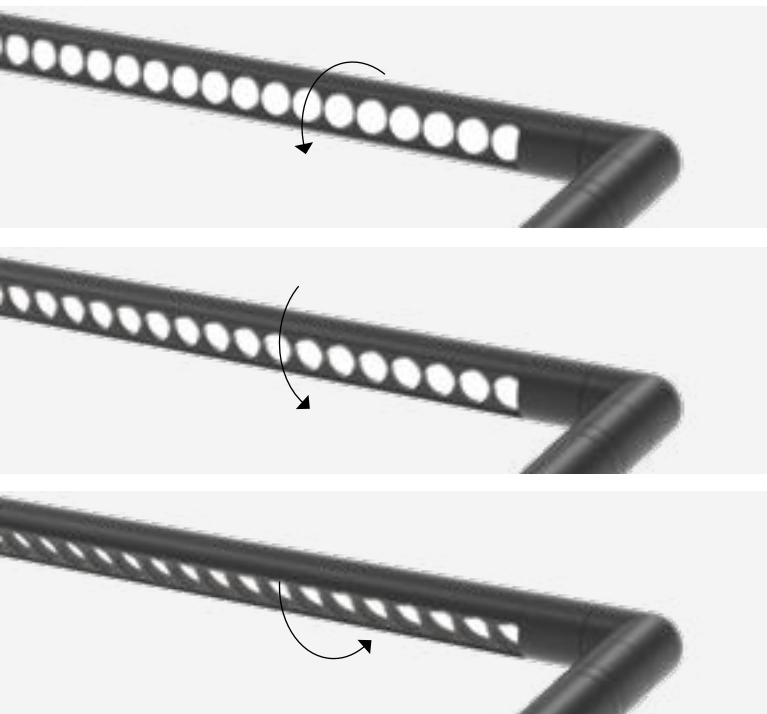

I moduli lineari consentono una **rotazione a 360° ad ogni estremità**, grazie ai cuscinetti radiali a sfere che garantiscono un **movimento fluido e controllato**, senza giochi o disallineamenti.

The linear modules allow a **360° rotation at each end**, enabled by radial ball bearings that ensure **smooth and controlled movement**, free from play or misalignment.



ESEMPI DI COMPOSIZIONI COMPOSITION EXAMPLES

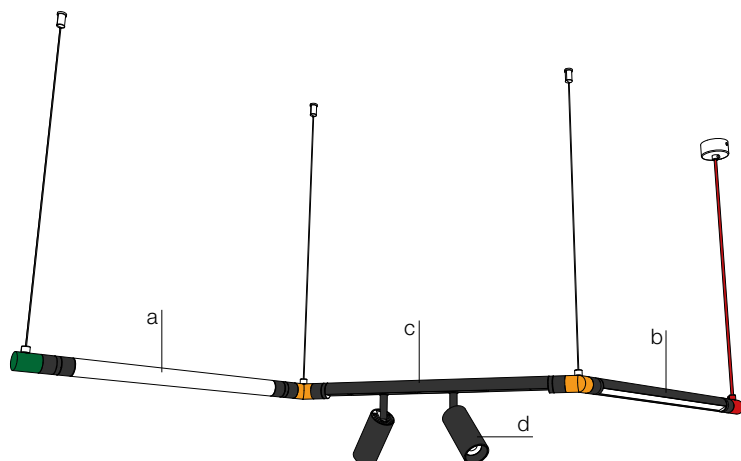

RIF.	CODICE	ARTICOLO	PZ
a.	115701.02	Modulo LED tutta luce 8W L 492 mm	1
b.	115704.02	Modulo LED microprismatico 14W L 492 mm	1
c.	115710.02	Modulo binario L 492 mm	1
d.	115713.02	Spot LED 7W	2
●	115720.02	Testata orizzontale non cablata	1
●	115721.02	Testata orizzontale cablata	1
●	115735.02	Giunto 120° 2 vie non cablato	2
	115751.02	Cavo di sospensione L 3000mm	3
	115752.02	Rosone per alimentatore remoto	1
	101369.99	Alimentatore 48V 75W	1

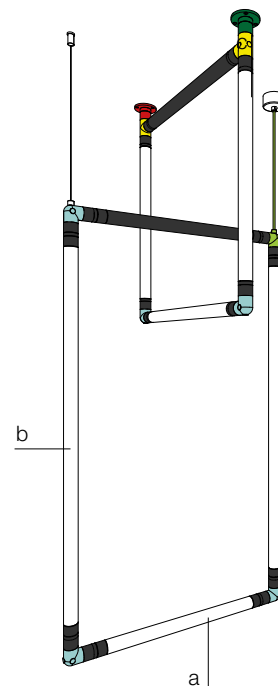

RIF.	CODICE	ARTICOLO	PZ
a.	115701.02	Modulo LED tutta luce 8W L 492 mm	4
b.	115702.02	Modulo LED tutta luce 15W L 924 mm	2
c.	115715.02	Modulo strutturale L 492 mm	2
●	115726.02	Testata soffitto per giunti non cablata	1
●	115727.02	Testata soffitto per giunti cablata	1
●	115732.02	Giunto 90° 2 vie non cablato	5
●	115734.02	Giunto 90° 2 vie cablato verticale	1
●	115738.02	Giunto 90° 3 vie non cablato	2
	115751.02	Cavo di sospensione L 3000mm	1
	115752.02	Rosone per alimentatore remoto	1
	101344.99	Alimentatore 48V 150W	1

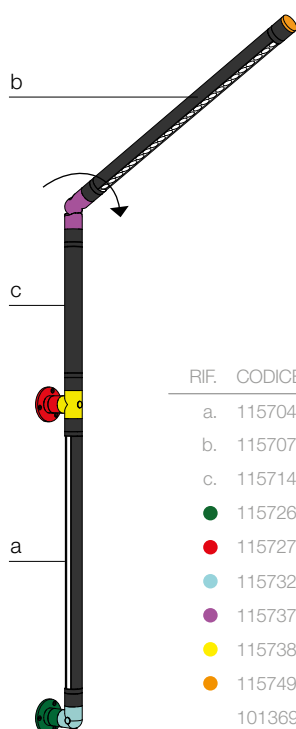

RIF.	CODICE	ARTICOLO	PZ
a.	115704.02	Modulo LED microprismatico 14W L 492 mm	1
b.	115707.02	Modulo LED micro ottiche 14W L 492 mm	1
c.	115714.02	Modulo strutturale L 276 mm	1
●	115726.02	Testata parete per giunti non cablata	1
●	115727.02	Testata parete per giunti cablata	1
●	115732.02	Giunto 90° 2 vie non cablato	1
●	115737.02	Giunto snodato 2 vie	1
●	115738.02	Giunto 90° 3 vie non cablato	1
●	115749.02	Tappi di chiusura	1
	101369.99	Alimentatore 48V 75W	1

Il giunto snodato The articulated joint

Consente la rotazione su un piano fino a 180°, con 21 posizioni ogni 9° e garantisce la stabilità dell'inclinazione, anche sotto carico.

It allows planar rotation up to 180°, with 21 positions at 9° increments and ensures the stability of the inclination, even under load.

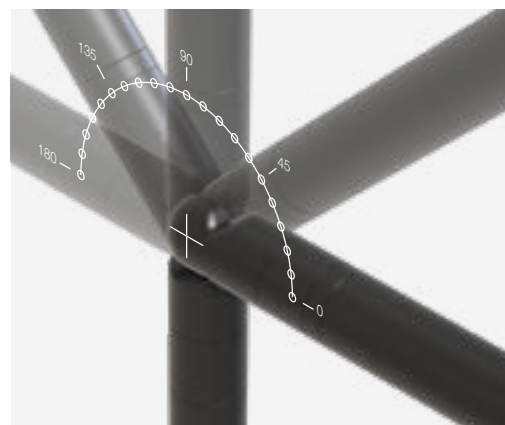

Molto più che un sistema di illuminazione... Much more than a lighting system..

Limitless è un sistema componibile che integra **luce e struttura**.
Una soluzione per creare strutture portanti in grado di sostenere un carico distribuito pari a 10 Kg su ciascun profilo, fino ad un massimo di 50 Kg sull'intera struttura. È possibile personalizzare le strutture integrandole con ripiani (non forniti, vedi istruzioni).

Limitless is a modular system that integrates **light and structure**.
A solution designed to create load-bearing structures capable of supporting a distributed load of 10 Kg per profile, up to a maximum of 50 Kg on the entire structure. The structures can be customized by integrating shelves (not supplied, see instructions).

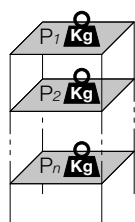

$P = \max 40 \text{ Kg}$

$P_{tot} = P_1 + P_2 + \dots + P_n = \max 50 \text{ Kg}$

$P = \text{carico applicabile sul ripiano}$
load applied to the shelf

RIF.	CODICE	ARTICOLO	PZ
a.	115704.02	Modulo LED microprismatico 14W L 492 mm	4
b.	115705.02	Modulo LED microprismatico 27W L 924 mm	4
c.	115714.02	Modulo strutturale L 276 mm	23
d.	115715.02	Modulo strutturale L 492 mm	13
e.	115716.02	Modulo strutturale L 924 mm	5
f.	115717.02	Modulo strutturale L 1464 mm	3
●	115724.02	Testata soffitto per moduli lineari non cablata	5
●	115725.02	Testata soffitto per moduli lineari cablata	1
●	115729.02	Testata terra per giunti	6
●	115732.02	Giunto 90° 2 vie non cablato	2
●	115742.02	Giunto 3D 3 vie non cablato	3
●	115746.02	Giunto 3D 4 vie non cablato	14
●	115748.02	Giunto 3D 5 vie non cablato	7
	101370.99	Alimentatore 48V 240W	1

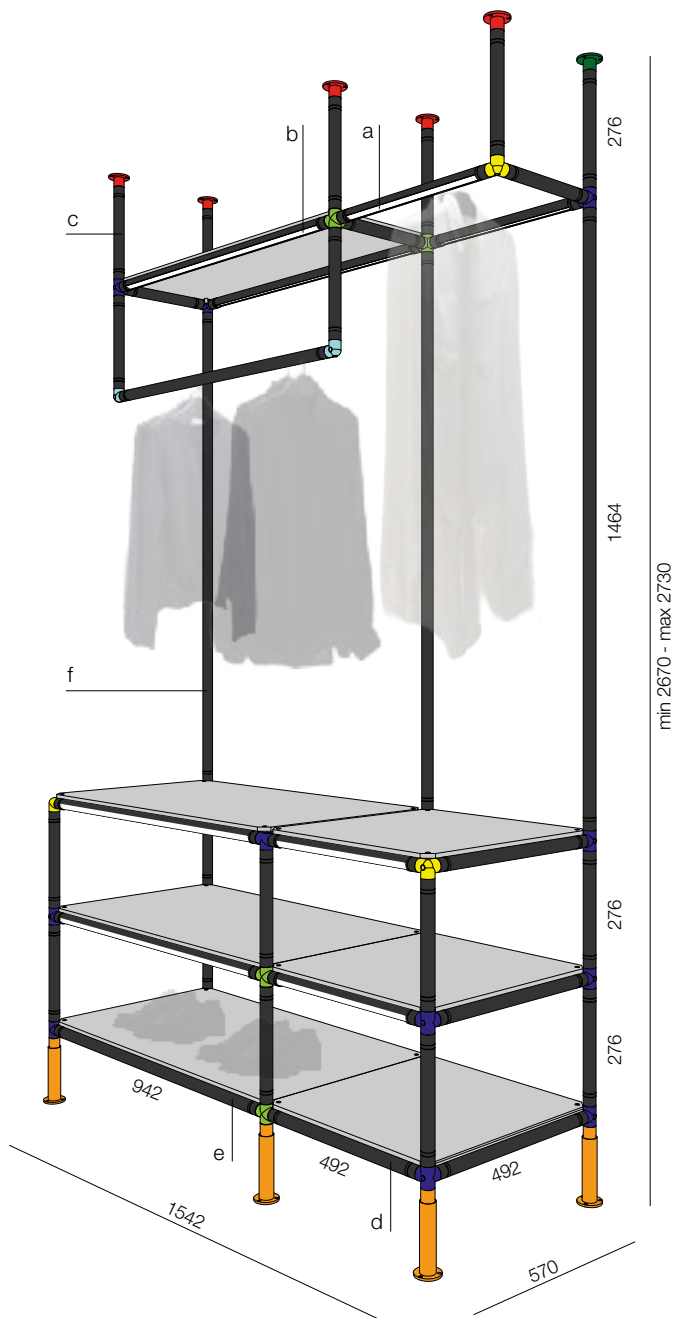

RIF.	CODICE	ARTICOLO	PZ
a.	115704.02	Modulo LED microprismatico 14W L 492 mm	2
b.	115705.02	Modulo LED microprismatico 27W L 924 mm	1
c.	115714.02	Modulo strutturale L 276 mm	4
●	115724.02	Testata soffitto per moduli lineari non cablata	3
●	115725.02	Testata soffitto per moduli lineari cablata	1
●	115732.02	Giunto 90° 2 vie non cablato	2
●	115742.02	Giunto 3D 3 vie non cablato	2
	101369.99	Alimentatore 48V 75W	1

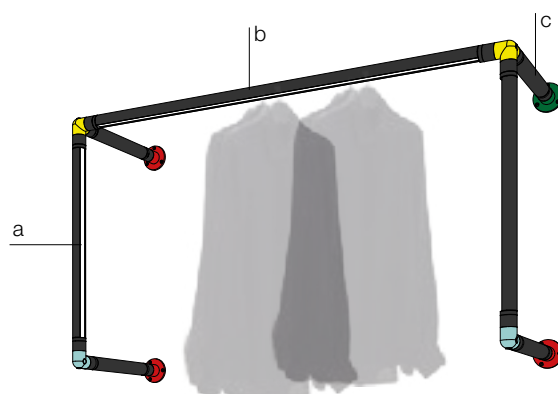

NEW

LIMITLESS



VIDEO

Sistema LED 48V per installazione a plafone, parete, sospensione, piantana e idoneo per la creazione di strutture portanti con moduli lineari luminosi e strutturali. I moduli lineari sono provvisti di connessioni elettrica e meccanica per testate e giunti, ad innesto ultra rapido con serraggio filettato, senza utilizzo di utensili e consentono una rotazione a 360° fluida, controllata e senza disallineamenti. Alimentazione 48V da remotizzare (ON/OFF o dimmerabile tramite interfacce di dimmerazione) o box con alimentazione integrata 48V ON/OFF o dimmerabile.

48V LED system designed for ceiling-mounted, wall-mounted, suspended and floor-standing installations, also suitable for the creation of load-bearing structures using luminous and structural linear modules. The linear modules are equipped with both electrical and mechanical connections at end caps and joints, featuring an ultra-fast plug-in system with threaded locking, tool-free assembly, and allowing for smooth, controlled 360° rotation without misalignment. The system operates at 48V power supply, available with remote power units (ON/OFF or dimmable via dimming interfaces) or with an integrated 48V ON/OFF or dimmable power supply housed in a box.

◆ Carico massimo di alimentazione 240W / Maximum power input 240W

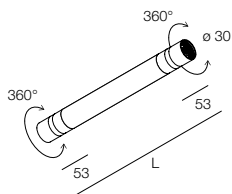
MODULI LINEARI
LINEAR MODULES

MODULO LED TUTTA LUCE
Profilo esterno composto da diffusore opale a 360° ad elevata resistenza meccanica e da anima interna in silicone diffondente.

FULL LIGHT LED MODULE
External profile featuring a 360° opal diffuser with high mechanical resistance, combined with an internal diffusing silicone core.

■	L (mm)		3000K
115701.02	492	8W	553 lm
115702.02	924	15W	1106 lm
115703.02	1464	25W	1797 lm

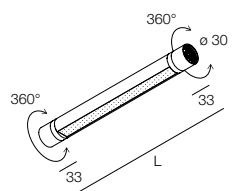

MODULO LED MICROPRISMATICO
Profilo in lega di alluminio verniciato a polvere nera, completo di diffusore microprismatico.

MICROPRISMATIC LED MODULE
Powder-coated black aluminium alloy profile, complete with microprismatic diffuser.

■	L (mm)		3000K
115704.02	492	14W	794 lm
115705.02	924	27W	1588 lm
115706.02	1464	44W	2580 lm

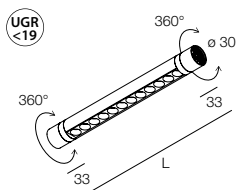

MODULO LED MICROOTTICHE
Profilo in lega di alluminio verniciato a polvere nera, completo di micro-ottiche e lenti in PC per emissione controllata UGR<19.

MICRO-OPTIC LED MODULE
Powder-coated black aluminium alloy profile, fitted with micro-optics and PC lenses for controlled light emission UGR<19.

■	L (mm)		3000K
115707.02	492	14W	1047 lm
115708.02	924	27W	2095 lm
115709.02	1464	44W	3404 lm

MODULO BINARIO
TRACK MODULE

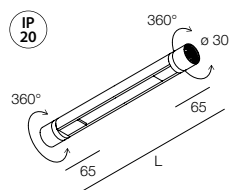

MODULO BINARIO

Profilo in lega di alluminio verniciato a polvere nera, completo di binario magnetico a due conduttori a bassa tensione 48V. Idoneo per spot LED orientabili e liberamente spostabili lungo il binario.

TRACK MODULE

Powder-coated black aluminium alloy profile, complete with 48V low-voltage two-conductor magnetic track. Suitable for adjustable LED spotlights, freely positionable along the track.

■	L (mm)
115710.02	492
115711.02	924
115712.02	1464

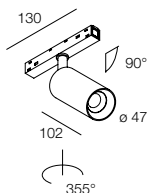

SPOT LED

Proiettore orientabile, completo di adattatore magnetico a serraggio meccanico per installazione sul modulo binario. Lente in policarbonato, corpo e riflettore in lega di alluminio verniciato a polvere nera.

LED SPOTLIGHT

Adjustable spotlight, complete with magnetic adapter with mechanical locking for installation on the track module. Polycarbonate lens, with powder-coated black aluminium alloy body and reflector.

■		3000K	
115713.02	7W	690 lm	42°

MODULO STRUTTURALE
STRUCTURAL MODULE

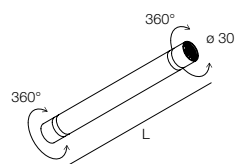

MODULO STRUTTURALE

Profilo in lega di alluminio verniciato a polvere nera.

STRUCTURAL MODULE

Powder-coated black aluminium alloy profile.

■	L (mm)
115714.02	276
115715.02	492
115716.02	924
115717.02	1464

TESTATA VERTICALE
VERTICAL HEAD



NON CABLATA / UNWIRED
Cavo di sospensione non incluso
Suspension cable not included

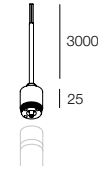
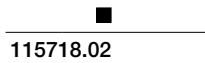

CABLATA / WIRED
Cavo / cable 2x0,75 mm²

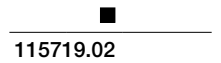

TESTATA ORIZZONTALE
HORIZONTAL HEAD



NON CABLATA / UNWIRED
Cavo di sospensione non incluso
Suspension cable not included

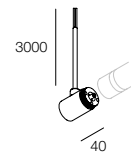
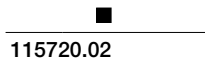

CABLATA / WIRED
Cavo / cable 2x0,75 mm²

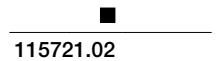

TESTATA ORIZZONTALE DECO
DECO HORIZONTAL HEAD

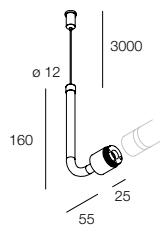

NON CABLATA / UNWIRED
Cavo di sospensione incluso
Suspension cable included

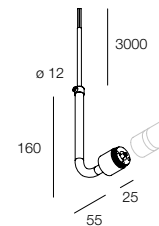
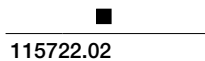

CABLATA / WIRED
Cavo / cable 2x0,75 mm²

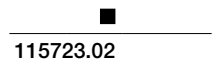

TESTATA SOFFITTO / PARETE / TERRA
Per moduli lineari
CEILING / WALL / FLOOR HEAD
For linear modules



NON CABLATA / UNWIRED

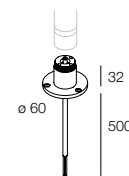

CABLATA / WIRED
Cavo / cable 2x0,75 mm²



TESTATA SOFFITTO / PARETE / TERRA
Per giunti
CEILING / WALL / FLOOR HEAD
For joints

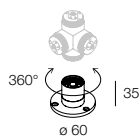

NON CABLATA / UNWIRED

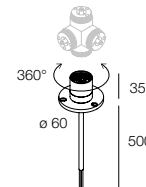

CABLATA / WIRED
Cavo / cable 2x0,75 mm²



TESTATA REGOLABILE
SOFFITTO / PARETE / TERRA
Per moduli lineari
ADJUSTABLE HEAD
CEILING / WALL / FLOOR
For linear modules

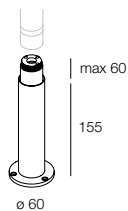

NON CABLATA / UNWIRED

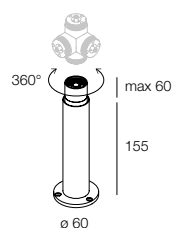
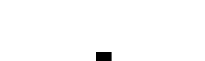

NON CABLATA / UNWIRED

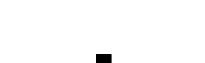

TESTATA REGOLABILE
SOFFITTO / PARETE / TERRA
Per giunti
ADJUSTABLE HEAD
CEILING / WALL / FLOOR
For joints

GIUNTO LINEARE 2 VIE
2-WAY LINEAR JOINT

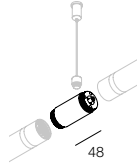

NON CABLATO / UNWIRED
Sospensibile. Cavo di sospensione opzionale non incluso.
Suspendible. Optional suspension cable not included.

115730.02

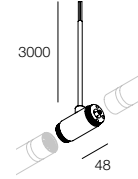

CABLATO / WIRED
Cavo / cable 2x0,75 mm²

115731.02

GIUNTO 90° 2 VIE
2-WAY 90° JOINT

NON CABLATO / UNWIRED
Sospensibile in orizzontale o verticale. Cavo di sospensione opzionale non incluso.
Suspendible in horizontal or vertical. Optional suspension cable not included.

115732.02

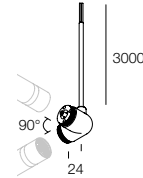

CABLATO - ORIZZONTALE
WIRED - HORIZONTAL
Cavo / cable 2x0,75 mm²

115733.02

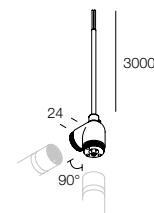
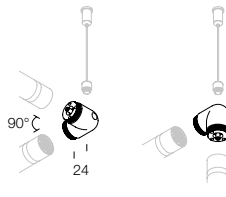

CABLATO - VERTICALE
WIRED - VERTICAL
Cavo / cable 2x0,75 mm²

115734.02 Euro | CHF 46,25

GIUNTO 120° 2 VIE
2-WAY 120° JOINT



NON CABLATO / UNWIRED
Sospensibile. Cavo di sospensione opzionale non incluso.
Suspendible. Optional suspension cable not included.

115735.02

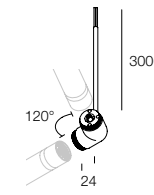

CABLATO / WIRED
Cavo / cable 2x0,75 mm²

115736.02

GIUNTO SNODATO 2 VIE
2-WAY ARTICULATED JOINT

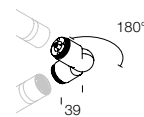

NON CABLATO / UNWIRED

115737.02

GIUNTO 90° 3 VIE
3-WAY 90° JOINT

NON CABLATO / UNWIRED
Sospensibile in orizzontale o verticale. Cavo di sospensione opzionale non incluso.
Suspendible in horizontal or vertical. Optional suspension cable not included.

115738.02

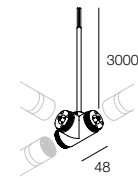

CABLATO / WIRED
Cavo / cable 2x0,75 mm²

115739.02

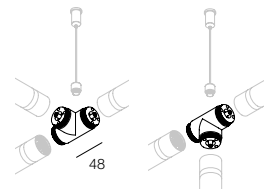

GIUNTO 120° 3 VIE
3-WAY 120° JOINT

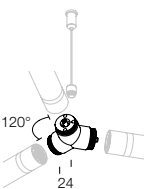

NON CABLATO / UNWIRED
Sospensibile. Cavo di sospensione opzionale non incluso.
Suspendible. Optional suspension cable not included.

115740.02

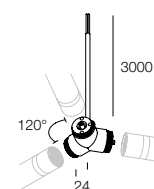

CABLATO / WIRED
Cavo / cable 2x0,75 mm²

115741.02

GIUNTO 3D 3 VIE
3-WAY 3D JOINT



NON CABLATO / UNWIRED
Sospendibile. Cavo di sospensione
opzionale non incluso.
Suspendible. Optional suspension
cable not included.

115742.02

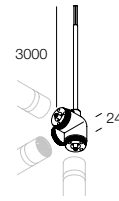

CABLATO / WIRED
Cavo / cable 2x0,75 mm²

115743.02

GIUNTO X 4 VIE
4-WAY X JOINT



NON CABLATO / UNWIRED
Sospendibile. Cavo di sospensione
opzionale non incluso.
Suspendible. Optional suspension
cable not included.

115744.02

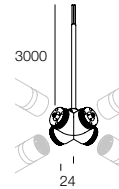

CABLATO / WIRED
Cavo / cable 2x0,75 mm²

115745.02

GIUNTO 3D 4 VIE
4-WAY 3D JOINT



NON CABLATO / UNWIRED
Sospendibile. Cavo di sospensione
opzionale non incluso.
Suspendible. Optional suspension
cable not included.

115746.02

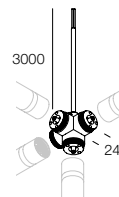

CABLATO / WIRED
Cavo / cable 2x0,75 mm²

115747.02

GIUNTO 3D 5 VIE
5-WAY 3D JOINT

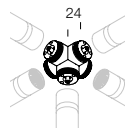

NON CABLATO / UNWIRED

115748.02

LIMITLESS

ACCESSORI
ACCESSORIES



TAPPI DI CHIUSURA (2 pz)

END CAPS (2 pcs)

115749.02



FISSAGGIO SOFFITTO O PARETE
Da installare con interasse massimo
di 2m.

CEILING OR WALL FIXING
Installation spacing: max 2 m.

115750.02

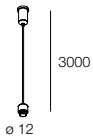

CAVO DI SOSPENSIONE (1 pz)
Con guaina nera. Da installare con
interasse massimo di 2m. Carico
massimo 5 kg.

SUSPENSION CABLE (1 pc)
Black-sheathed. Installation
spacing: max 2 m.
Maximum load: 5 kg

Module	L (mm)	Kg
115751.02	3000	

Module	Kg
276 mm	0,3
492 mm	0,5
924 mm	0,8
1464 mm	1,2
Spot	0,2



ROSONE
Per alimentatore remoto

CANOPY
For remote driver

115752.02

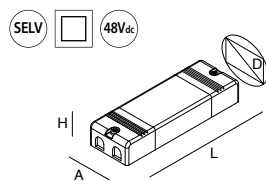

ALIMENTATORE ELETTRONICO
STABILIZZATO 48V 220-240V 50/60 Hz
Per dimmerazione prevedere interfacce
48V (vedi sezione Gestione luce)

ELECTRONIC STABILIZED DRIVER 48V
220-240V 50/60 Hz
For dimming, provide 48V interfaces (see
Light Management section)

		A (mm)	D (mm)	H (mm)	L (mm)
101369.99	75W	38	49	30	168
101344.99	150W	38	49	30	227
101370.99	250W	78	55	35	215

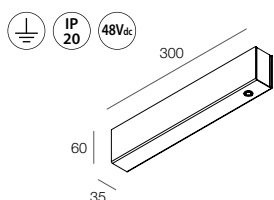

BOX CON ALIMENTAZIONE INTEGRATA
100W 48V 220-240V 50/60Hz
Per composizioni a sospensione

BOX WITH INTEGRATED DRIVER
100W 48V 220-240V 50/60Hz
For suspended compositions

115753.02	100W
------------------	------

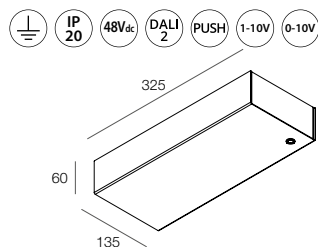

BOX CON ALIMENTAZIONE INTEGRATA
250W 48V 220-240V 50/60Hz
Per composizioni a sospensione

BOX WITH INTEGRATED DRIVER
250W 48V 220-240V 50/60Hz
For suspended compositions

115754.02	250W
------------------	------

DALI - PUSH - 0-10V - 1-10V

115755.02	150W
------------------	------

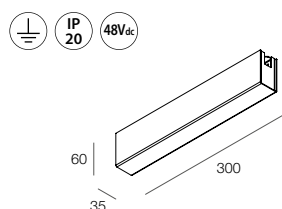

BOX CON ALIMENTAZIONE INTEGRATA
100W 48V 220-240V 50/60Hz
Per composizioni a plafone

BOX WITH INTEGRATED DRIVER
100W 48V 220-240V 50/60Hz
For ceiling-mounted compositions

115757.02	100W
------------------	------

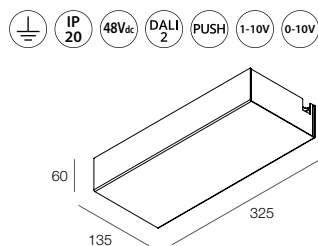

BOX CON ALIMENTAZIONE INTEGRATA
250W 48V 220-240V 50/60Hz
Per composizioni a plafone

BOX WITH INTEGRATED DRIVER
250W 48V 220-240V 50/60Hz
For ceiling-mounted compositions

115758.02	250W
------------------	------

DALI - PUSH - 0-10V - 1-10V

115759.02	150W
------------------	------

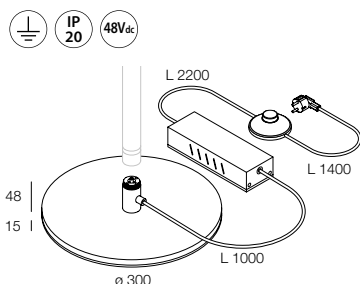

KIT ALIMENTAZIONE DA TERRA
Per piantana.
Completo di testata per moduli
lineari, alimentatore ON-OFF 100W,
interruttore e spina CEE 7/4 tipo
schuko.

FLOOR POWER SUPPLY KIT
For floor lamp.
Complete with head for linear
modules, 100W ON-OFF power
supply, switch, and CEE 7/4 type
Schuko plug.

115756.02	100W
------------------	------