

GIADA SYSTEM

Interfacce di controllo per comandi vocali
Control interfaces for voice commands



Sistema di domotica lighting in wireless IOT per regolare, comandare e gestire qualsiasi fonte di luce da un dispositivo remoto. E' possibile interfacciare GIADA SYSTEM con Alexa o Google Home per sfruttare il controllo vocale dei dispositivi.

IOT wireless home automation lighting system to adjust, control and manage any light source from a remote device. You can interface GIADA SYSTEM with Alexa or Google Home to take advantage of the device voice control.

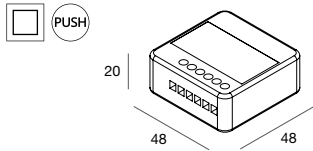

INTERFACCIA PUSH DALI
1 canale DALI
Gestibili max 30 alimentatori DALI in broadcast.
Controllo tramite App o pulsante.

105934.99

PUSH DALI INTERFACE
1 DALI channel
Manages up to 30 DALI drivers in broadcast mode.
Control via App or push button.

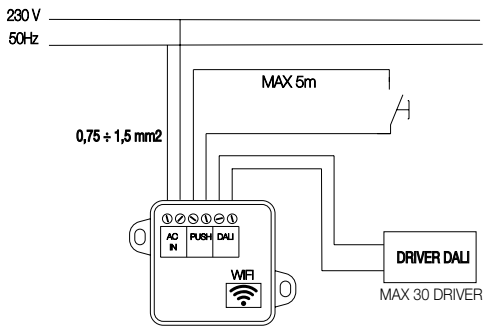

MODULI PER FARETTI MODULES FOR DOWNLIGHTS

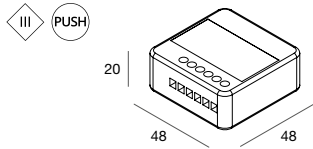

MODULO DIMMERABILE PER APPARECCHI A 350mA
1 canale, in corrente costante.
Controllo mediante app o pulsante.

105920.99

DIMMABLE MODULE FOR 350mA FIXTURES
1 channel, at constant current.
Control by app or button.

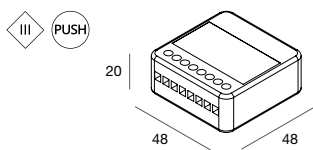

MODULO DIMMERABILE PER APPARECCHI A 350mA
2 canali, in corrente costante.
Controllo mediante app o pulsante.

105921.99

DIMMABLE MODULE FOR 350mA FIXTURES
2 channels, at constant current.
Control by app or button.

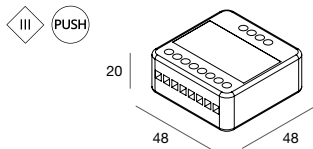

MODULO DIMMERABILE PER APPARECCHI A 500mA
1 canale, in corrente costante.
Controllo mediante app o pulsante.

105922.99

DIMMABLE MODULE FOR 500mA FIXTURES
1 channel, at constant current.
Control by app or button.

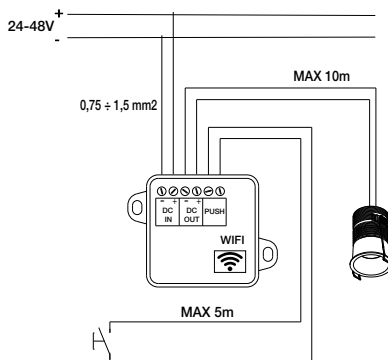

IMPIEGHI SINGOLI MODULI GIADA SYSTEM PER FARETTI
SINGLE USE GIADA SYSTEM MODULES FOR SPOTLIGHTS

	KONE				WELL		MINI WELL		SLIM		NEW STEP						
	5W		7W		10W		18W		10W		9W		13W		2W		
	24V	48V	24V	48V	24V	48V	24V	48V	24V	48V	24V	48V	24V	48V	24V	48V	
105920.99			1	2									1		1		
105921.99			2	4								2		2			
105922.99	2	4			1	2		1	1	2	2	4				6	12

MODULI PER STRIP LED
MODULES FOR LED STRIPS

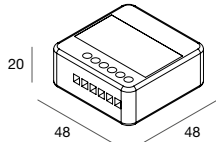

MODULO DIMMERABILE PER STRIP LED BIANCHE

max 6A
1 canale, in tensione costante.
Controllo mediante app o pulsante.

105917.99

DIMMABLE MODULE FOR WHITE LED STRIP

max 6A
1 channel, at constant voltage.
Control by app or button.

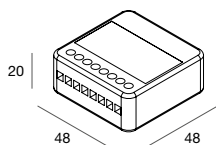

MODULO DIMMERABILE PER STRIP LED TUNABLE WHITE

max 6A totali
2 canali, in tensione costante.
Controllo mediante app o pulsante.

105918.99

DIMMABLE MODULE FOR TUNABLE WHITE LED STRIP

max 6A total
2 channels, at constant voltage.
Control by app or button.

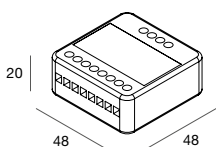

MODULO DIMMERABILE PER STRIP LED RGB

max 6A totali
3 canali, in tensione costante.
Controllo mediante app o pulsante.

105919.99

DIMMABLE MODULE FOR RGB STRIP LED

max 6A total
3 channels, at constant voltage.
Control by app or button.

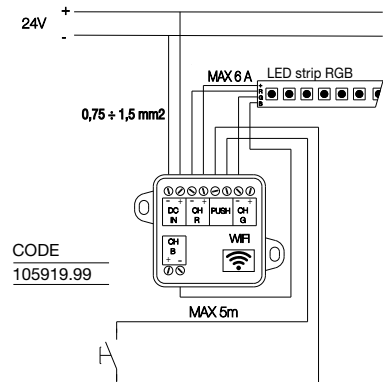
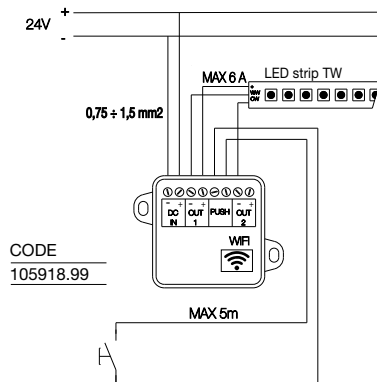
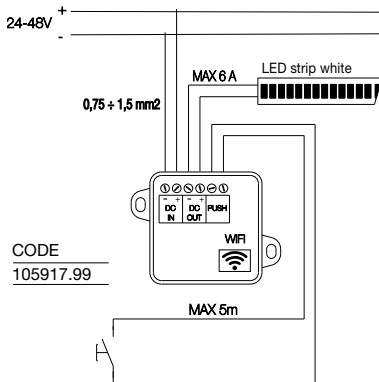

IMPIEGHI SINGOLI MODULI GIADA SYSTEM PER STRIP LED
SINGLE USE GIADA SYSTEM MODULES FOR LED STRIP

	WHITE		TW	RGB
	24V	48V	24V	24V
105917.99	144W	288W		
105918.99			144W	
105919.99				144W

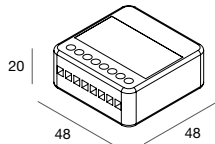

MODULO DIMMERABILE TAGLIO DI FASE MAX 200W

1 canale, a tensione di rete.
Controllo mediante app o pulsante

105916.99

PHASE CUT DIMMABLE MODULE MAX 200W

1 channel, at mains voltage.
Control by app or button.

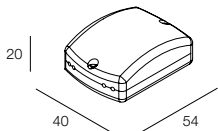
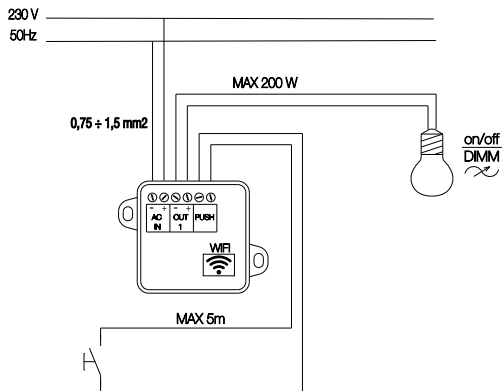

MODULO ACCENSIONE/SPEGNIMENTO GRUPPI

Dispositivo Wifi per il controllo ON/OFF di max 2 gruppi di moduli Giada System tramite 2 pulsanti NA.
Controllo dimmerazione solo tramite App.

105935.99

GROUP ON/OFF MODULE

Wi-Fi device for ON/OFF control of up to 2 groups of Giada System modules via 2 NO push buttons.
Dimming control available only via App.

