



Experience
Light

DOMYNOS PS



DOMYNOS PS

DOMYNOS PS crea un dialogo delicato con lo spazio che illumina. Uno speciale sistema di illuminazione Novalux con cui, combinando pochi moduli base, si aprono infinite possibilità di composizioni modulari, curvilinee o lineari. Disponibile nelle finiture in vernice bianca, nera, caffè o cappuccino. DOMYNOS PS è un prodotto di illuminazione Novalux che si contraddistingue per leggerezza ed eleganza: la sinuosità delle sue curve abbraccia con raffinatezza grandi e piccoli ambienti, rendendoli unici.

DOMYNOS PS creates a delicate dialogue with the space it illuminates. A special Novalux lighting system with which, combining a few basic modules, open up endless possibilities of modular, curvilinear or linear compositions. Available in white, black, coffee or cappuccino finishes. DOMYNOS PS is a Novalux lighting product that stands out for its lightness and elegance: the sinuosity of its curves embraces with refinement large and small environments, making them unique.

DOMYNOS PS

LA LUCE CHE
DISEGNA EMOZIONI.

LIGHT THAT
SHAPE EMOTIONS.

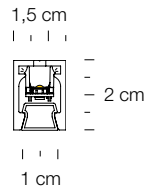

Opzione con **alimentazione integrata** nel driver box.
Option with **power supply integrated** into the driver box.



112225._ _

Kit connessione **inizio linea** per installazione a **plafone e parete**.

Line start connection kit for **ceiling and wall** installation.

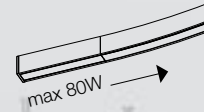

112227._ _

Kit connessione **inizio linea** per installazione a **sospensione**.

Line start connection kit for **suspended** installation.

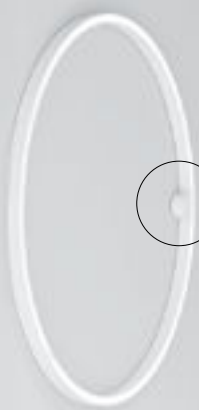
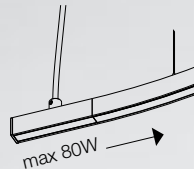

112226._ _

Kit connessione **inizio linea o centrale** per installazione a **plafone e parete**.

Line start or middle line connection kit for **ceiling and wall** installation.





VIDEO

Il profilo con fresatura asimmetrica garantisce la **totale tenuta della luce** nei punti di giunzione.

The asymmetrically milled profile ensures **complete light tightness** at the joints.

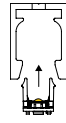

Basi LED con **connettore rapido** e clip a scatto per fissaggio sul profilo.

LED bases with **quick connector** and snap-in clips for profile mounting.



Schermo flessibile da 6m, tagliabile, che si adatta al profilo minimizzando le interruzioni.

Flexible 6-meter diffuser, cuttable, that adapts to the profile while minimizing interruptions.

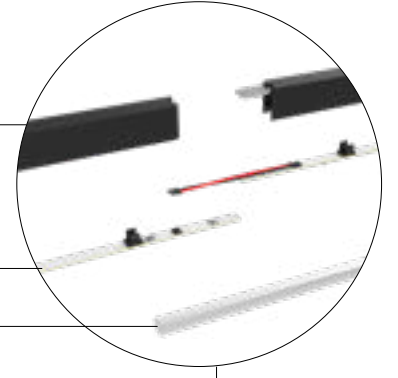

SYSTEMS

Opzione con alimentazione remota + rosone.

Option with remote power supply + canopy.



112228._ _

Kit connessione **inizio linea o centrale** per installazione a **sospensione**.

Line start or middle line connection kit for **suspended** installation.

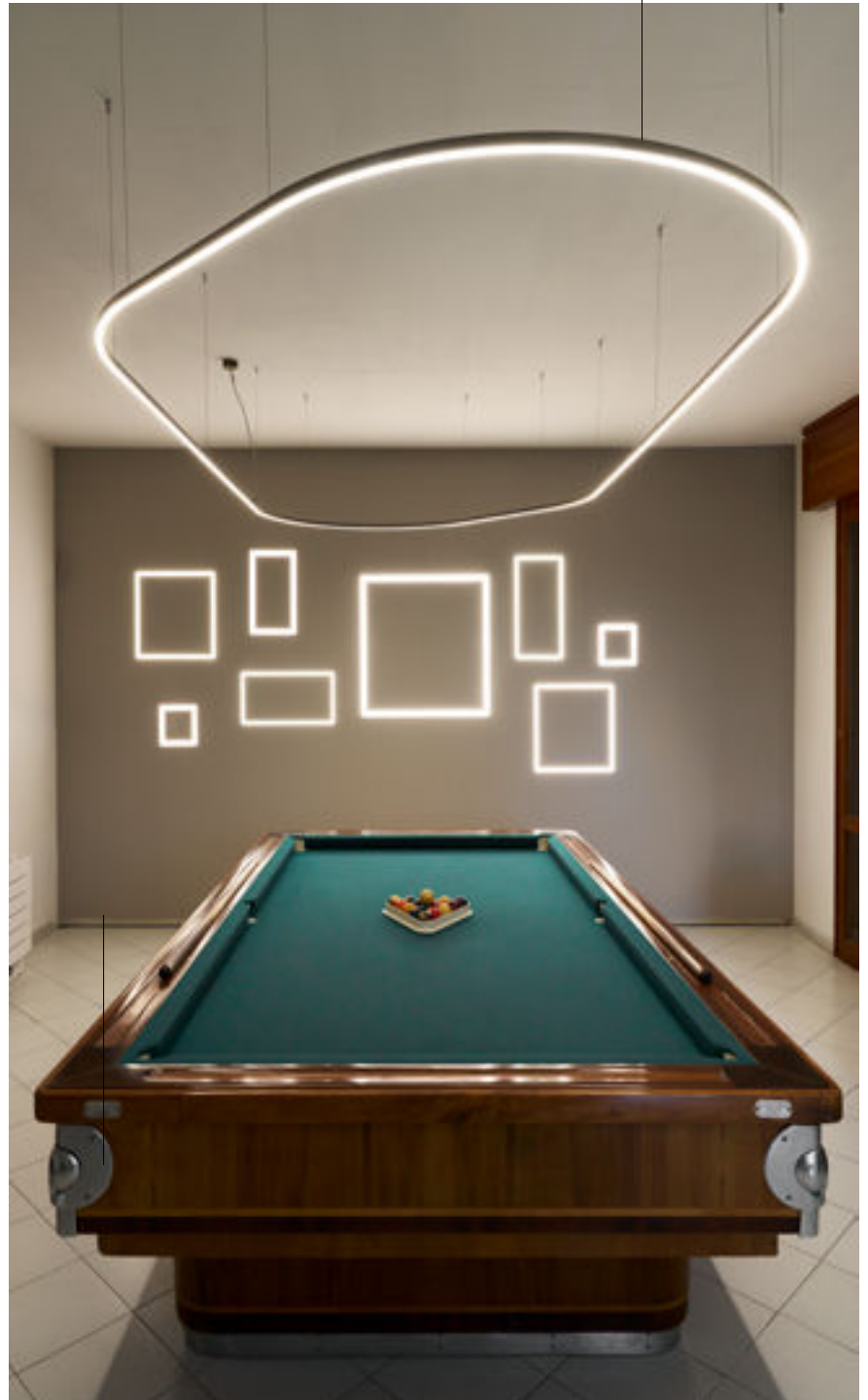
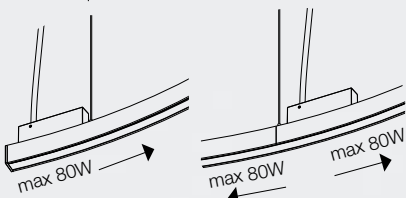

DOMYNOS PS



Sistema componibile a plafone, parete o sospensione con profilo in estruso di alluminio per l'alloggiamento di moduli LED 48V. Kit di giunzione incluso e schermo opale da ordinare a parte per profili lineari e curvi. Alimentazione 48V da remotizzare (ON/OFF o dimmerabile tramite interfacce di dimmerazione) o box con alimentazione integrata 48V ON/OFF o dimmerabile, per composizioni a sospensione.

Modular ceiling, wall or suspension system with extruded aluminium profile for housing 48V LED modules. Junction kit included and opal diffuser shade to be ordered separately. Remote 48V driver (ON/OFF or dimmable via dimming interfaces) or box with integrated driver 48V, ON/OFF or dimmable, for suspended compositions.

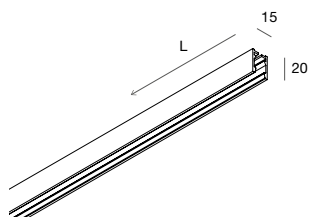
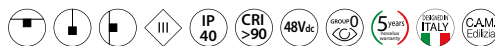

PROFILO LINEARE

Per moduli LED lineari L=498mm.

LINEAR PROFILE

For linear LED modules L=498mm.

	□	■	■	■	L (mm)	n° LED modules
112201._	01	02	20	21	498	1
112202._	01	02	20	21	996	2
112203._	01	02	20	21	1992	4

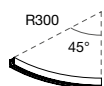

PROFILO CURVO R300 45°

Per modulo LED R300 45°.

Non installabile a sospensione stand alone.

CURVED R300 45° PROFILE

For LED modules R300 45°.

Not installable in stand alone suspension.

	□	■	■	■	L (mm)	R (mm)	n° LED modules
112204._	01	02	20	21	249	300	1

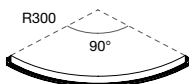

PROFILO CURVO R300 90°

Per modulo LED R300 90°.

Non installabile a sospensione stand alone.

CURVED R300 90° PROFILE

For LED modules R300 90°.

Not installable in stand alone suspension.

	□	■	■	■	L (mm)	R (mm)	n° LED modules
112205._	01	02	20	21	498	300	1

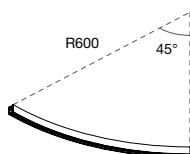

PROFILO CURVO R600 45°

Per modulo LED R600 45°.

Non installabile a sospensione stand alone.

CURVED R600 45° PROFILE

For LED modules R600 45°.

Not installable in stand alone suspension.

	□	■	■	■	L (mm)	R (mm)	n° LED modules
112206._	01	02	20	21	498	600	1

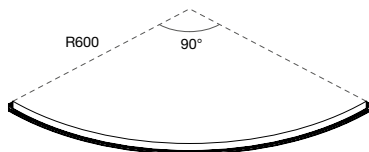

PROFILO CURVO R600 90°

Per modulo LED R600 90°.

CURVED R600 90° PROFILE

For LED modules R600 90°.

	□	■	■	■	L (mm)	R (mm)	n° LED modules
112207._	01	02	20	21	996	600	1

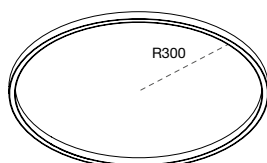

PROFILO CIRCOLARE R300

Per 4 moduli LED R300 90°.

Schermo opale incluso.

CIRCULAR R300 PROFILE

For 4 LED modules R300 90°.

Opal diffuser shade included.

	□	■	■	■	L (mm)	R (mm)	n° LED modules
112208._	01	02	20	21	1992	300	4

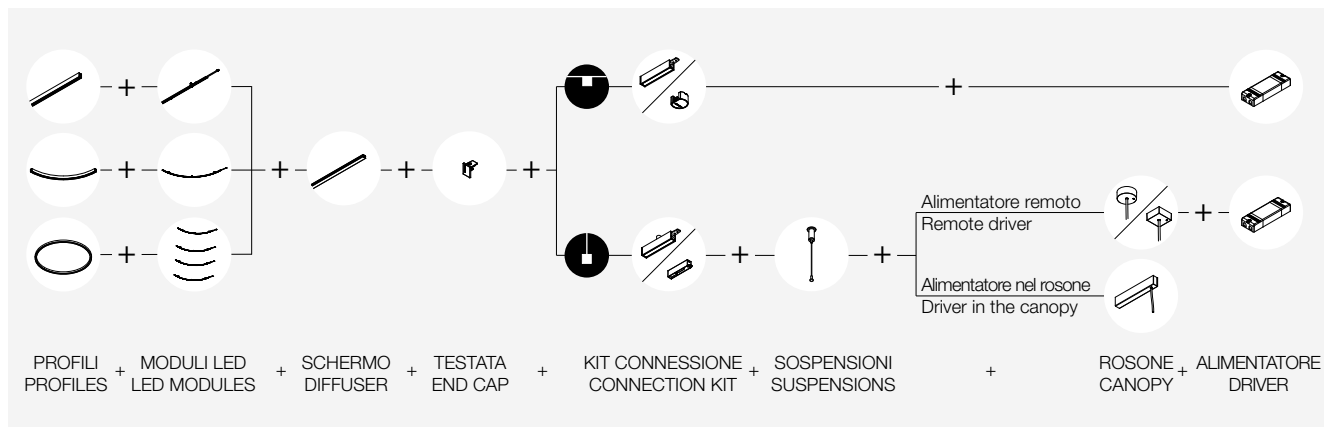

MODULI LED LED MODULES

Moduli LED alimentabili a 48V provvisti di connettori in testa e coda per la connessione rapida in linea continua ed agganci plastici per il montaggio sul profilo.

48V LED modules equipped with connectors on both sides for fast continuous line connection and plastic hooks for mounting on the profile.

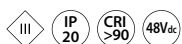

◆ Potenza massima in linea continua 80W (6m) / Maximum power in continuous line 80W (6m)

MODULO LED LINEARE

LINEAR LED MODULE

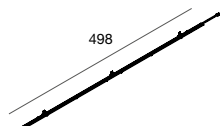

					L (mm)
112209.99	2700K	6,6W	861 lm		498
112210.99	3000K	6,6W	915 lm		498
112211.99	4000K	6,6W	978 lm		498

MODULO LED R300 45°

LED MODULE R300 45°

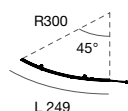

					L (mm)
112212.99	2700K	3,3 W	435 lm		249
112213.99	3000K	3,3 W	462 lm		249
112214.99	4000K	3,3 W	493 lm		249

MODULO LED R300 90°

LED MODULE R300 90°

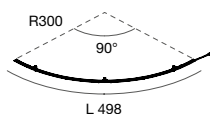

					L (mm)
112215.99	2700K	6,6 W	856 lm		498
112216.99	3000K	6,6 W	910 lm		498
112217.99	4000K	6,6 W	971 lm		498

MODULO LED R600 45°

LED MODULE R600 45°

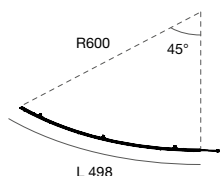

					L (mm)
112218.99	2700K	6,6 W	862 lm		498
112219.99	3000K	6,6 W	916 lm		498
112220.99	4000K	6,6 W	980 lm		498

MODULO LED R600 90°

LED MODULE R600 90°

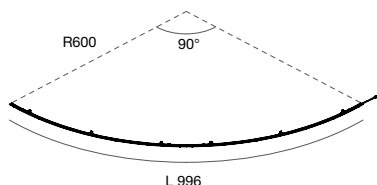

					L (mm)
112221.99	2700K	13,2 W	1724 lm		996
112222.99	3000K	13,2 W	1832 lm		996
112223.99	4000K	13,2 W	1960 lm		996

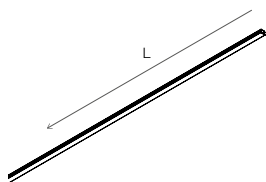

SCHERMO OPALE 6m
Schermo curvabile e tagliabile in opera

L (mm)
110825.99 6000 Opale / Opal

OPAL DIFFUSER SHADE 6m
Bendable diffuser shade,
can be cut on site.



TESTATA TERMINALE (1 pz)
Da prevedere a inizio e fine linea
continua.

112224. __ 01 02 20 21

END CAP (1 pc)
To be provided at the beginning
and end of continuous line.

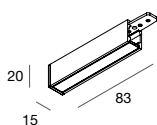

KIT CONNESSIONE INIZIO LINEA PER
INSTALLAZIONE A PLAFONE E PARETE
Completo di testata terminale e cavetti
per la connessione elettrica tra LED
ed alimentazione 48V. Non idoneo per
composizioni chiuse. Alimentazione 48V
da ordinare a parte.

112225. __ 01 02 20 21

LINE START CONNECTION KIT FOR
CEILING AND WALL INSTALLATION
Complete with end cap and cables for
the electrical connection between LED
and 48V driver. Not suitable for closed
compositions. 48V driver to be ordered
separately.

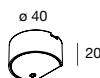
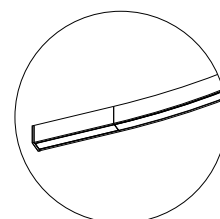

KIT CONNESSIONE INIZIO LINEA
O CENTRALE PER INSTALLAZIONE A
PLAFONE E PARETE
Completo di cavetti per la connessione
elettrica tra LED ed alimentazione 48V.
Alimentazione 48V da ordinare a parte.

112226. __ 01 02 20 21

LINE START OR MIDDLE LINE
CONNECTION KIT FOR CEILING
AND WALL INSTALLATION
Complete with cables for the electrical
connection between LED and 48V
driver. 48V driver to be ordered
separately.

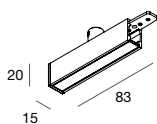
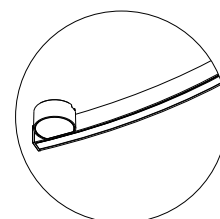
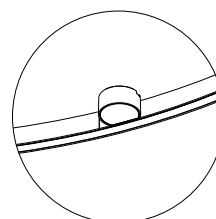

KIT CONNESSIONE INIZIO LINEA
PER INSTALLAZIONE
A SOSPENSIONE
Completo di testata terminale e cavetti
per la connessione elettrica tra LED
ed alimentazione 48V. Non idoneo
per composizioni chiuse. Driver box o
rosone ed alimentatore 48V da ordinare
a parte.

112227. __ 01 02 20 21

LINE START CONNECTION KIT
FOR SUSPENDED INSTALLATION
Complete with end cap and cables for
the electrical connection between LED
and 48V driver. Not suitable for closed
compositions. Driver box or canopy and
48V driver to be ordered separately.

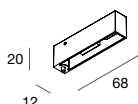
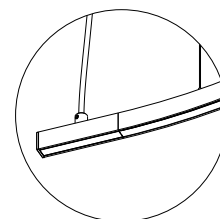

KIT CONNESSIONE INIZIO LINEA
O CENTRALE PER INSTALLAZIONE
A SOSPENSIONE
Completo di cavetti per la
connessione elettrica tra LED ed
alimentazione 48V. Driver box o
rosone ed alimentatore 48V da
ordinare a parte.

112228. __ 01 02 20 21

LINE START OR MIDDLE LINE
CONNECTION KIT
FOR SUSPENDED INSTALLATION
Complete with cables for the electrical
connection between LED and 48V
driver. Driver box or canopy and 48V
driver to be ordered separately.

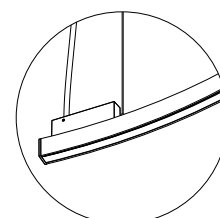
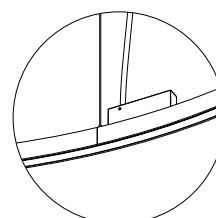

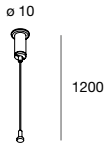

CAVO DI SOSPENSIONE (1pz)
In acciaio, regolabile.
1 pz a inizio e fine linea continua e in ciascuna giunzione tra profili. 1pz aggiuntivo per fissaggio centrale dei profili cod. 112203._ _ e 112207._ _.
3 pz per il profilo 112208._ _.

	L (mm)
112229.99	1200

SUSPENSION CABLE (1pc)
Made of steel, adjustable. 1 pc at the beginning and end of continuous line and in each junction between profiles. 1pc more in the middle of profiles 112203._ _ and 112207._ _.
3 pcs for profile 112208._ _.

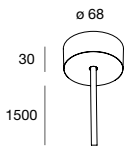

ROSONE TONDO
ALIMENTAZIONE REMOTA
Rosone a plafone. Cavo 2x1mm² con guaina in tinta per bianco e nero e trasparente per caffè e cappuccino. Alimentazione 48V da ordinare a parte.

	□	■	■	■	L (mm)
109003._ _	01	02	20	21	1500

ROUND CANOPY
REMOTE DRIVER
Ceiling canopy. Cable 2x1mm² with matching sheath for black and white and transparent for caffè and cappuccino. 48V driver to be ordered separately.

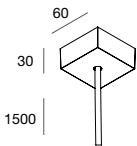

ROSONE QUADRATO
ALIMENTAZIONE REMOTA
Rosone a plafone. Cavo 2x1mm² con guaina in tinta per bianco e nero e trasparente per caffè e cappuccino. Alimentazione 48V da ordinare a parte.

	□	■	■	■	L (mm)
109004._ _	01	02	20	21	1500

SQUARE CANOPY
REMOTE DRIVER
Ceiling canopy. Cable 2x1mm² with matching sheath for black and white and transparent for caffè and cappuccino. 48V driver to be ordered separately.

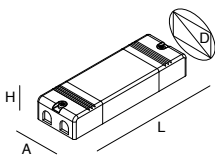
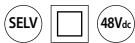

ALIMENTATORE ELETTRONICO
STABILIZZATO 48V 220-240V 50/60 Hz
Per dimmerazione prevedere interfacce 48V (vedi sezione Gestione Luce).

	A (mm)	D (mm)	H (mm)	L (mm)	IP
101369.99	75W	38	49	30	168 20
101344.99	150W	38	49	30	227 20
101370.99	250W	45	55	30	318 20
101371.99	320W	78	55	35	215 20

ELECTRONIC STABILIZED DRIVER 48V
220-240V 50/60Hz
For dimming, provide 48V interfaces (see Light Management section).

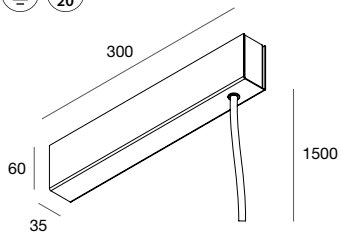

BOX CON ALIMENTAZIONE INTEGRATA 100W 48V

Box a plafone. Cavo 2x1mm² con guaina in tinta per bianco e nero e trasparente per caffè e cappuccino.

BOX WITH INTEGRATED DRIVER 100W 48V

Ceiling box. Cable 2x1mm² with matching sheath for black and white and transparent for caffè and cappuccino.

	□	■	■	■	A (mm)	H (mm)	L (mm)	Euro CHF	
112230._.	01	02	20	21	100W	35	60	300	190,50

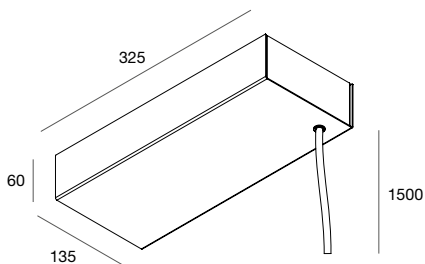
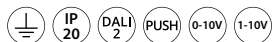

BOX CON ALIMENTAZIONE INTEGRATA DIMMERABILE 150W 48V

Box a plafone. Cavo 2x1mm² con guaina in tinta per bianco e nero e trasparente per caffè e cappuccino.

BOX WITH INTEGRATED DIMMABLE DRIVER 150W 48V

Ceiling box. Cable 2x1mm² with matching sheath for black and white and transparent for caffè and cappuccino.

	□	■	■	■	A (mm)	H (mm)	L (mm)	Euro CHF	
112232._.	01	02	20	21	150W	135	60	325	364,00





INSTALLAZIONE A SOSPENSIONE_ALIMENTAZIONE A INIZIO LINEA
SUSPENSION INSTALLATION_START OF LINE POWER CONNECTION

INSTALLAZIONE A PLAFONE_ALIMENTAZIONE A INIZIO LINEA
CEILING INSTALLATION_START OF LINE POWER CONNECTION

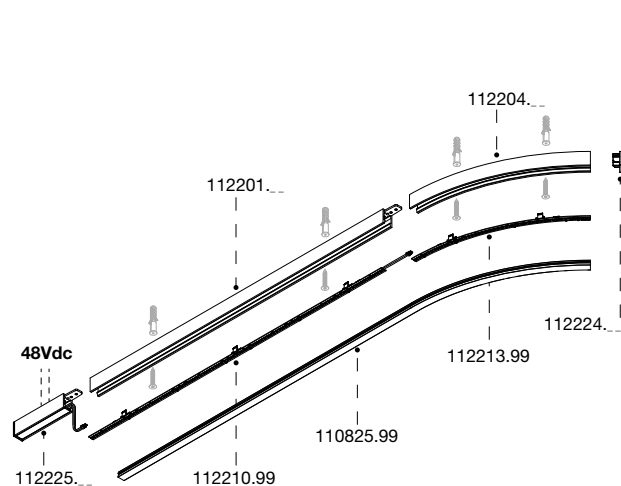
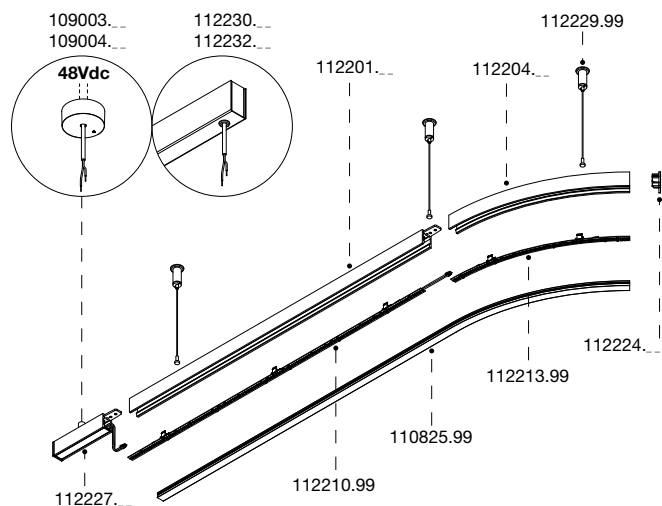

INSTALLAZIONE A SOSPENSIONE_ALIMENTAZIONE CENTRALE
SUSPENSION INSTALLATION_CENTRAL POWER CONNECTION

INSTALLAZIONE A PLAFONE_ALIMENTAZIONE CENTRALE
CEILING INSTALLATION_CENTRAL POWER CONNECTION

