



BRIDGE SYSTEM



# BRIDGE SYSTEM

SISTEMA DI SOSPENSIONI COMPONENTI  
MODULAR SUSPENSIONS SYSTEM

BRIDGE SYSTEM offre un approccio innovativo all'illuminazione, permettendoti di creare composizioni personalizzate che si adattano al tuo stile e ai tuoi spazi. Grazie a una selezione versatile di componenti, tra cui paralumi, sospensioni, rosoni e cavi, puoi configurare un sistema di illuminazione su misura per le tue esigenze. Ciò che distingue davvero BRIDGE SYSTEM è la sua flessibilità: personalizzazione e suddivisione delle accensioni, tutto da un'unica fonte di alimentazione. Questa caratteristica lo rende una soluzione ideale per case, uffici e spazi HoReCa.

BRIDGE SYSTEM offers an innovative approach to lighting, allowing you to create personalized compositions that suit your style and spaces. With a versatile selection of components, including lampshades, suspensions, canopies, and cables, you can configure a lighting system tailored to your needs. What truly sets BRIDGE SYSTEM apart is its flexibility: personalization and the ability to divide lighting zones, all from a single power source. This feature makes it an ideal solution for homes, offices, and HoReCa spaces.

**UN SISTEMA** CHE NON SI LIMITA A ILLUMINARE, MA **ESPRIME IL TUO STILE**, VALORIZZA I TUOI SPAZI E SI ADATTA CON ELEGANZA ALLA TUA VISIONE.

**A SYSTEM** THAT DOESN'T JUST ILLUMINATE, BUT **EXPRESSES YOUR STYLE**, ENHANCES YOUR SPACES, AND ELEGANTLY ADAPTS TO YOUR VISION.

Tutto parte da **un'unica fonte di alimentazione**, per semplificare e stupire.

Everything starts from **a single power source**, to simplify and to amaze.

La libertà di scegliere **cavi di lunghezze diverse** per creare installazioni dinamiche.

The freedom to **choose cables of different lengths** to create dynamic installations.



Cavi ordinati e leggeri come linee disegnate nell'aria, grazie agli **eleganti fissaggi**.

Neat and weightless cables, like lines drawn in the air thanks to **elegant fixings**.

**Ampia scelta di paralumi** per dare forma a un'illuminazione che parla il linguaggio della tua casa, del tuo studio, del tuo locale.

**A wide selection of lampshades** to shape a lighting design that speaks the language of your home, your studio, your space.



**SCEGLI IL ROSONE / CHOOSE THE CANOPY**

pag. 334



**A**  
Plafone  
Surface



**B**  
Incasso  
Recessed



**C**  
Binario  
Track



**D**  
3 cavi verticali ad interdistanza fissa  
3 vertical cables with free spacing



**E**  
max 12 cavi verticali ad interdistanza libera  
max 12 vertical cables with free spacing



**F**  
max 12 cavi orizzontali ad interdistanza libera  
max 12 horizontal cables with free spacing



**G**  
3 cavi verticali  
ad interdistanza fissa  
3 vertical cables  
with free spacing



**H**  
max 4 cavi orizzontali  
ad interdistanza libera  
max 4 horizontal cables  
with free spacing



**I**  
max 12 cavi orizzontali  
ad interdistanza libera  
max 12 horizontal cables  
with free spacing



**L**  
max 12 cavi verticali  
ad interdistanza libera  
max 12 vertical cables  
with free spacing

+



Fissaggio cavo. Obbligatorio con rosoni a cavi orizzontali  
Cable fixing. Mandatory with canopies with horizontal cables

+



Cavo + portalamпада E27 + ghiera di fissaggio  
Cable + lamp holder E27 + fixing ring



Cavo + portalamпада E27  
Cable + lamp holder E27

+



**COLLINS SP**  
pag. 336

**CRYSTAL**  
pag. 340

+



**MISS SP**  
pag. 346

+



**PATTY**  
pag. 342



**SELMA**  
pag. 342



1x CANOPY E  
112917.02

6 x CABLES +  
LAMP HOLDERS  
112918.02

6 x E27 Bulb  
not provided

3 x PATTY S  
113901.00

3 x PATTY M  
113902.00

LA LIBERTÀ DI DISEGNARE LA LUCE  
**TU LA COMONI**, LEI PRENDE FORMA

THE FREEDOM TO DESIGN LIGHT  
**YOU COMPOSE**, IT COMES TO LIFE

ESEMPI DI COMPOSIZIONI BRIDGE SYSTEM  
 BRIDGE SYSTEM COMPOSITIONS EXAMPLES

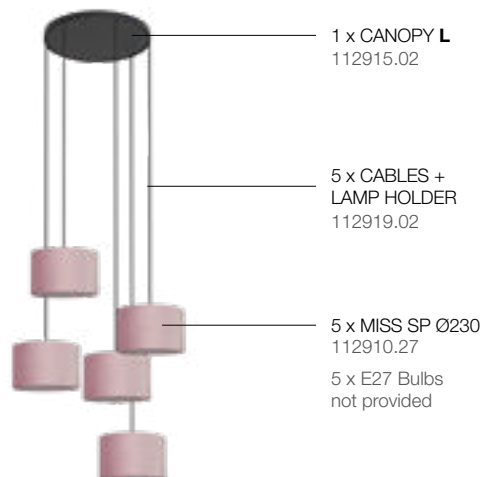
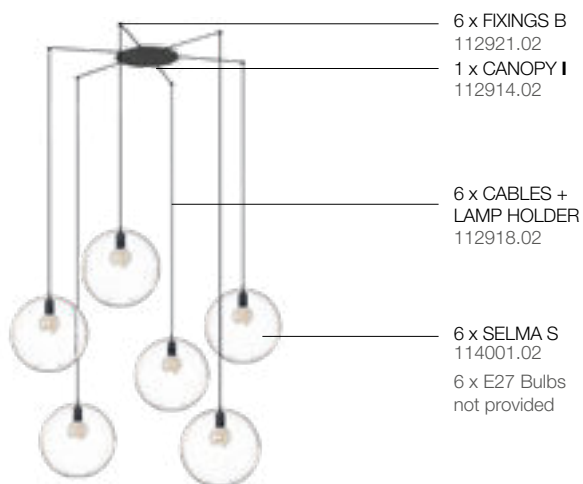
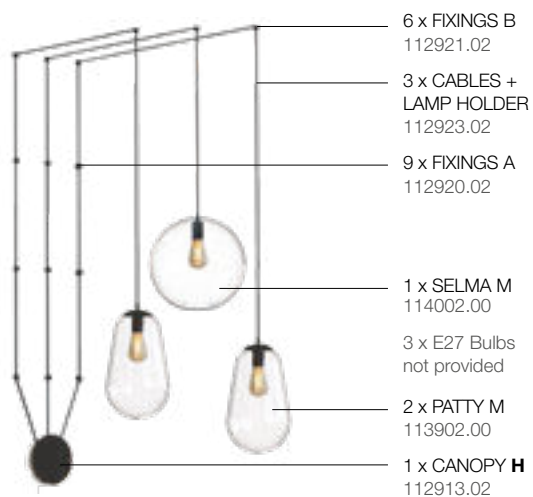
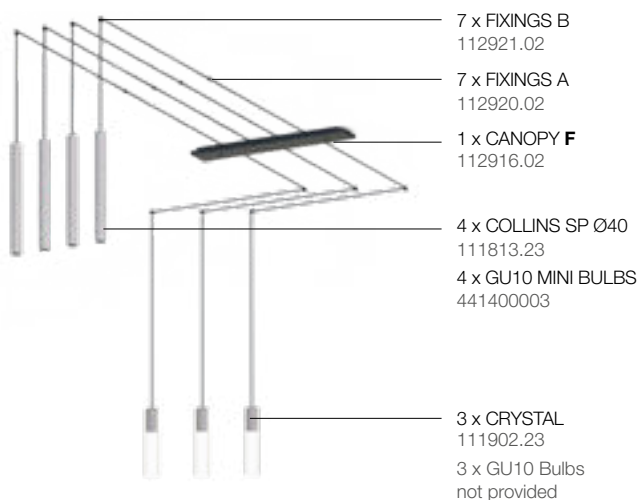
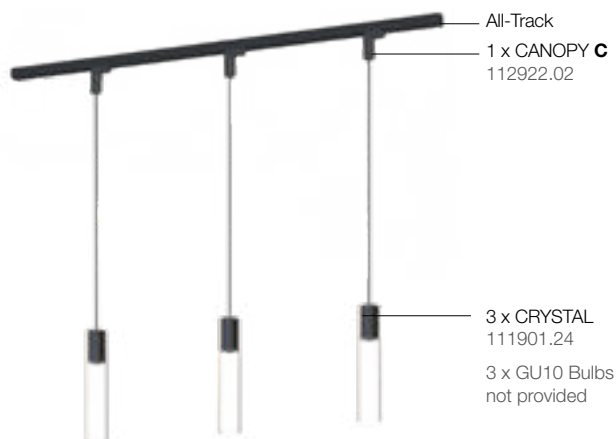
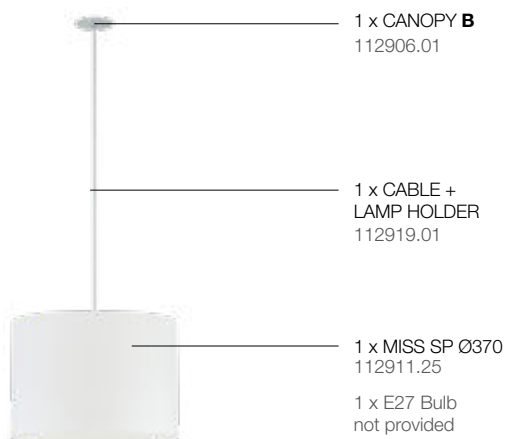

# ROSONI BRIDGE SYSTEM BRIDGE SYSTEM CANOPIES

**Collins SP** Pag. 336    **Crystal** Pag. 340    **Patty** Pag. 342    **Selma** Pag. 342    **Miss SP** Pag. 346

Rosoni singoli, multipli lineari e multipli circolari in acciaio verniciato, da combinare con uno o più apparecchi BRIDGE SYSTEM  
Single, multiple linear and multiple circular canopies in painted steel, to be combined with one or more BRIDGE SYSTEM fixtures

## ROSONI SINGOLI SINGLE CANOPIES

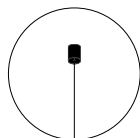

**ROSONE A**  
Plafone. Da abbinare a  
1 apparecchio Bridge System

112905. \_\_ 01 02 23 24

**CANOPY A**  
Ceiling. To be combined  
with 1 Bridge System fixture

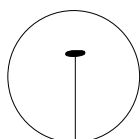
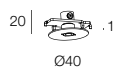

**ROSONE B**  
Incasso. Da abbinare a  
1 apparecchio Bridge System

112906. \_\_ 01 02 23 24

**CANOPY B**  
Recessed. To be combined with  
1 Bridge System fixture

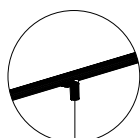
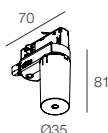

**ROSONE C**  
Binario. Da abbinare a  
1 apparecchio Bridge System  
e binario All-Track (pag. 492)

112922. \_\_ 01 02

**CANOPY C**  
Track. To be combined with  
1 Bridge System fixture  
and All-Track (pag. 492)

## ROSONI MULTIPLI LINEARI MULTIPLE LINEAR CANOPIES

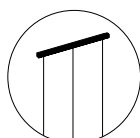
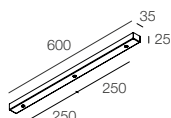

**ROSONE D**  
Per 3 cavi verticali ad interdistanza fissa.  
Da abbinare a 3 apparecchi Bridge System,  
con unica accensione.

112907. \_\_ 01 02 23 24

**CANOPY D**  
For 3 vertical cables with fix spacing.  
To be combined with 3 Bridge System fixtures,  
with single switch.

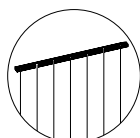
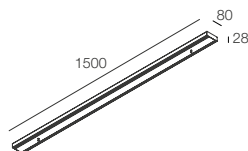

**ROSONE E**  
Per max 12 cavi verticali ad interdistanza libera.  
Da abbinare a max 12 apparecchi Bridge System,  
suddivisibili in 3 accensioni da 4 unità.

112917. \_\_ 01 02

**CANOPY E**  
For max 12 vertical cables with free spacing.  
To be combined with max 12 Bridge System  
fixtures, divisible into 3 separate switches, each  
controlling 4 units.

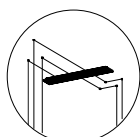
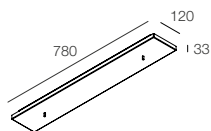

**ROSONE F**  
Per max 12 cavi orizzontali ad interdistanza libera.  
Da abbinare a max 12 apparecchi Bridge System,  
suddivisibili in 3 accensioni da 4 unità. Prevedere  
fissaggi cavi, da ordinare a parte.

112916. \_\_ 01 02

**CANOPY F**  
For max 12 horizontal cables with free spacing.  
To be combined with max 12 Bridge System  
fixtures, divisible into 3 separate switches, each  
controlling 4 units. Provide cable fixings, to be  
ordered separately.

## ROSONI MULTIPLI CIRCOLARI MULTIPLE CIRCULAR CANOPIES

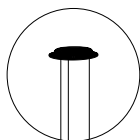
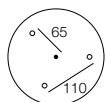
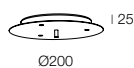

### ROSONE G

Per 3 cavi verticali ad interdistanza fissa.  
Da abbinare a 3 apparecchi Bridge System,  
con unica accensione.



112908. \_\_ 01 02 23 24

### CANOPY G

For 3 vertical cables with fix spacing.  
To be combined with 3 Bridge System fixtures,  
with single switch.

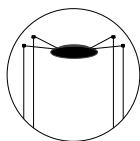
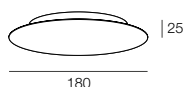

### ROSONE H

Per max 4 cavi orizzontali ad interdistanza libera.  
Da abbinare a max 4 apparecchi Bridge System,  
in unica accensione.  
Prevedere fissaggi cavi, da ordinare a parte.



112913. \_\_ 01 02

### CANOPY H

For max 4 horizontal cables with free spacing.  
To be combined with max 4 Bridge System  
fixtures, single switch.  
Provide cable fixings, to be ordered separately.

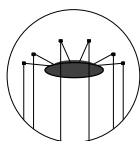
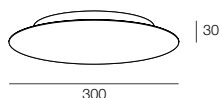

### ROSONE I

Per max 12 cavi orizzontali ad interdistanza  
libera. Da abbinare a max 12 apparecchi  
Bridge System, suddivisibili in 3 accensioni  
da 4 unità. Prevedere fissaggi cavi, da  
ordinare a parte.



112914. \_\_ 01 02

### CANOPY I

For max 12 horizontal cables with free  
spacing. To be combined with max 12  
Bridge System fixtures, divisible into 3  
separate switches, each controlling 4 units.  
Provide cable fixings, to be ordered separately.

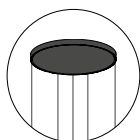
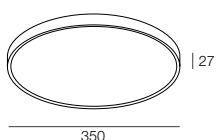

### ROSONE L

Per max 12 cavi verticali ad interdistanza libera.  
Da abbinare a max 12 apparecchi Bridge System,  
suddivisibili in 3 accensioni da 4 unità.



112915. \_\_ 01 02

### CANOPY L

For max 12 vertical cables with free spacing.  
To be combined with max 12 Bridge System  
fixtures, divisible into 3 separate switches, each  
controlling 4 units.

CANOPY	CANOPY INSTALLATION	CABLES	CABLES SPACING	MAX FIXTURES	SWITCHES	CABLE FIXINGS
A	Surface	Vertical	-	1	1	Optional
B	Recessed	Vertical	-	1	1	Optional
C	Track	Vertical	-	1	1	Optional
D	Surface	Vertical	Fix	3	1	Optional
E	Surface	Vertical	Free	12	3 x 4 units	Optional
F	Surface	Horizontal	Free	12	3 x 4 units	Mandatory
G	Surface	Vertical	Fix	3	1	Optional
H	Surface	Horizontal	Free	4	1	Mandatory
I	Surface	Horizontal	Free	12	3 x 4 units	Mandatory
L	Surface	Vertical	Free	12	3 x 4 units	Optional



PATTY  
SELMA

# PATTY SELMA



Apparecchio di illuminazione con corpo in vetro soffiato extra chiaro trasparente. Patty con calotta superiore in acciaio verniciato a polvere nero. Da completare con cavo provvisto di portalampada con attacco E27 e con accessori BRIDGE SYSTEM per realizzare composizioni a sospensione singole o multiple. Lampadine E27 non fornite.

Lighting fixture with a body in transparent extra-clear blown glass. Patty equipped with upper cap in black powder-coated steel. To be completed with a cable featuring an E27 socket and BRIDGE SYSTEM accessories for creating single or multiple suspension compositions. E27 Bulbs not provided.

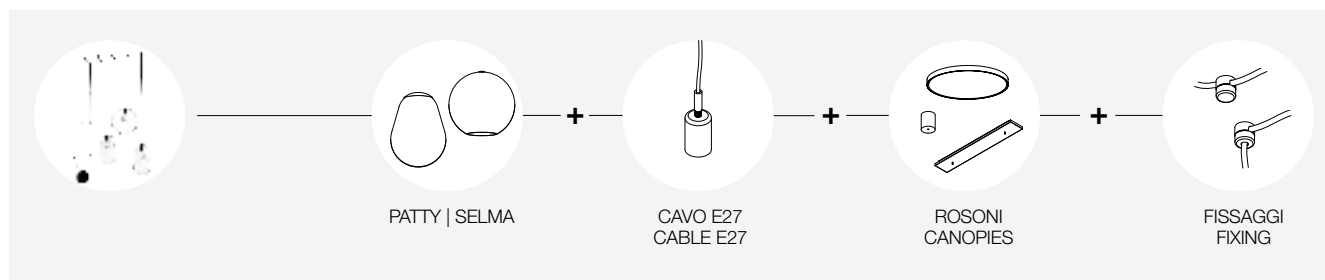

CEILING  
SUSPENSION

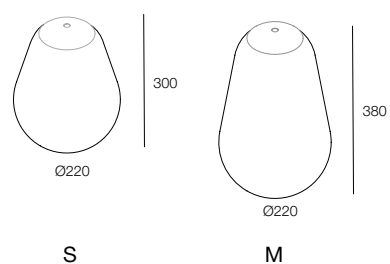

	VERSION
113901.00	S
113902.00	M

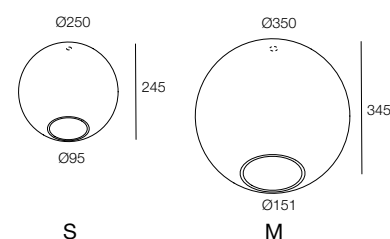

	VERSION
114001.00	S
114002.00	M

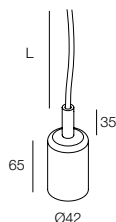

### CAVO CON PORTALAMPADA E27

Portalamпада in acciaio verniciato bianco, nero o placcato in ottone. Cavo rivestito con guaina bianca o nera. 1x E27 max 25W non inclusa

### CABLE WITH LAMP HOLDER E27

White painted steel, black, or brass-plated lamp holder. Cable coated with white or black sheath. 1x E27 max 25W not included

			L (mm)
112918. __ 01 02	E27	max 25W	3500
112923. __ 01 02	E27	max 25W	10000
<hr/>			
			L (mm)
112918. __ 16	E27	max 25W	3500
112923. __ 16	E27	max 25W	10000



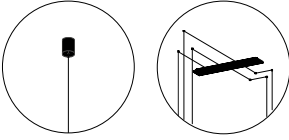

ROSONI BRIDGE SYSTEM Pag. 334

Abbinare uno o più apparecchi ai rosoni Bridge System, per sospensioni singole o multiple.

BRIDGE SYSTEM CANOPIES Page 334

Combine one or more fixtures with the Bridge System canopies, for single or multiple suspensions.

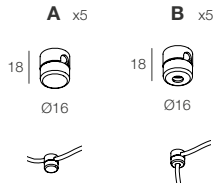

FISSAGGIO CAVO (5 pz)

In alluminio pressofuso.

Da usare obbligatoriamente con rosoni a cavi orizzontali, per fissare e tendere i cavi su soffitto o parete. Viti di montaggio non incluse.

CABLE FIXING (5 pcs)

Die-cast aluminium.

To be used mandatory with canopies with horizontal cables, to secure and tension the cable on the ceiling or wall. Mounting screws not included.

	□	■	VERSION
112920. __	01	02	A
112921. __	01	02	B



Eventuali bolle d'aria presenti sulle coppe in vetro, fino a un massimo di cinque, sono il naturale risultato del processo tecnologico di soffiatura del vetro, mantenendo inalterata la qualità e la resistenza dell'articolo.

Any air bubbles present in the glass bowls, up to a maximum of five, are the natural result of the glassblowing process and do not affect the quality or durability of the item.

