



BRIDGE SYSTEM



BRIDGE SYSTEM

SISTEMA DI SOSPENSIONI COMPONENTI
MODULAR SUSPENSIONS SYSTEM

BRIDGE SYSTEM offre un approccio innovativo all'illuminazione, permettendoti di creare composizioni personalizzate che si adattano al tuo stile e ai tuoi spazi. Grazie a una selezione versatile di componenti, tra cui paralumi, sospensioni, rosoni e cavi, puoi configurare un sistema di illuminazione su misura per le tue esigenze. Ciò che distingue davvero BRIDGE SYSTEM è la sua flessibilità: personalizzazione e suddivisione delle accensioni, tutto da un'unica fonte di alimentazione. Questa caratteristica lo rende una soluzione ideale per case, uffici e spazi HoReCa.

BRIDGE SYSTEM offers an innovative approach to lighting, allowing you to create personalized compositions that suit your style and spaces. With a versatile selection of components, including lampshades, suspensions, canopies, and cables, you can configure a lighting system tailored to your needs. What truly sets BRIDGE SYSTEM apart is its flexibility: personalization and the ability to divide lighting zones, all from a single power source. This feature makes it an ideal solution for homes, offices, and HoReCa spaces.

UN SISTEMA CHE NON SI LIMITA A ILLUMINARE, MA **ESPRIME IL TUO STILE**, VALORIZZA I TUOI SPAZI E SI ADATTA CON ELEGANZA ALLA TUA VISIONE.

A SYSTEM THAT DOESN'T JUST ILLUMINATE, BUT **EXPRESSES YOUR STYLE**, ENHANCES YOUR SPACES, AND ELEGANTLY ADAPTS TO YOUR VISION.

Tutto parte da **un'unica fonte di alimentazione**, per semplificare e stupire.

Everything starts from **a single power source**, to simplify and to amaze.

La libertà di scegliere **cavi di lunghezze diverse** per creare installazioni dinamiche.

The freedom to **choose cables of different lengths** to create dynamic installations.



Cavi ordinati e leggeri come linee disegnate nell'aria, grazie agli **eleganti fissaggi**.

Neat and weightless cables, like lines drawn in the air thanks to **elegant fixings**.

Ampia scelta di paralumi per dare forma a un'illuminazione che parla il linguaggio della tua casa, del tuo studio, del tuo locale.

A wide selection of lampshades to shape a lighting design that speaks the language of your home, your studio, your space.



SCEGLI IL ROSONE / CHOOSE THE CANOPY

pag. 334



A
Plafone
Surface



B
Incasso
Recessed



C
Binario
Track



D
3 cavi verticali ad interdistanza fissa
3 vertical cables with free spacing



E
max 12 cavi verticali ad interdistanza libera
max 12 vertical cables with free spacing



F
max 12 cavi orizzontali ad interdistanza libera
max 12 horizontal cables with free spacing



G
3 cavi verticali
ad interdistanza fissa
3 vertical cables
with free spacing



H
max 4 cavi orizzontali
ad interdistanza libera
max 4 horizontal cables
with free spacing



I
max 12 cavi orizzontali
ad interdistanza libera
max 12 horizontal cables
with free spacing



L
max 12 cavi verticali
ad interdistanza libera
max 12 vertical cables
with free spacing

+



Fissaggio cavo. Obbligatorio con rosoni a cavi orizzontali
Cable fixing. Mandatory with canopies with horizontal cables

+



Cavo + portalamпада E27 + ghiera di fissaggio
Cable + lamp holder E27 + fixing ring



Cavo + portalamпада E27
Cable + lamp holder E27

+



COLLINS SP
pag. 336

CRYSTAL
pag. 340

+



MISS SP
pag. 346

+



PATTY
pag. 342



SELMA
pag. 342



1x CANOPY E
112917.02

6 x CABLES +
LAMP HOLDERS
112918.02

6 x E27 Bulb
not provided

3 x PATTY S
113901.00

3 x PATTY M
113902.00

LA LIBERTÀ DI DISEGNARE LA LUCE
TU LA COMIONI, LEI PRENDE FORMA

THE FREEDOM TO DESIGN LIGHT
YOU COMPOSE, IT COMES TO LIFE

ESEMPI DI COMPOSIZIONI BRIDGE SYSTEM
BRIDGE SYSTEM COMPOSITIONS EXAMPLES

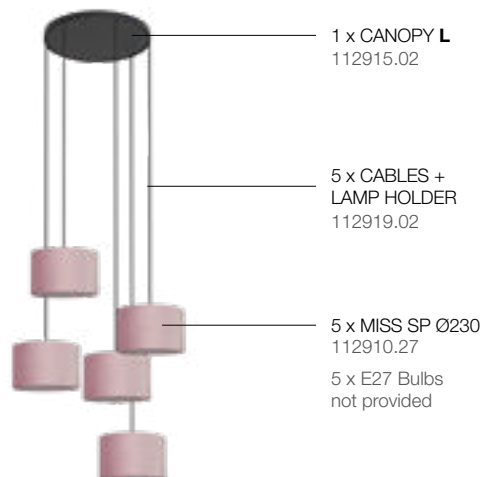
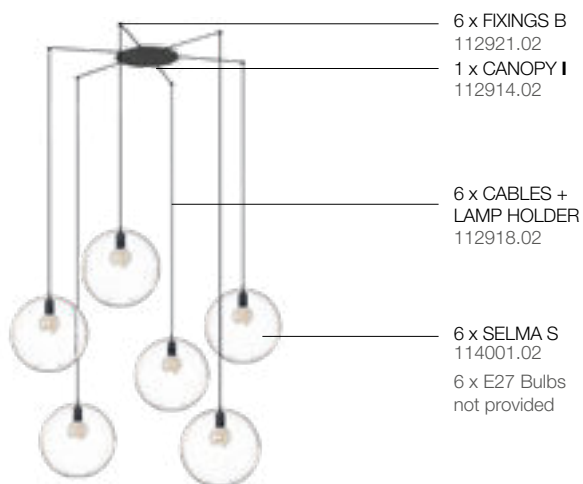
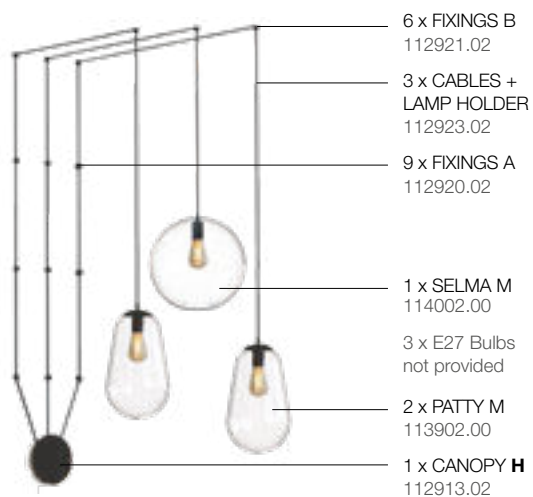
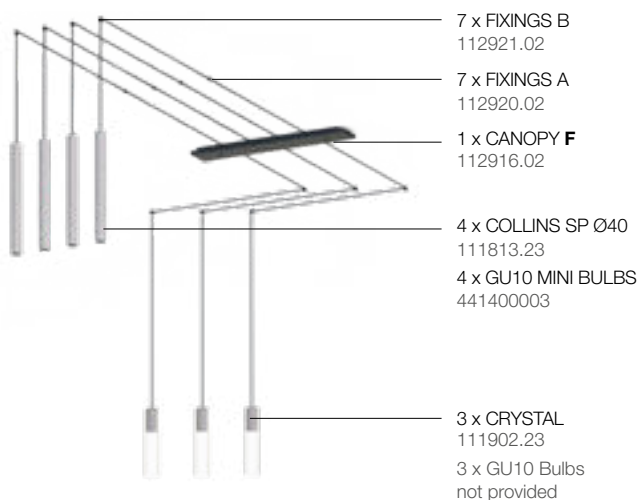
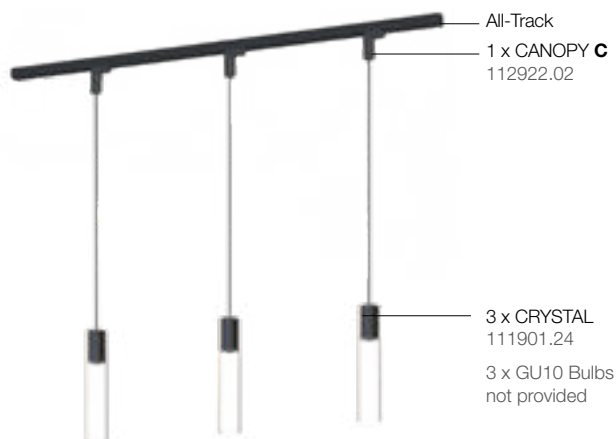
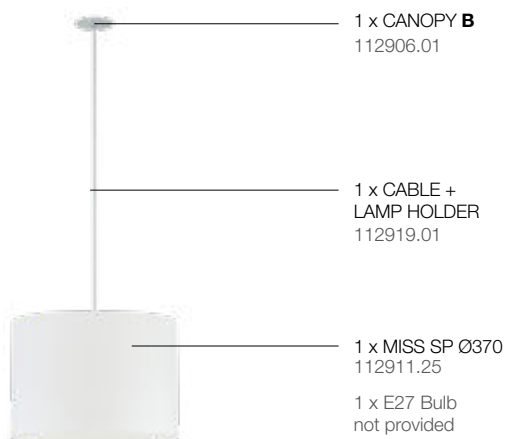

ROSONI BRIDGE SYSTEM BRIDGE SYSTEM CANOPIES

Collins SP Pag. 336 **Crystal** Pag. 340 **Patty** Pag. 342 **Selma** Pag. 342 **Miss SP** Pag. 346

Rosoni singoli, multipli lineari e multipli circolari in acciaio verniciato, da combinare con uno o più apparecchi BRIDGE SYSTEM
Single, multiple linear and multiple circular canopies in painted steel, to be combined with one or more BRIDGE SYSTEM fixtures

ROSONI SINGOLI SINGLE CANOPIES

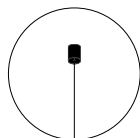

ROSONE A
Plafone. Da abbinare a
1 apparecchio Bridge System

112905. __ 01 02 23 24

CANOPY A
Ceiling. To be combined
with 1 Bridge System fixture

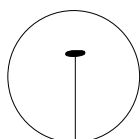
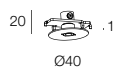

ROSONE B
Incasso. Da abbinare a
1 apparecchio Bridge System

112906. __ 01 02 23 24

CANOPY B
Recessed. To be combined with
1 Bridge System fixture

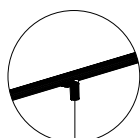
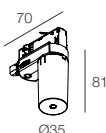

ROSONE C
Binario. Da abbinare a
1 apparecchio Bridge System
e binario All-Track (pag. 492)

112922. __ 01 02

CANOPY C
Track. To be combined with
1 Bridge System fixture
and All-Track (pag. 492)

ROSONI MULTIPLI LINEARI MULTIPLE LINEAR CANOPIES

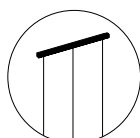
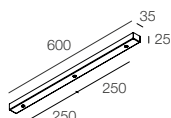

ROSONE D
Per 3 cavi verticali ad interdistanza fissa.
Da abbinare a 3 apparecchi Bridge System,
con unica accensione.

112907. __ 01 02 23 24

CANOPY D
For 3 vertical cables with fix spacing.
To be combined with 3 Bridge System fixtures,
with single switch.

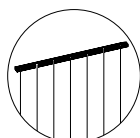
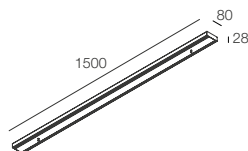

ROSONE E
Per max 12 cavi verticali ad interdistanza libera.
Da abbinare a max 12 apparecchi Bridge System,
suddivisibili in 3 accensioni da 4 unità.

112917. __ 01 02

CANOPY E
For max 12 vertical cables with free spacing.
To be combined with max 12 Bridge System
fixtures, divisible into 3 separate switches, each
controlling 4 units.

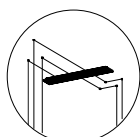
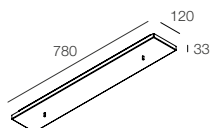

ROSONE F
Per max 12 cavi orizzontali ad interdistanza libera.
Da abbinare a max 12 apparecchi Bridge System,
suddivisibili in 3 accensioni da 4 unità. Prevedere
fissaggi cavi, da ordinare a parte.

112916. __ 01 02

CANOPY F
For max 12 horizontal cables with free spacing.
To be combined with max 12 Bridge System
fixtures, divisible into 3 separate switches, each
controlling 4 units. Provide cable fixings, to be
ordered separately.

ROSONI MULTIPLI CIRCOLARI MULTIPLE CIRCULAR CANOPIES

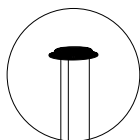
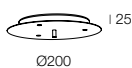

ROSONE G

Per 3 cavi verticali ad interdistanza fissa.
Da abbinare a 3 apparecchi Bridge System,
con unica accensione.



112908. __ 01 02 23 24

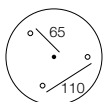

CANOPY G

For 3 vertical cables with fix spacing.
To be combined with 3 Bridge System fixtures,
with single switch.

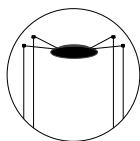
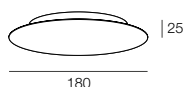

ROSONE H

Per max 4 cavi orizzontali ad interdistanza libera.
Da abbinare a max 4 apparecchi Bridge System,
in unica accensione.
Prevedere fissaggi cavi, da ordinare a parte.



112913. __ 01 02

CANOPY H

For max 4 horizontal cables with free spacing.
To be combined with max 4 Bridge System
fixtures, single switch.
Provide cable fixings, to be ordered separately.

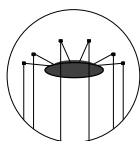
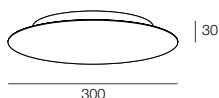

ROSONE I

Per max 12 cavi orizzontali ad interdistanza
libera. Da abbinare a max 12 apparecchi
Bridge System, suddivisibili in 3 accensioni
da 4 unità. Prevedere fissaggi cavi, da
ordinare a parte.



112914. __ 01 02

CANOPY I

For max 12 horizontal cables with free
spacing. To be combined with max 12
Bridge System fixtures, divisible into 3
separate switches, each controlling 4 units.
Provide cable fixings, to be ordered separately.

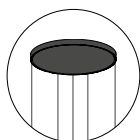
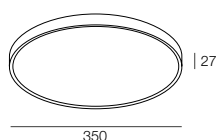

ROSONE L

Per max 12 cavi verticali ad interdistanza libera.
Da abbinare a max 12 apparecchi Bridge System,
suddivisibili in 3 accensioni da 4 unità.



112915. __ 01 02

CANOPY L

For max 12 vertical cables with free spacing.
To be combined with max 12 Bridge System
fixtures, divisible into 3 separate switches, each
controlling 4 units.

CANOPY	CANOPY INSTALLATION	CABLES	CABLES SPACING	MAX FIXTURES	SWITCHES	CABLE FIXINGS
A	Surface	Vertical	-	1	1	Optional
B	Recessed	Vertical	-	1	1	Optional
C	Track	Vertical	-	1	1	Optional
D	Surface	Vertical	Fix	3	1	Optional
E	Surface	Vertical	Free	12	3 x 4 units	Optional
F	Surface	Horizontal	Free	12	3 x 4 units	Mandatory
G	Surface	Vertical	Fix	3	1	Optional
H	Surface	Horizontal	Free	4	1	Mandatory
I	Surface	Horizontal	Free	12	3 x 4 units	Mandatory
L	Surface	Vertical	Free	12	3 x 4 units	Optional



COLLEZIONE MISS | MISS COLLECTION



MISS PL
352

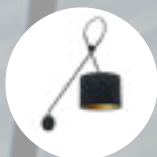

MISS PR
392

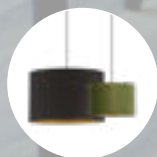

MISS SP
346



MISS SP



Paralume in velluto o in tessuto per installazione a sospensione. Da completare con cavo provvisto di portalampada con attacco E27 e ghiera di fissaggio, da abbinare con rosoni BRIDGE SYSTEM per realizzare composizioni a sospensione singole o multiple. Lampadine E27 non fornite.

Lampshade in velvet or fabric for suspension installation. To be completed with a cable featuring an E27 socket and fixing ring, to be paired with BRIDGE SYSTEM canopies for creating single or multiple suspension compositions. E27 Bulbs not provided.

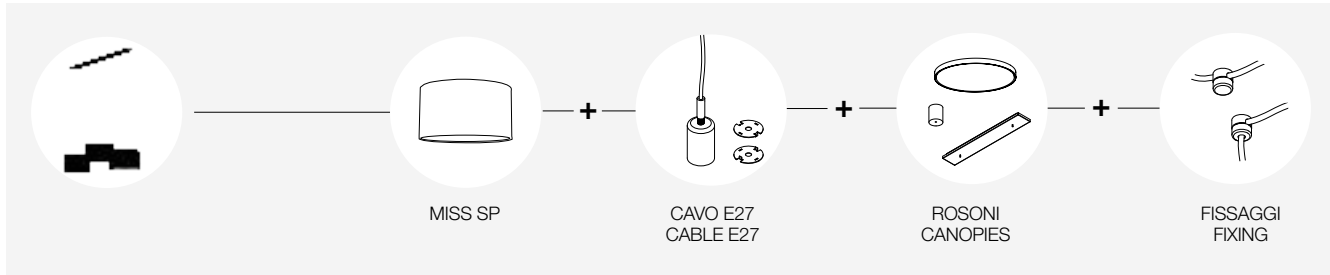

CEILING
SUSPENSION

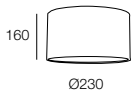

MISS SP Ø230

	□	■			
112910. __	25	26			
	■	■	■	■	■
112910. __	27	28	29		

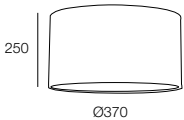

MISS SP Ø370

	□	■			
112911. __	25	26			
	■	■	■	■	■
112911. __	27	28	29		

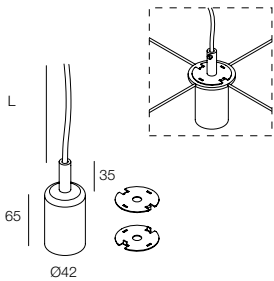

CAVO CON PORTALAMPADA E27
Portalampada in acciaio verniciato bianco, nero o placcato in ottone. Cavo rivestito con guaina bianca o nera.
1x E27 max 25W non inclusa

CABLE WITH LAMP HOLDER E27
White painted steel, black, or brass-plated lamp holder. Cable coated with white or black sheath.
1x E27 max 25W not included

	□	■				L (mm)
112919. __	01	02	E27	max 25W	3500	
112924. __	01	02	E27	max 25W	10000	
	■					L (mm)
112919. __	16		E27	max 25W	3500	
112924. __	16		E27	max 25W	10000	



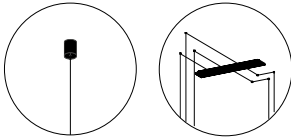

ROSONI BRIDGE SYSTEM Pag. 334

Abbinare uno o più apparecchi ai rosoni Bridge System, per sospensioni singole o multiple.

BRIDGE SYSTEM CANOPIES Page 334

Combine one or more fixtures with the Bridge System canopies, for single or multiple suspensions.

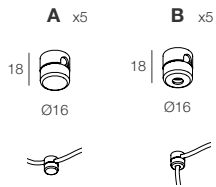

FISSAGGIO CAVO (5 pz)

In alluminio pressofuso.

Da usare obbligatoriamente con rosoni a cavi orizzontali, per fissare e tendere i cavi su soffitto o parete. Viti di montaggio non incluse.

CABLE FIXING (5 pcs)

Die-cast aluminium.

To be used mandatory with canopies with horizontal cables, to secure and tension the cable on the ceiling or wall. Mounting screws not included.

	□	■	VERSION
112920. __	01	02	A
112921. __	01	02	B



PARALUME

.25 Tessuto bianco, interno bianco

SHADE

.25 White canvas, inside white



PARALUME

.26 Tessuto nero, interno oro

SHADE

.26 Black canvas, inside gold



PARALUME

.27 Velluto rosa, interno bianco

SHADE

.27 Pink velvet, inside white



PARALUME

.28 Velluto blu, interno oro

SHADE

.28 Blue velvet, inside gold



PARALUME

.29 Velluto verde, interno oro

SHADE

.29 Green velvet, inside gold

