



L-09 / L-09 WALL

Un sistema di illuminazione che presenta tutti i vantaggi delle linee di luce incassate Cartoon Light, accostando la semplicità del cartongesso alla tecnologia delle sorgenti LED.

Un prodotto di illuminazione Novalux minimale, ma con il massimo della praticità di installazione e la versatilità di soluzioni luminose compositive.

A lighting system with all the advantages of Cartoon Light recessed light lines, combining the simplicity of plasterboard with the technology of LED sources.

A minimalist Novalux lighting product with maximum practicality of installation and versatility of compositional lighting solutions.

L-09 / L-09 WALL

- **LUNGHEZZA TAGLIABILE A MISURA**
LENGTH TO BE CUT TO MEASURE ON SITE
- **ALTEZZA COMPRESA NELLO SPESSORE DELLA LASTRA DI CARTONGESSO**
HEIGHT OF PROFILE CONCEALED IN THE THICKNESS OF PLASTERBOARD
- **PROFILI ANGOLARI GIÀ PRONTI**
PREFABRICATED ANGLE PROFILES
- **VERSIONE HYDRO PER AMBIENTI UMIDI (UMIDITÀ RELATIVA COSTANTE $\leq 70\%$)**
HYDRO VERSION FOR HUMID ENVIRONMENTS (CONSTANT RELATIVE HUMIDITY $\leq 70\%$)
- **L-09 WALL: VERSIONE PER INSTALLAZIONE SU MURATURA**
L-09 WALL: VERSION FOR CONCRETE OR BRICK SURFACE

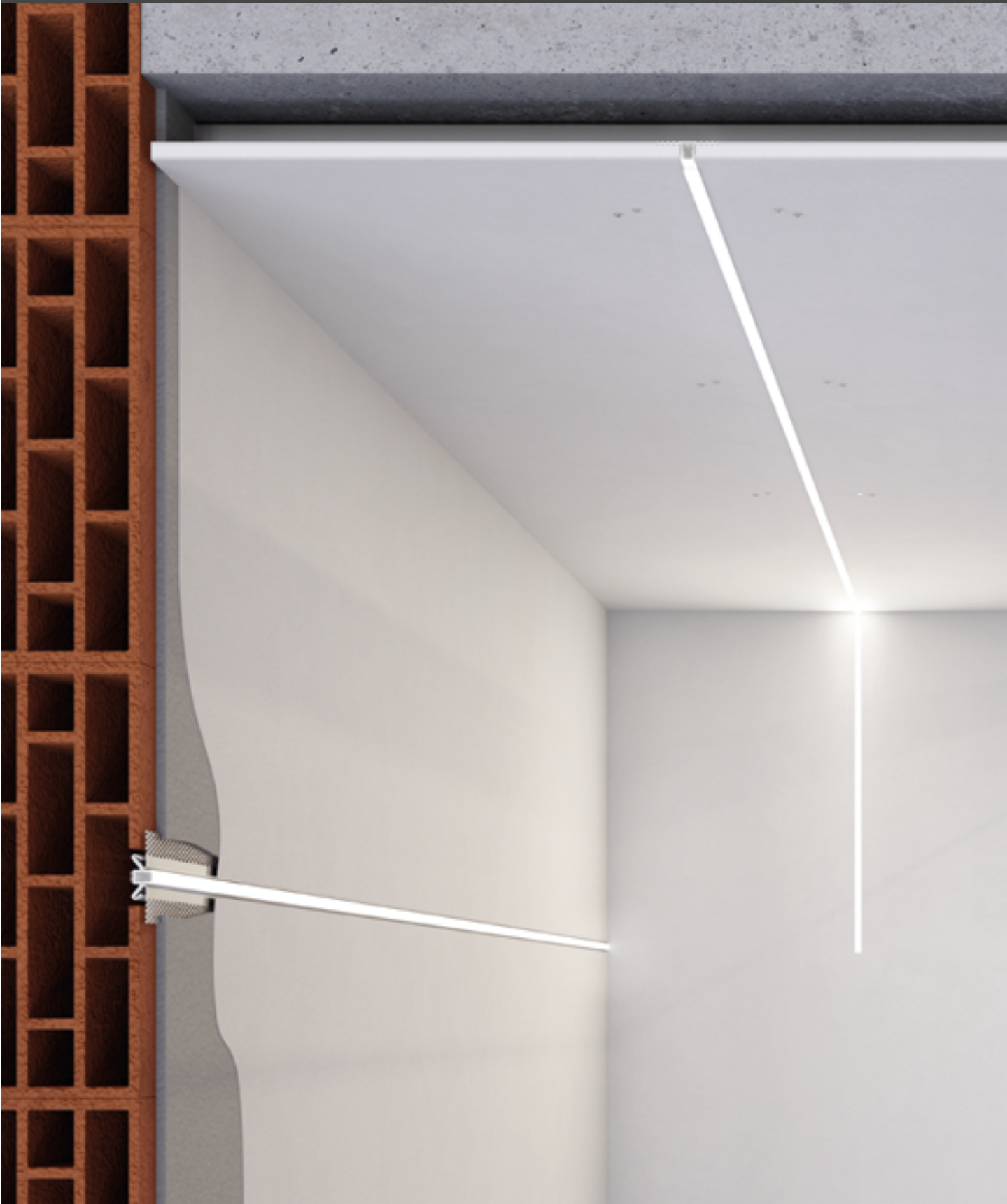

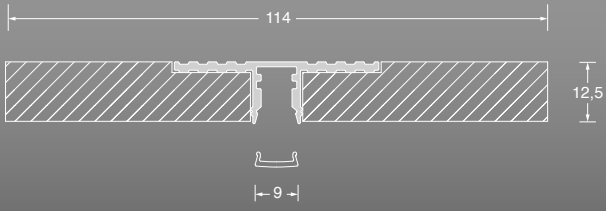

L-09

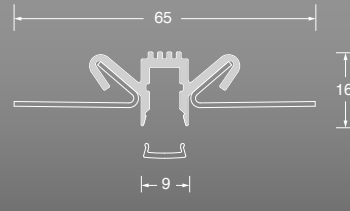

L-09 WALL



L-09

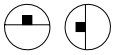

Profilo per Strip LED tagliabile in opera, per realizzare linee di luce incassate nel cartongesso.

Corpo in cartongesso di spessore 12,5 mm da lastra standard o HYDRO (a ridotto assorbimento di acqua, utilizzabile in ambienti con umidità relativa costante dell'aria $\leq 70\%$).

Profilo dissipante in lega di alluminio anodizzato naturale e schermo di protezione in PMMA opale inclusi.

Strip LED e alimentatore elettronico 24Vdc remoto da ordinare a parte. Non esporre a intemperie o luce solare diretta e non inserire in materiale isolante.

Profile for Strip LED, for light cut on plasterboard.

Body made of 12,5 mm thick plasterboard, either standard or HYDRO treated (with reduced water absorption level to be used in environments with constant relative humidity levels of air $\leq 70\%$).

Dissipating profile made of anodized aluminium alloy natural finish and PMMA opal diffuser included.

Strip LED and remote electronic driver 24Vdc to be ordered separately. Do not expose to bad weather or direct sunlight and do not insert into insulating material.

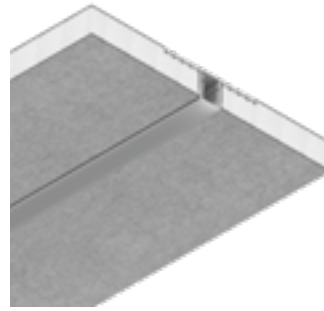

LE GARANZIE PRODOTTO SARANNO APPLICABILI, PER RAGIONI DI SICUREZZA E FRUIBILITÀ, SOLO UTILIZZANDO STRIPLED ED ALIMENTAZIONI NOVALUX. THE PRODUCT WARRANTY CONDITIONS WILL APPLY, DUE TO REASONS OF SAFETY AND QUALITY OF USE, ONLY WHEN INSTALLED WITH THE STRIPLED AND DRIVERS FROM NOVALUX CATALOGUES.

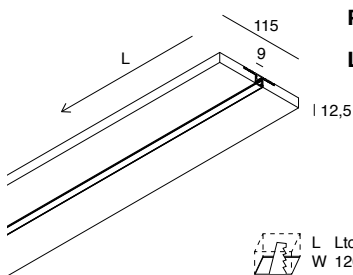

PROFILO LINEARE

LINEAR PROFILE

	L (mm)	Version
101898.99	2000	Standard
101899.99	2000	HYDRO

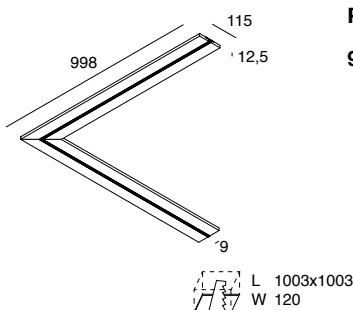

PROFILO ANGOLARE 90°

90° CORNER PROFILE

	L (mm)	Version
1018A0.99	998x998	Standard
1018A1.99	998x998	HYDRO

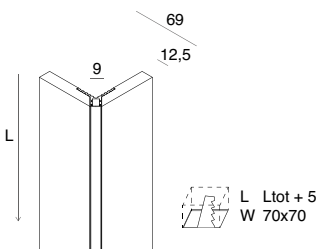

L-09 CORNER

profilo lineare per spigolo esterno non installabile direttamente su muratura

L-09 CORNER

linear profile for external corner not for direct installation on hard surfaces

	L (mm)	Version
1018A8.99	2000	Standard
1018A9.99	2000	HYDRO

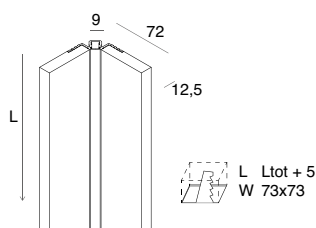

L-09 EDGE

profilo lineare per spigolo interno

L-09 EDGE

linear profile for internal corner

	L (mm)	Version
1018A6.99	2000	Standard
1018A7.99	2000	HYDRO

L-09 WALL

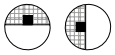

Profilo per Strip LED tagliabile in opera, per realizzare linee di luce incassate in muratura.

Profilo tagliabile in opera in lega di alluminio anodizzata naturale e rete di armatura porta-intonaco in acciaio zincato.

Schermo di protezione in PMMA opale incluso.

Strip LED e alimentatore elettronico remoto da ordinare a parte.

Non esporre a intemperie o luce solare diretta e non inserire in materiale isolante.

Profile for Strip LED for light cut on concrete or brick surface.

Length cuttable on measure on site.

Profile made of aluminium alloy and galvanized steel grid to plaster.

PMMA protection screen included.

Strip LED and remote electronic driver to be ordered separately.

Do not expose to bad weather or direct sunlight and do not insert into insulating material.



LE GARANZIE PRODOTTO SARANNO APPLICABILI, PER RAGIONI DI SICUREZZA E FRUIBILITÀ, SOLO UTILIZZANDO STRIPLED ED ALIMENTAZIONI NOVALUX.
THE PRODUCT WARRANTY CONDITIONS WILL APPLY, DUE TO REASONS OF SAFETY AND QUALITY OF USE, ONLY WHEN INSTALLED WITH THE STRIPLED AND DRIVERS FROM NOVALUX CATALOGUES.

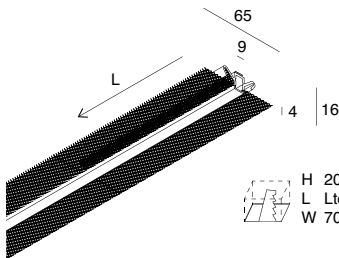

PROFILO LINEARE

LINEAR PROFILE

	L (mm)
1018B0.99	2000

L-09 L-09 WALL

ACCESSORI ACCESSORIES

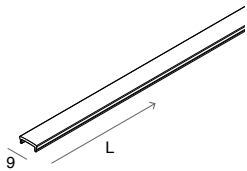

SCHERMO OPALE 6 m
opzionale
Consigliato per installazioni in fila continua

OPAL SCREEN 6 m
optional
Recommended for continuous line installations

	L (mm)	
1018A2.99	6000	Opale / Opal

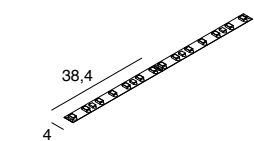

STRIP LED 4mm
11,5W/m

	L (mm)	lm/m	IP	CRI
100913.99	5000	2700K	1100	20 90
100914.99	5000	3000K	1014	20 90
100915.99	5000	4000K	1154	20 90
100928.99	5000	2700K	1016	65 90
100929.99	5000	3000K	1038	65 90
100930.99	5000	4000K	1124	65 90

SMD 2216 (182 LED/m)
Biadesivo - sezionabile ogni 38,4 mm (7 LED)
Biadesive - cuttable every 38,4 mm (7 LED)



