





## HERO

HERO è il sistema lineare LED Novalux per installazione a sospensione, plafone, parete o incasso a rasamento in cartongesso. Performante e flessibile, grazie alla ricca varietà di ottiche LED ad alta resa cromatica. Ci sono differenti ottiche: emissione di luce diffusa con schermo opale, tutta luce o UGR<19, micro ottiche o cover con spot orientabili.

HERO is the Novalux LED linear system for pendant, ceiling, wall or levelled recessed installation in plasterboard. Performing and flexible, thanks to the rich variety of LED optics with high colour rendering. There are different optics: diffuse light emission with opal screen, full light or UGR<19, micro-optics or cover with adjustable spots.

# HERO

- **VERSIONI CON SCHERMO OPALE, UGR<19, MICRO OTTICHE, TUTTA LUCE, SPOT LED E MODULI CIECHI**

OPAL DIFFUSER, UGR<19, FULL LIGHT, MICRO-OPTICS, SPOT LED VERSIONS AND BLIND MODULES

- **MODULO CON SENSORE INTEGRATO PER RILEVAMENTO PRESENZA E LUMINOSITÀ**

MODULE WITH INTEGRATED PRESENCE DETECTOR AND LIGHT SENSOR

- **MODULO CON FARETTO INCASSATO CON FUNZIONE SOLO EMERGENZA**

MODULE WITH RECESSED SPOT LIGHT FOR NOT MAINTAINED FUNCTION

- **CRI>90**

- **CONNETTORI RAPIDI PER INSTALLAZIONE IN FILA CONTINUA**

RAPID CONNECTORS FOR CONTINUOUS LINE INSTALLATION



## FINITURE FINISH



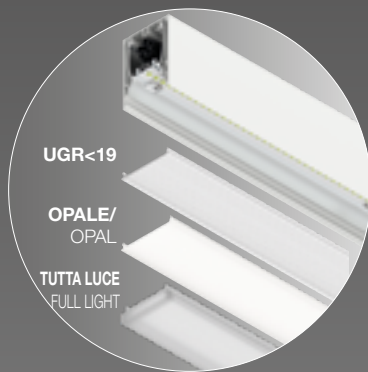
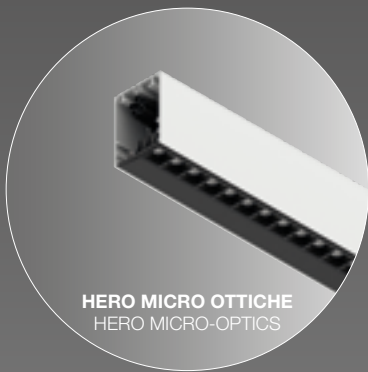
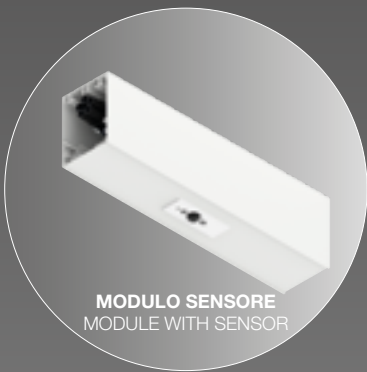
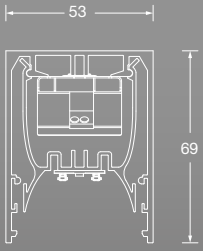

# HERO



Sistema LED lineare installabile singolo o in fila continua, a plafone, sospensione, incasso in controsoffitto, a parete o a binario.

Stand alone or continuous line LED system for ceiling, wall surface, suspended, recessed in plasterboard ceiling, or on track.

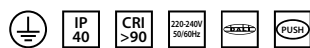
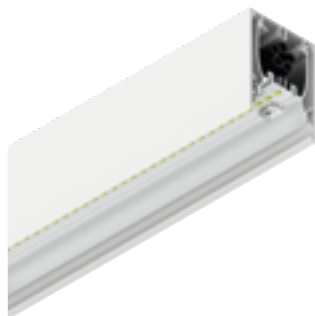

## PROFILO LED

Profilo in lega di alluminio verniciato. Alimentazione elettronica, cablaggio passante e giunti di unione inclusi. Schermo, testate terminali, accessori per la sospensione, l'incasso e l'installazione a parete da ordinare a parte.

## LED PROFILE

Painted alloy aluminium profile. Electronic power supply, through wiring and junction kit included. Screen, end caps, accessories for suspension, recessed and wall installation to be ordered separately.

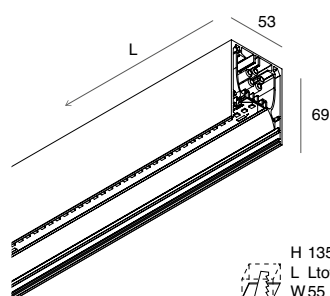

## PROFILO LED LINEARE

## LINEAR LED PROFILE

Autonomia 1h / Ricarica 12h  
Autonomy 1h / Charging 12h

Autonomia 1h / Ricarica 12h  
Autonomy 1h / Charging 12h

L (mm)		2700K	3000K	4000K	□	■	■	■
1120	24W	<b>108601</b> ...	<b>108608</b> ...	<b>108615</b> ...	01	02	20	21
1400	30W	<b>108602</b> ...	<b>108609</b> ...	<b>108616</b> ...	01	02	20	21
1680	36W	<b>108603</b> ...	<b>108610</b> ...	<b>108617</b> ...	01	02	20	21
1960	42W	<b>108604</b> ...	<b>108611</b> ...	<b>108618</b> ...	01	02	20	21
2240	48W	<b>108605</b> ...	<b>108612</b> ...	<b>108619</b> ...	01	02	20	21
2520	54W	<b>108606</b> ...	<b>108613</b> ...	<b>108620</b> ...	01	02	20	21
2800	59W	<b>108607</b> ...	<b>108614</b> ...	<b>108621</b> ...	01	02	20	21

## DALI-PUSH

L (mm)		2700K	3000K	4000K	□	■	■	■
1120	24W	<b>108640</b> ...	<b>108647</b> ...	<b>108654</b> ...	01	02	20	21
1400	30W	<b>108641</b> ...	<b>108648</b> ...	<b>108655</b> ...	01	02	20	21
1680	36W	<b>108642</b> ...	<b>108649</b> ...	<b>108656</b> ...	01	02	20	21
1960	42W	<b>108643</b> ...	<b>108650</b> ...	<b>108657</b> ...	01	02	20	21
2240	48W	<b>108644</b> ...	<b>108651</b> ...	<b>108658</b> ...	01	02	20	21
2520	54W	<b>108645</b> ...	<b>108652</b> ...	<b>108659</b> ...	01	02	20	21
2800	59W	<b>108646</b> ...	<b>108653</b> ...	<b>108660</b> ...	01	02	20	21

## EMERGENCY 1 h Flusso in emergenza / Emergency flux 10%

L (mm)		2700K	3000K	4000K	□	■	■	■
1680	36W	<b>108622</b> ...	<b>108623</b> ...	<b>108624</b> ...	01	02	20	21

## DALI-PUSH + EMERGENCY 1 h Flusso in emergenza / Emergency flux 10%

L (mm)		2700K	3000K	4000K	□	■	■	■
1680	36W	<b>108696</b> ...	<b>108697</b> ...	<b>108698</b> ...	01	02	20	21

Prevedere cavo di alimentazione dedicato per il modulo DALI-PUSH + EME.  
Provide specific power supply cable for DALI-PUSH + EME module.

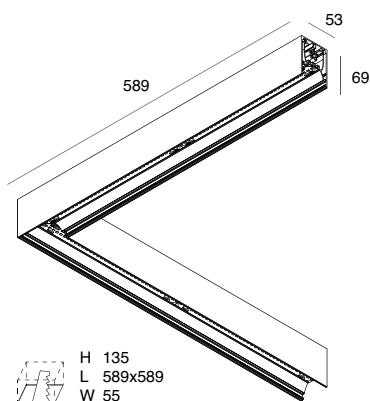

## PROFILO LED ANGOLARE 90°

Alimentazione elettronica, cablaggio passante e giunti di unione inclusi.

## 90° CORNER LED PROFILE

Electronic power supply, through wiring and junction kit included.

## Sinistra/Left

L (mm)		2700K	3000K	4000K	□	■	■	■
589x589	24W	<b>108625</b> ...	<b>108626</b> ...	<b>108627</b> ...	01	02	20	21

## Destra/Right

L (mm)		2700K	3000K	4000K	□	■	■	■
589x589	24W	<b>108628</b> ...	<b>108629</b> ...	<b>108630</b> ...	01	02	20	21

## DALI-PUSH Sinistra/Left

L (mm)		2700K	3000K	4000K	□	■	■	■
589x589	24W	<b>108661</b> ...	<b>108662</b> ...	<b>108663</b> ...	01	02	20	21

## DALI-PUSH Destra/Right

L (mm)		2700K	3000K	4000K	□	■	■	■
589x589	24W	<b>108664</b> ...	<b>108665</b> ...	<b>108666</b> ...	01	02	20	21

## HERO

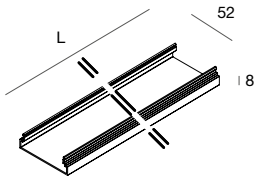
ACCESSORI  
ACCESSORIES**DIFFUSORE TUTTA LUCE**

Diffusore sporgente in policarbonato opale.  
Testate opali da ordinare a parte.

**FULL LIGHT DIFFUSER**

Protruding opal polycarbonate diffuser.  
Opal end caps to be ordered separately.

L (mm)	2700K	3000K	4000K	
1120	2131 lm	2168 lm	2397 lm	<b>108923.99</b>
1400	2664 lm	2710 lm	2996 lm	<b>108924.99</b>
1680	3197 lm	3253 lm	3596 lm	<b>108925.99</b>
1960	3730 lm	3794 lm	4195 lm	<b>108926.99</b>
2240	4263 lm	4337 lm	4795 lm	<b>108927.99</b>
2520	4796 lm	4879 lm	5394 lm	<b>108928.99</b>
2800	5329 lm	5421 lm	5993 lm	<b>108929.99</b>

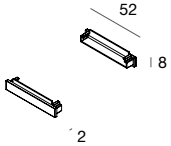
**TESTATE OPALI (2pz)**

Da prevedere alle estremità dello schermo tutta luce.

**108930.99****OPAL END CAPS (2pcs)**

To be provided at the end of full light diffuser.

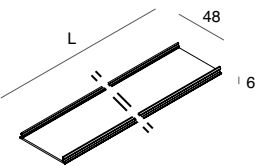
**DIFFUSORE OPALE LINEARE**

Schermo diffusore ad incastro in policarbonato opale.

**LINEAR OPAL DIFFUSER**

Opal polycarbonate diffuser.

L (mm)	2700K	3000K	4000K	
1120	1909 lm	1942 lm	2147 lm	<b>108901.99</b>
1400	2386 lm	2427 lm	2683 lm	<b>108902.99</b>
1680	2863 lm	2913 lm	3220 lm	<b>108903.99</b>
1960	3340 lm	3398 lm	3757 lm	<b>108904.99</b>
2240	3818 lm	3884 lm	4294 lm	<b>108905.99</b>
2520	4295 lm	4369 lm	4830 lm	<b>108906.99</b>
2800	4772 lm	4855 lm	5367 lm	<b>108907.99</b>
* 5700	-	-	-	<b>108909.99</b>

\* Schermo 5700mm consigliato per installazioni in fila continua  
5700mm screen recommended for continuous line installations

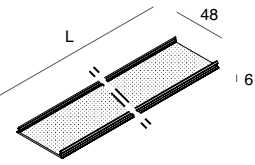
UGR  
<19**DIFFUSORE UGR<19 LINEARE**

Schermo diffusore per il controllo dell'abbagliamento, ad incastro in policarbonato microprismatizzato.

**UGR<19 DIFFUSER LINEAR**

Anti-glare diffuser made of microprismatized polycarbonate.

L (mm)	2700K	3000K	4000K	
1120	2086 lm	2131 lm	2355 lm	<b>108910.99</b>
1400	2607 lm	2663 lm	2943 lm	<b>108911.99</b>
1680	3129 lm	3196 lm	3532 lm	<b>108912.99</b>
1960	3650 lm	3729 lm	4121 lm	<b>108913.99</b>
2240	4172 lm	4262 lm	4710 lm	<b>108914.99</b>
2520	4693 lm	4794 lm	5298 lm	<b>108915.99</b>
2800	5215 lm	5327 lm	5887 lm	<b>108916.99</b>
* 5700	-	-	-	<b>108918.99</b>

\* Schermo 5700mm consigliato per installazioni in fila continua  
5700mm screen recommended for continuous line installations

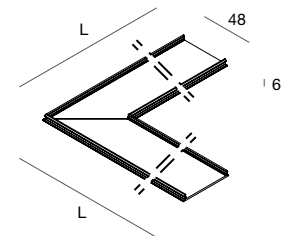
**DIFFUSORE OPALE ANGOLARE 90°**

Schermo diffusore ad incastro in policarbonato opale.

**OPAL DIFFUSER 90° CORNER**

Opal polycarbonate diffuser.

L (mm)	2700K	3000K	4000K	
589x589	1909 lm	1942 lm	2147 lm	<b>108908.99</b>

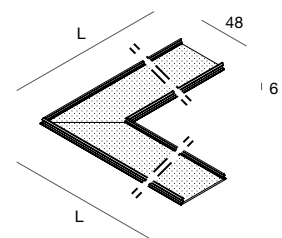
UGR  
<19**DIFFUSORE UGR<19 ANGOLARE 90°**

Schermo diffusore per il controllo dell'abbagliamento, ad incastro a filo in policarbonato microprismatizzato.

**UGR<19 DIFFUSER 90° CORNER**

Anti-glare flush diffuser made of microprismatized polycarbonate.

L (mm)	2700K	3000K	4000K	
589x589	2086 lm	2131 lm	2355 lm	<b>108917.99</b>

# HERO MICRO OTTICHE

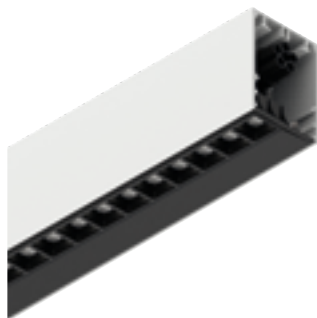
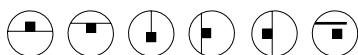

## PROFILO LED LINEARE MICRO OTTICHE

Profilo in lega di alluminio verniciato completo di micro ottiche. Alimentazione elettronica, cablaggio passante e giunti di unione inclusi. Testate terminali, accessori per la sospensione, l'incasso e l'installazione a parete da ordinare a parte.

## MICRO-OPTICS LINEAR LED PROFILE

Painted alloy aluminium profile complete with micro-optics. Electronic power supply, through wiring and junction kit included. End caps, accessories for suspension, recessed and wall installation to be ordered separately.

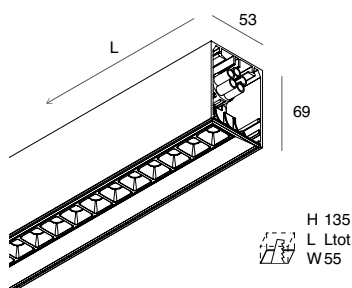

L (mm)	2700K	3000K	4000K					
868	22W 2134 lm	2183 lm	2412 lm	<b>108631</b> ...	<b>108633</b> ...	<b>108635</b> ...	<b>108636</b> ...	01 02 20 21
1428	36W 3556 lm	3638 lm	4020 lm	<b>108632</b> ...	<b>108634</b> ...	<b>108636</b> ...		01 02 20 21

## DALI-PUSH

L (mm)	2700K	3000K	4000K					
868	22W 2134 lm	2183 lm	2412 lm	<b>108667</b> ...	<b>108669</b> ...	<b>108671</b> ...	<b>108672</b> ...	01 02 20 21
1428	36W 3556 lm	3638 lm	4020 lm	<b>108668</b> ...	<b>108670</b> ...	<b>108672</b> ...		01 02 20 21

# HERO SPOT



## PROFILO LED LINEARE SPOT

Profilo in lega di alluminio verniciato completo di 2 faretti. Alimentazione elettronica, cablaggio passante e giunti di unione inclusi. Testate terminali, accessori per la sospensione e l'incasso da ordinare a parte.

## SPOT LINEAR LED PROFILE

Painted alloy aluminium profile complete with 2 spotlights. Electronic power supply, through wiring and junction kit included. End caps, accessories for suspension and recessed installation to be ordered separately.

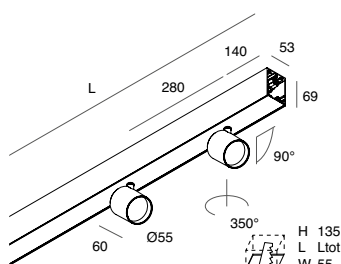

L (mm)	2700K	3000K	4000K					
1120	2x13W 14° 2028 lm	2110 lm	2332 lm	<b>108637</b> ...	<b>108638</b> ...	<b>108639</b> ...	<b>108692</b> ...	01 02 20 21
1120	2x13W 34° 2144 lm	2230 lm	2464 lm	<b>108690</b> ...	<b>108691</b> ...	<b>108692</b> ...		01 02 20 21

## DALI-PUSH

L (mm)	2700K	3000K	4000K					
1120	2x13W 14° 2028 lm	2110 lm	2232 lm	<b>108673</b> ...	<b>108674</b> ...	<b>108675</b> ...	<b>108695</b> ...	01 02 20 21
1120	2x13W 34° 2144 lm	2230 lm	2464 lm	<b>108693</b> ...	<b>108694</b> ...	<b>108695</b> ...		01 02 20 21

**HERO**

**ACCESSORI  
ACCESSORIES**

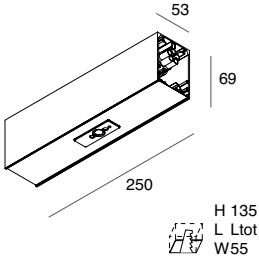

**MODULO CON CENTRALINA + SENSORE DI PRESENZA E LUMINOSITA'**  
 Completo di centralina DALI e sensore DALI integrato nella cover. Cablaggio passante e giunti di unione inclusi. Gestibili fino a 32 alimentatori e max 3 moduli sensore 1086A0... Programmabile mediante Bluetooth con App dedicata per smartphone o tablet. Gestione solo automatica. Non alimentabile.

<input type="checkbox"/>	<input checked="" type="checkbox"/>	<input checked="" type="checkbox"/>	<input checked="" type="checkbox"/>	<input checked="" type="checkbox"/>	L (mm)
<b>108682...</b>	<b>01</b>	<b>02</b>	<b>20</b>	<b>21</b>	<b>250</b>

**MODULE WITH CONTROL UNIT + PRESENCE DETECTOR AND LIGHT SENSOR**  
 Complete with DALI control unit and DALI sensor integrated in the cover. Through wiring and junction kit included. Up to 32 drivers controlled and max 3 sensor modules 1086A0... Programmable by Bluetooth with dedicated App for smartphones or tablets. Only automatic management. Without plug-in.

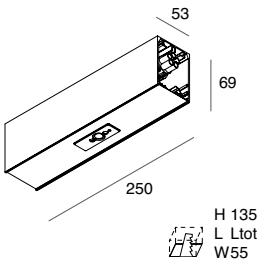

**MODULO CON SENSORE DI PRESENZA E LUMINOSITA'**  
 Completo di sensore DALI integrato nella cover, cablaggio passante e giunti di unione. Non alimentabile. Utilizzabile con modulo centralina + sensore 108682...

<input type="checkbox"/>	<input checked="" type="checkbox"/>	<input checked="" type="checkbox"/>	<input checked="" type="checkbox"/>	<input checked="" type="checkbox"/>	L (mm)
<b>1086A0...</b>	<b>01</b>	<b>02</b>	<b>20</b>	<b>21</b>	<b>250</b>

**MODULE WITH PRESENCE DETECTOR AND LIGHT SENSOR**  
 Complete with DALI sensor integrated in the cover, through wiring and junction kit. Without plug-in. Can be used with control unit + sensor module 108682...

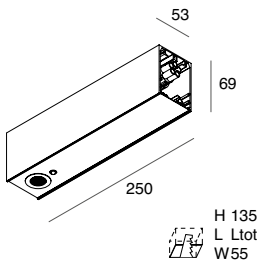

**MODULO CON FARETTO INCASSATO 1W CON FUNZIONE SOLO EMERGENZA (SE) COMPATIBILE CON CABLAGGI ON/OFF**  
 Completo di faretto integrato nella cover, kit inverter batteria, cablaggio passante e giunti di unione. Non utilizzabile per ingresso alimentazione di file continue.

<input type="checkbox"/>	<input checked="" type="checkbox"/>	<input checked="" type="checkbox"/>	<input checked="" type="checkbox"/>	<input checked="" type="checkbox"/>	L (mm)		
<b>108683...</b>	<b>01</b>	<b>02</b>	<b>20</b>	<b>21</b>	<b>250</b>	<b>1W</b>	<b>140lm</b>

Autonomia 3h / Ricarica 24h. Flusso in emergenza 100%  
 Autonomy 3h / Charging 24h. Emergency flux 100%

**MODULE WITH 1W RECESSED SPOTLIGHT FOR NOT MAINTAINED FUNCTION (N/M) SUITABLE FOR ON/OFF WIRING**  
 Complete with spotlight integrated in the cover, through wiring and junction kit. Do not use to power continuous lines.

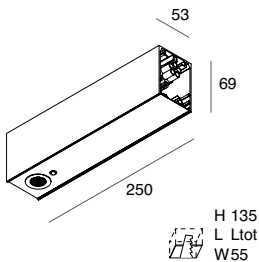

**MODULO CON FARETTO INCASSATO 1W CON FUNZIONE SOLO EMERGENZA (SE) COMPATIBILE CON CABLAGGI DALI-PUSH**  
 Completo di faretto ON/OFF integrato nella cover, kit inverter batteria, cablaggio passante e giunti di unione. Non utilizzabile per ingresso alimentazione di file continue.

<b>DALI-PUSH</b>						<input type="checkbox"/>	<input checked="" type="checkbox"/>	<input checked="" type="checkbox"/>	<input checked="" type="checkbox"/>	L (mm)		
<b>108699...</b>	<b>01</b>	<b>02</b>	<b>20</b>	<b>21</b>	<b>250</b>	<b>1W</b>	<b>140lm</b>					

Autonomia 3h / Ricarica 24h. Flusso in emergenza 100%  
 Autonomy 3h / Charging 24h. Emergency flux 100%

Prevedere cavo di alimentazione dedicato per il modulo SE.  
 Provide specific power supply cable for N/M module.

**MODULE WITH 1W RECESSED SPOTLIGHT FOR NOT MAINTAINED FUNCTION (N/M) SUITABLE FOR DALI-PUSH WIRING**  
 Complete with ON/OFF spotlight integrated in the cover, through wiring and junction kit. Do not use to power continuous lines.

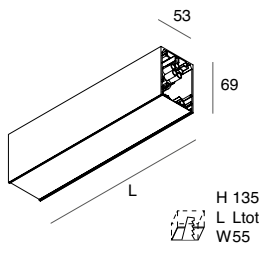

**MODULO CIECO LINEARE**  
 Completo di cablaggio passante, giunti di unione e cover inferiore. Modulo L 250mm non alimentabile, da utilizzare come compensativo in composizioni chiuse con modulo SE o con sensore integrato.

<input type="checkbox"/>	<input checked="" type="checkbox"/>	<input checked="" type="checkbox"/>	<input checked="" type="checkbox"/>	<input checked="" type="checkbox"/>	L (mm)
<b>108676...</b>	<b>01</b>	<b>02</b>	<b>20</b>	<b>21</b>	<b>250</b>
<b>108679...</b>	<b>01</b>	<b>02</b>	<b>20</b>	<b>21</b>	<b>1120</b>
<b>108680...</b>	<b>01</b>	<b>02</b>	<b>20</b>	<b>21</b>	<b>1400</b>
<b>108681...</b>	<b>01</b>	<b>02</b>	<b>20</b>	<b>21</b>	<b>1680</b>

**LINEAR BLIND MODULE**  
 Complete with through wiring, junction kit and blind cover. Module L 250mm without plug-in, to be used to compensate for compositions with N/M or integrated sensor modules.

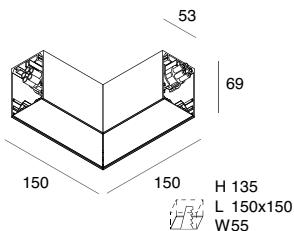

**MODULO CIECO a L**  
 Completo di cablaggio passante, giunti di unione e cover inferiore. Non alimentabile.

<input type="checkbox"/>	<input checked="" type="checkbox"/>	<input checked="" type="checkbox"/>	<input checked="" type="checkbox"/>	<input checked="" type="checkbox"/>	VERSION	L (mm)
<b>108677...</b>	<b>01</b>	<b>02</b>	<b>20</b>	<b>21</b>	sinistra/left	150x150
<b>108678...</b>	<b>01</b>	<b>02</b>	<b>20</b>	<b>21</b>	destra/right	150x150

**L BLIND MODULE**  
 Complete with through wiring, junction kit and blind cover. Without plug-in.

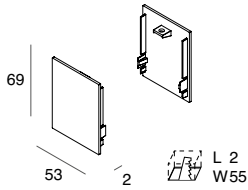

## HERO

ACCESSORI  
ACCESSORIES

TESTATE TERMINALI (2 pz.)

END CAPS (2 pcs)



108684.\_ \_ 01 02 20 21

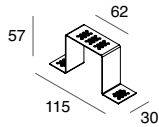

KIT INCASSO FRAMELESS (1 pz)

Per cartongesso H 12mm.

2 pz per profili lineari fino a L 2240mm,

3 pz per profili L 2520mm, 2800mm e profilo LED angolare 90°.

108688.99

KIT FRAMELESS RECESSED (1 pc)

For H 12mm plasterboard.

2 pcs for linear profiles up to L 2240mm,

3 pcs for profiles L 2520mm, 2800mm and for 90° corner LED profile.

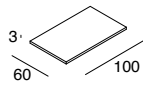

SPESSORE (2 pz)

Per cartongesso H 10mm. Inserire 2 pz in corrispondenza di ciascuna staffa da incasso.

108689.99

PLASTIC SPACER (2 pcs)

For H 10mm plasterboard. Put 2 pcs for each bracket for recessed installation.

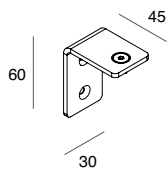

STAFFA PARETE (1 pz)

2 pz per profili lineari fino a L 2240mm,

3 pz per profili L 2520 mm e L 2800mm.



108687.\_ \_ 01 02 20 21

WALL BRACKET (1 pc)

2 pcs for linear profiles up to L 2240mm,

3 pcs for linear profiles L 2520mm and L 2800mm.



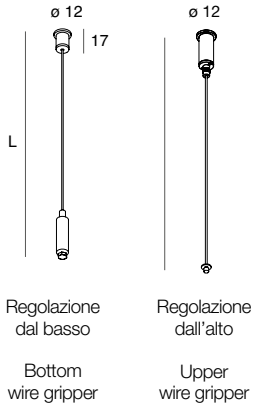

**CAVO DI SOSPENSIONE DI TESTA (1 pz)**  
 1 pz a inizio e fine linea continua e 2 pz per installazione singola. 1 pz aggiuntivo per fissaggio centrale dei profili L 2520 mm, L 2800 mm e profilo LED angolare 90°. In acciaio, regolabile. Non necessario per modulo cieco a L e lineare L.250mm.

**END LINE SUSPENSION CABLE (1 pc)**  
 1 pc for both ends of a continuous line and 2 pcs for stand alone installation. 1 pc more in the middle for profiles L 2520mm, L 2800mm and 90° corner LED profile. Not required for L blind module and linear L.250mm.

	L (mm)	VERSION
<b>108685.99</b>	3000	Regolazione dal basso / Bottom wire gripper
<b>1086A1.99</b>	3000	Regolazione dall'alto / Upper wire gripper

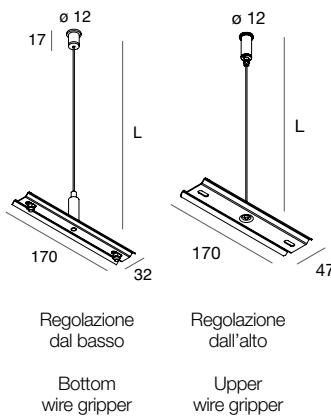

**CAVO DI SOSPENSIONE PER UNIONE PROFILI (1 pz)**  
 Obbligatorio per installazione in fila continua. In acciaio, regolabile. Non compatibile con moduli L 250mm o angolare cieco.

**SUSPENSION CABLE TO JOINT PROFILES (1 pc)**  
 Mandatory for installation in continuous line. Made of steel, adjustable. Not compatible with modules L 250mm or L blind module.

	L (mm)	VERSION
<b>108686.99</b>	3000	Regolazione dal basso / Bottom wire gripper
<b>1086A2.99</b>	3000	Regolazione dall'alto / Upper wire gripper

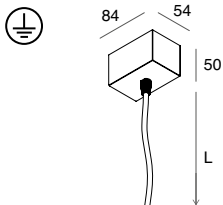

**KIT DI ALIMENTAZIONE**  
 Cavo con guaina trasparente

**POWER SUPPLY KIT**  
 Cable with transparent sheath

					L (mm)	Cavo / Cable (mm <sup>2</sup> )
<b>108919</b> ._._	<input type="checkbox"/> 01	<input type="checkbox"/> 02	<input type="checkbox"/> 20	<input type="checkbox"/> 21	1200	3x1,5
<b>108920</b> ._._	<input type="checkbox"/> 01	<input type="checkbox"/> 02	<input type="checkbox"/> 20	<input type="checkbox"/> 21	3000	3x1,5
<b>108921</b> ._._	<input type="checkbox"/> 01	<input type="checkbox"/> 02	<input type="checkbox"/> 20	<input type="checkbox"/> 21	1200	5x1,5
<b>108922</b> ._._	<input type="checkbox"/> 01	<input type="checkbox"/> 02	<input type="checkbox"/> 20	<input type="checkbox"/> 21	3000	5x1,5

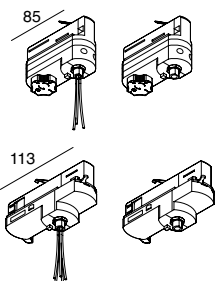

**COPPIA DI ADATTATORI PER BINARIO ALL-TRACK**

**COUPLE OF ADAPTORS FOR ALL-TRACK**

			VERSION
<b>106722</b> ._._	<input type="checkbox"/> 01	<input type="checkbox"/> 02	3P
<b>106723</b> ._._	<input type="checkbox"/> 01	<input type="checkbox"/> 02	3P + DALI