



HALOS SPOT

EMISSIONE DIRETTA

DIRECT EMISSION



Profilo LED circolare per installazione a sospensione, ad emissione diretta e completo di 3 proiettori LED orientabili. Doppia accensione per spot ed emissione diretta.
 Corpo in estruso di alluminio, rosoni in acciaio verniciato a polvere e schermo diffusore in PMMA opale. Proiettori in lega di alluminio pressofuso verniciato, provvisti di riflettore satinato nero in polimero tecnico. 4 cavi di acciaio di sospensione L.3000 mm e di cavo di alimentazione inclusi (4x0,5 mmq per bianco e nero o 4x0,75 mmq trasparente per gli altri colori).
 Disponibili rosoni con alimentazione integrata per cavi di sospensione convergenti o paralleli, oppure rosoni per alimentazione remota. Alimentazione elettronica 220-240V 50/60Hz disponibile anche dimmerabile DALI-PUSH.

Circular LED profile for suspension mounting, with direct light emission and complete with 3 adjustable LED spotlights. Double switch for spots and direct emission.
 Body made of extruded aluminium, canopies made of powder coated steel and PMMA opal diffuser. Spotlights made by painted die-cast aluminium alloy, with technical polymer black satin reflector.
 4 suspension steel cables L. 3000mm and power cable included (4x0,5 mmq for white and black or 4x0,75 mmq transparent for other colours). Canopies with integrated power supply or for remote power supply are available. Electronic driver 220-240V 50/60Hz are also available DALI-PUSH.

CEILING
SUSPENSION

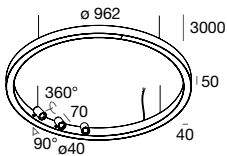

HALOS SPOT 962
EMISSIONE DIRETTA + 3 SPOT

HALOS SPOT 962
DIRECT EMISSION + 3 SPOTS

		2700K				3000K				4000K			
		□	■	■	■	□	■	■	■	□	■	■	■
		SPOT											
20°	80W	109701_	01	4643 lm	02	20	21	2927 lm	22	3703 lm	1425 lm		
40°	80W	109702_	01	4643 lm	02	20	21	2927 lm	22	3703 lm	1455 lm		
20°	80W	109703_	01	4859 lm	02	20	21	3182 lm	22	3875 lm	1425 lm		
40°	80W	109704_	01	4859 lm	02	20	21	3182 lm	22	3875 lm	1455 lm		
20°	80W	109705_	01	5246 lm	02	20	21	3307 lm	22	4185 lm	1581 lm		
40°	80W	109706_	01	5246 lm	02	20	21	3307 lm	22	4185 lm	1617 lm		

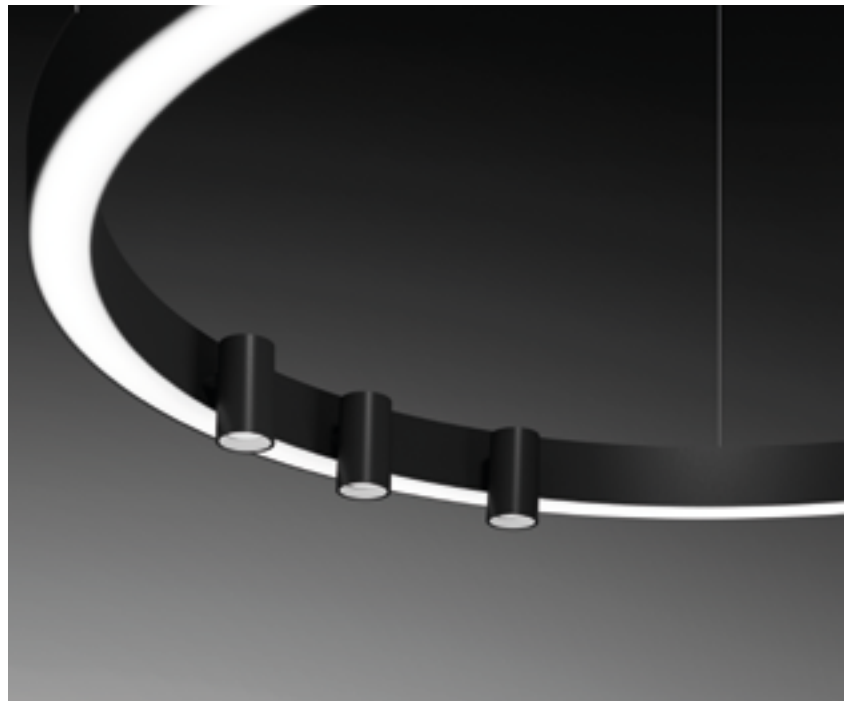



HALOS SPOT DIRETTA / DIRECT

ACCESSORI PER INSTALLAZIONE CON ALIMENTATORE REMOTO ACCESSORIES FOR REMOTE DRIVER MOUNTING



ROSONE PER
INSTALLAZIONE SINGOLA
ALIMENTAZIONE REMOTA
Coppia di alimentatori elettronici
da ordinare a parte.

105157_..	01	02	20	21	22

CANOPY FOR
SINGLE INSTALLATION
REMOTE DRIVER
Couple of electronic drivers
to be ordered separately.

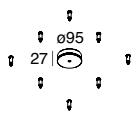

ROSONE PER
INSTALLAZIONE DOPPIA
ALIMENTAZIONE REMOTA
2 coppie di alimentatori elettronici
da ordinare a parte.

105158_..	01	02	20	21	22

CANOPY FOR
DOUBLE INSTALLATION
REMOTE DRIVER
2 couples of electronic drivers
to be ordered separately.

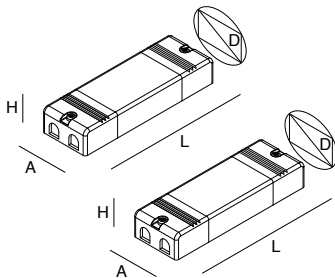

COPPIA DI ALIMENTATORI
ELETTRONICI
220-240V 50/60Hz
Doppia accensione per spot
ed emissione diretta.

	D (mm)	A (mm)	H (mm)	L (mm)
109713.99	105	100	31	235
	77	70	31	200

CUPLE OF ELECTRONIC DRIVERS
220-240V 50/60Hz
Double switch for spots
and direct emission.

DALI-PUSH

	D (mm)	A (mm)	H (mm)	L (mm)
109714.99	105	100	31	235
	77	70	31	200

HALOS SPOT DIRETTA / DIRECT

ACCESSORI PER INSTALLAZIONE CON ALIMENTATORE NEL ROSONE ACCESSORIES FOR INSTALLATION WITH DRIVER IN THE CANOPY

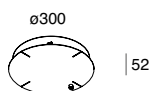

ROSONE PER CAVI CONVERGENTI
ALIMENTAZIONE INTEGRATA
Prevista accensione unica per
gestione PUSH

109715_..	01	02	20	21	22

CANOPY FOR CONVERGING
CABLES
INTEGRATED DRIVER
One switch for PUSH management

DALI-PUSH

109716_..	01	02	20	21	22

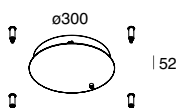

ROSONE PER CAVI PARALLELI
ALIMENTAZIONE INTEGRATA
Prevista accensione unica per
gestione PUSH

109717_..	01	02	20	21	22

CANOPY FOR PARALLEL CABLES
INTEGRATED DRIVER
One switch for PUSH management

DALI-PUSH

109718_..	01	02	20	21	22

HALOS SPOT

EMISSIONE INTERNA

INTERNAL EMISSION



Profilo LED circolare per installazione a sospensione, plafone o parete, ad emissione interna e completo di 3 proiettori LED orientabili. Doppia accensione per spot ed emissione interna.

Corpo in estruso di alluminio e rosconi in acciaio verniciato a polvere, schermo diffusore in PMMA opale. Proiettori in lega di alluminio pressofuso verniciati, provvisti di riflettore satinato nero in polimero tecnico.

Per installazione a plafone/parete prevedere alimentazione remota da ordinare a parte. Per installazione a sospensione prevedere rosconi con alimentazione integrata per cavi di sospensione convergenti o paralleli, oppure rosconi per alimentazione remota unitamente a kit di sospensione e cavo di alimentazione da ordinare a parte.

Alimentazione elettronica 220-240V 50/60Hz disponibile anche dimmerabile DALI-PUSH.

Circular LED profile for suspension, ceiling or wall mounting, with internal light emission and complete with 3 adjustable LED spotlights. Double switch for spots and internal emission.

Body made of extruded aluminium, canopies made of powder coated steel and PMMA opal diffuser.

Spotlights made by painted die-cast aluminium alloy, with technical polymer black satin reflector.

For ceiling/wall mounting it is required the remote electronic driver to be ordered separately.

For suspension mounting it is required the canopy with integrated driver, or remote driver and suspension cables and power cable, to be ordered separately.

Electronic driver 220-240V 50/60Hz is also available DALI-PUSH.

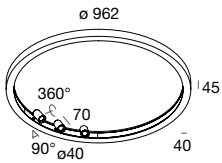

HALOS SPOT 962

EMISSIONE INTERNA + 3 SPOT

HALOS SPOT 962

INTERNAL EMISSION + 3 SPOTS

2700K

											SPOT
20°	70W	109707_..	01	2504 lm	02	20	21	1578 lm	22	1996 lm	1425 lm
40°	70W	109708_..	01	2504 lm	02	20	21	1578 lm	22	1996 lm	1455 lm

3000K

											SPOT
20°	70W	109709_..	01	2701 lm	02	20	21	1768 lm	22	2154 lm	1425 lm
40°	70W	109710_..	01	2701 lm	02	20	21	1768 lm	22	2154 lm	1455 lm

4000K

											SPOT
20°	70W	109711_..	01	2785 lm	02	20	21	1823 lm	22	2221 lm	1581 lm
40°	70W	109712_..	01	2785 lm	02	20	21	1823 lm	22	2221 lm	1617 lm



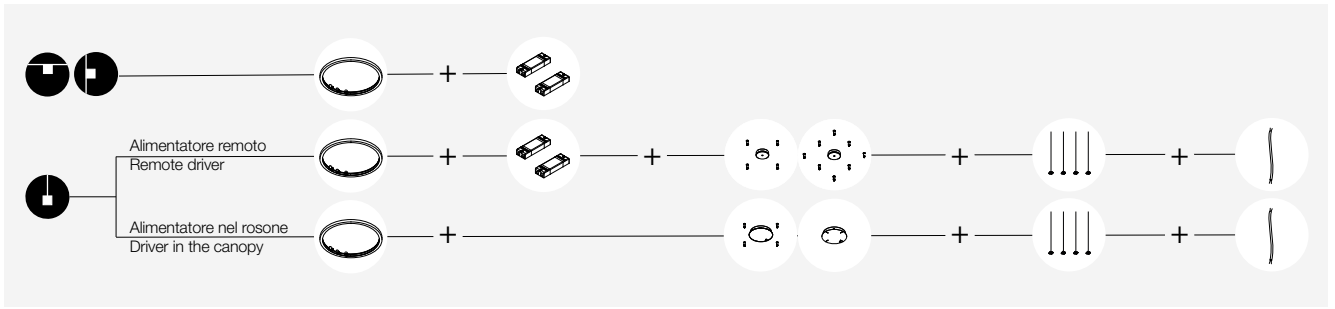

HALOS SPOT

ACCESSORI ACCESSORIES

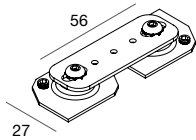

KIT DI GIUNZIONE MECCANICA
In acciaio verniciato.
Solo per installazione a sospensione

MECHANICAL JUNCTION KIT
In painted steel.
For suspension installation only.

109809._ 01 02

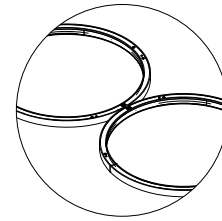

HALOS SPOT INTERNA / INTERNAL

ACCESSORI PER INSTALLAZIONE CON ALIMENTATORE NEL ROSONE ACCESSORIES FOR INSTALLATION WITH DRIVER IN THE CANOPY

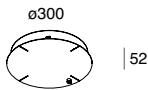

ROSONE PER CAVI CONVERGENTI
ALIMENTAZIONE INTEGRATA
kit sospensione e cavo di alimentazione
da ordinare a parte
Prevista accensione unica per gestione PUSH

CANOPY FOR CONVERGING CABLES
INTEGRATED DRIVER
Suspension kit, power cable driver to be
ordered separately.
One switch for PUSH management

109715._ 01 02 20 21 22

DALI-PUSH

109716._ 01 02 20 21 22

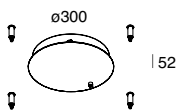

ROSONE PER CAVI PARALLELI
ALIMENTAZIONE INTEGRATA
Prevista accensione unica per gestione PUSH
Kit sospensione e cavo di alimentazione da
ordinare a parte

CANOPY FOR PARALLEL CABLES
INTEGRATED DRIVER
Suspension kit, power cable driver to be
ordered separately.
One switch for PUSH management

109717._ 01 02 20 21 22

DALI-PUSH

109718._ 01 02 20 21 22

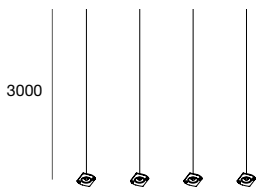

KIT SOSPENSIONE
SUSPENSION KIT

105159.99 L (mm) 3000

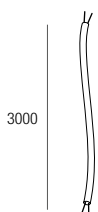

CAVO DI ALIMENTAZIONE
Trasparente, bianco o nero.
POWER CABLE
Transparent, white or black.

109002._ 00 01 02 L (mm) 3000

HALOS SPOT INTERNA / INTERNAL

ACCESSORI PER INSTALLAZIONE CON ALIMENTATORE REMOTO ACCESSORIES FOR INSTALLATION WITH REMOTE DRIVER



ROSONE PER INSTALLAZIONE SINGOLA
ALIMENTAZIONE REMOTA
Kit di sospensione, cavo di alimentazione
e coppia di alimentatori elettronici da ordinare
a parte.

CANOPY FOR SINGLE INSTALLATION
REMOTE DRIVER
Suspension kit, power cable and couple of
electronic drivers to be ordered separately.



105157... 01 02 20 21 22

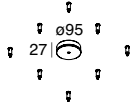

ROSONE PER INSTALLAZIONE DOPPIA
ALIMENTAZIONE REMOTA
2 kit di sospensione, 2 cavi di alimentazione
e 2 coppie di alimentatori elettronici
da ordinare a parte.

CANOPY FOR DOUBLE INSTALLATION
REMOTE DRIVER
2 Suspension kits, 2 power cables
and 2 couples of electronic drivers
to be ordered separately.



105158... 01 02 20 21 22

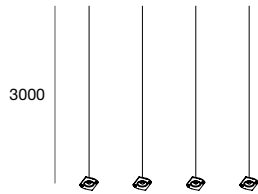

KIT SOSPENSIONE
SUSPENSION KIT

L (mm)

105159.99 3000

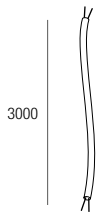

CAVO DI ALIMENTAZIONE
Trasparente, bianco o nero.

POWER CABLE
Transparent, white or black.



L (mm)

109002... 00 01 02 3000

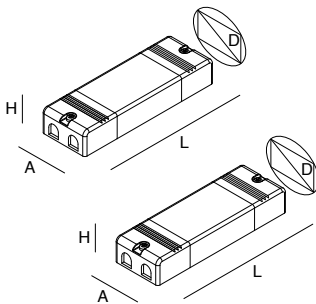

COPPIA DI ALIMENTATORI ELETTRONICI
220-240V 50/60Hz
Doppia accensione per spot
ed emissione interna.

COUPLE OF ELECTRONIC DRIVERS
220-240V 50/60Hz
Double switch for spots
and internal emission.

D (mm) A (mm) H (mm) L (mm)

109713.99 105 100 31 235
77 70 31 200

DALI-PUSH

D (mm) A (mm) H (mm) L (mm)

109714.99 105 100 31 235
77 70 31 200