

CAOS: ESEMPI DI COMPOSIZIONI | COMPOSITION EXAMPLES

Associare moduli elettrificati con numero di driver pari ai Moduli LED, secondo tabella (codici on-off)
 Match electrified modules with a number of drivers equal to the LED Modules, according to the table (on-off codes)

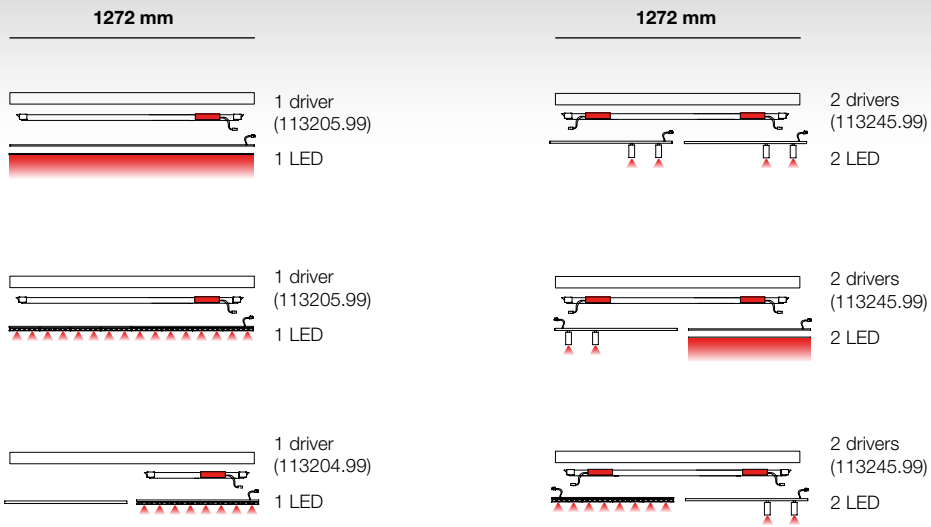

LEGENDA | LEGEND

Moduli elettrificati (codici on-off)
 Driver Modules (on-off codes)

N. DRIVERS	636 mm	1272 mm
1		
2		

- Mod. LED + Schermo op.
LED Module + Opal screen
- Mod. LED Micro ottiche
Micro-optics LED Module
- Mod. Spot Klimt
Spot Klimt Module
- Cover cieca
Blind Cover

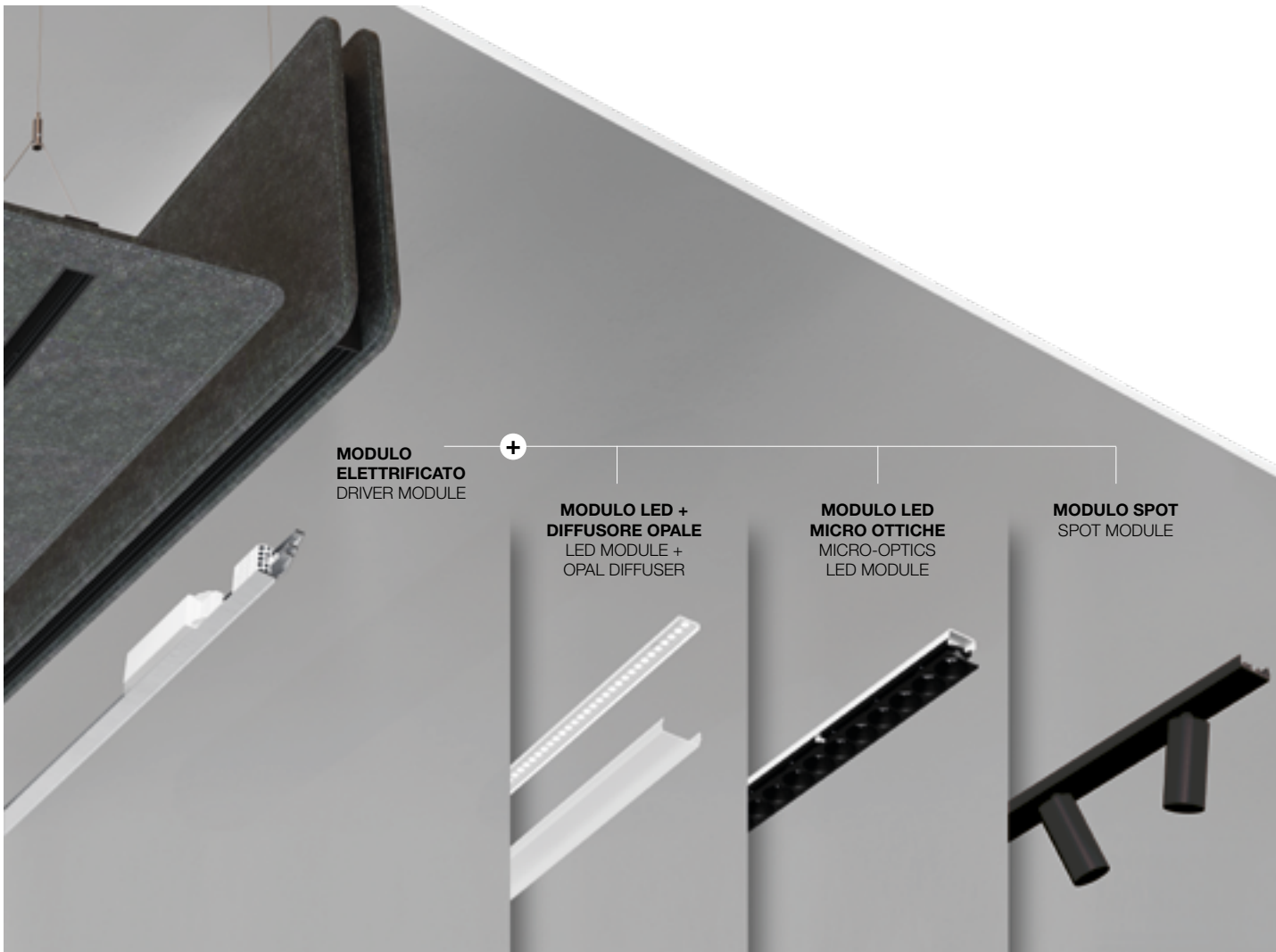

MODULO ELETRIFICATO
DRIVER MODULE



MODULO LED + DIFFUSORE OPALE
LED MODULE + OPAL DIFFUSER

MODULO LED MICRO OTTICHE
MICRO-OPTICS LED MODULE

MODULO SPOT
SPOT MODULE

NEW CAOS

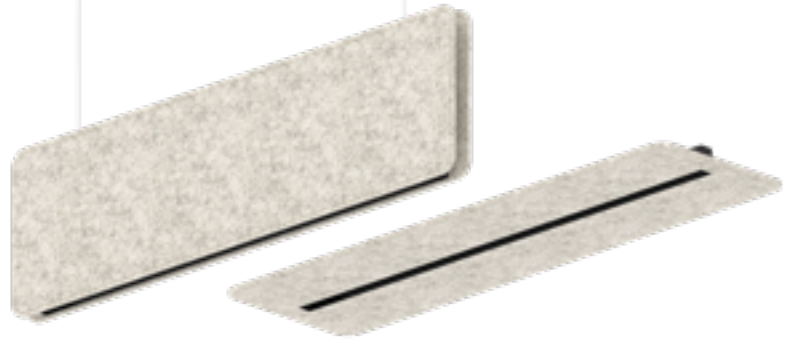
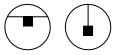

Apparecchio LED ad emissione diretta, provvisto di pannello fonoassorbente in feltro PET riciclato con bordatura estetica in filato. Versione verticale installabile a sospensione; versione orizzontale installabile a plafone o a sospensione. Pannello disponibile in quattro finiture materiche: Carbone, Comfort Grey e Lime con bordatura grigia, Sabbia con bordatura ocra. Colorazioni differenti disponibili su richiesta. Telaio in acciaio verniciato a polvere e profilo in lega di alluminio nera predisposto per l'alloggiamento dei moduli elettrificati on-off o DALI/PUSH, e dei moduli luminosi: moduli LED con diffusore opale - moduli LED micro ottiche - moduli spot LED.

Direct emission LED fixture equipped with a sound-absorbing panel in recycled PET felt with a decorative stitched border. Vertical version suitable for suspension installation; horizontal version suitable for ceiling-mounted or suspension installation. The panel is available in four material finishes: Charcoal, Comfort Grey, and Lime with a grey stitching, and Sand with an ochre stitching. Custom colors available upon request. Powder-coated steel frame and black aluminum alloy profile, designed to accommodate electrified modules (ON/OFF or DALI/PUSH) and lighting modules: LED modules with opal diffuser, LED modules with micro optics, and LED spot modules.

ACOUSTIC

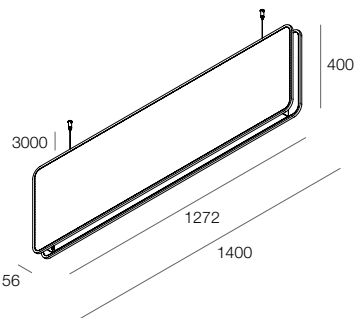
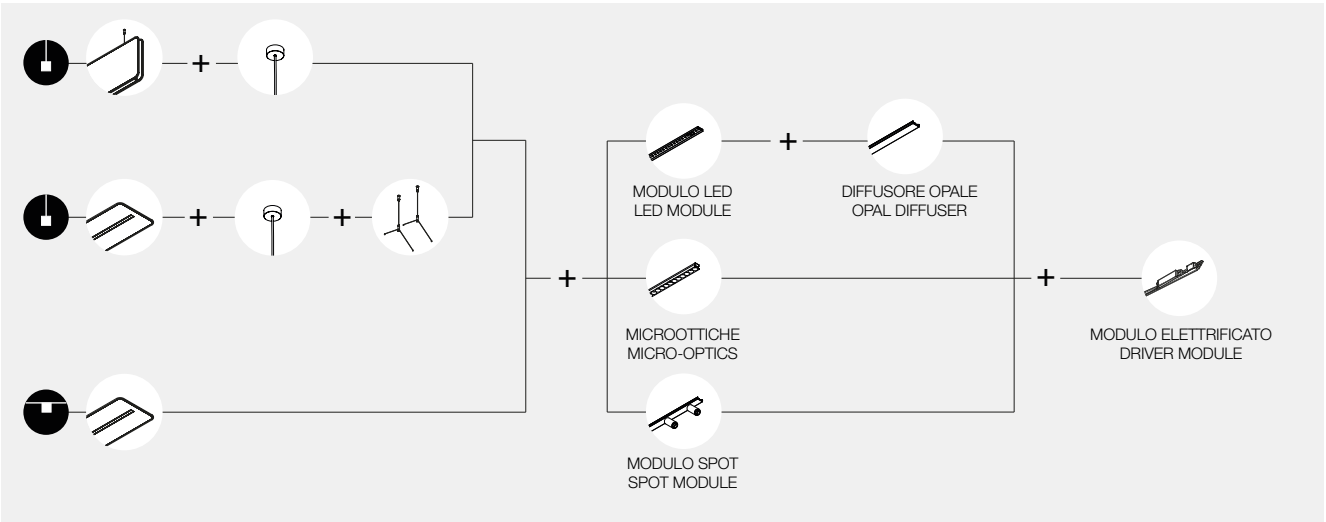

CAOS VERTICALE

Cavi di sospensione inclusi. Modulo LED, Modulo elettrificato e kit di alimentazione da ordinare a parte.

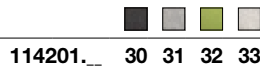

CAOS VERTICAL

Suspension cables included. LED module, Driver module and power supply kit to be ordered separately.

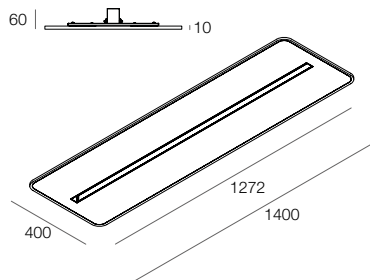

CAOS ORIZZONTALE

Modulo LED, Modulo elettrificato, kit di alimentazione e cavi di sospensione da ordinare a parte. Installabile a plafone senza accessori aggiuntivi.

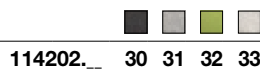

CAOS HORIZONTAL

LED module, Driver module, power supply kit and suspension cables to be ordered separately. Ceiling-mountable without additional accessories.

CAOS

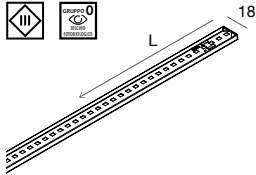
MODULI LED
LED MODULESVedi schemi per combinazioni di più Moduli LED
See diagrams for multiple LED Module combinations**MODULO LED
PER DIFFUSORE OPALE**Connettore rapido per modulo
elettrificato incluso. Diffusore opale
da ordinare a parte.

L (mm)

636	12W	2700K	113214.99
636	12W	3000K	113215.99
636	12W	4000K	113216.99
1272	24W	2700K	113217.99
1272	24W	3000K	113218.99
1272	24W	4000K	113219.99

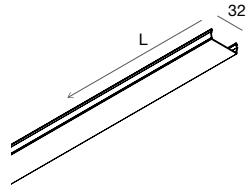
**LED MODULE
FOR OPAL DIFFUSER**Quick connector to the driver module
included. Opal diffuser to be ordered
separately.DIFFUSORE OPALE
Schermo ad incastro a filo.

L (mm)

	2700K	3000K	4000K	
636	930 lm	951 lm	1051 lm	113229.99
1272	1861 lm	1903 lm	2103 lm	113230.99

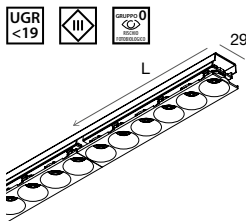
OPAL DIFFUSER
Flush screen.**MODULO LED MICRO OTTICHE**Riflettore in PC nero finitura matt, lenti in
PMMA e connettore rapido per modulo
elettrificato inclusi.

L (mm)

636	17W	40°	2700K	1708 lm	113211.02
636	17W	40°	3000K	1798 lm	113212.02
636	17W	40°	4000K	1893 lm	113213.02
1272	34W	40°	2700K	3416 lm	113242.02
1272	34W	40°	3000K	3596 lm	113243.02
1272	34W	40°	4000K	3786 lm	113244.02

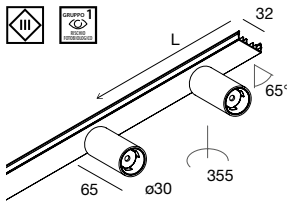
MICRO-OPTICS LED MODULEMatt finish black PC reflector, PMMA
lenses and quick connector for the
driver module included.**MODULO SPOT LED KLIMT**Cover con 2 proiettori in lega di
alluminio pressofuso verniciato a polvere
con lenti in policarbonato. Connettore
rapido per modulo elettrificato incluso.

L (mm)

636	2x4W	25°	2700K	670 lm	113223.02
636	2x4W	25°	3000K	716 lm	113224.02
636	2x4W	25°	4000K	771 lm	113225.02
636	2x4W	45°	2700K	730 lm	113226.02
636	2x4W	45°	3000K	779 lm	113227.02
636	2x4W	45°	4000K	837 lm	113228.02

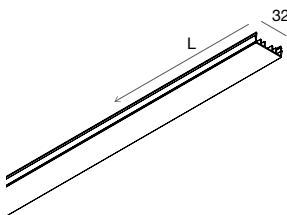
KLIMT LED SPOT MODULECover with 2 projectors in die-cast
aluminum, powder-coated, with
polycarbonate lenses. Quick connector
for the driver module included.**COVER CIECA**In estruso di alluminio verniciato a
polvere, provvista di cablaggio passante.

L (mm)

636	113233.02
-----	------------------

BLIND COVER
Extruded powder-coated aluminium,
provided with through wiring.

CAOS

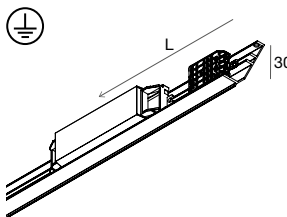
MODULO ELETRIFICATO
DRIVER MODULEVedi schemi per combinazioni di più Moduli LED
See diagrams for multiple LED Module combinations**MODULO ELETRIFICATO**Alimentazione elettronica, connettore
rapido per Moduli LED e cablaggio
passante inclusi.

L (mm)

	1 driver	2 drivers
636	113204.99	-
1272	113205.99	113245.99

DRIVER MODULEElectronic driver, quick connector
for LED Modules and through wiring
included.**DALI-PUSH**

L (mm)

	1 driver	2 drivers
636	113248.99	-
1272	113249.99	113251.99

EMERGENCY 1 H Flusso in emergenza 17% / Emergency flux 17%

L (mm)

1272	113254.99
------	------------------

Autonomia 1h / Ricarica 12h
Autonomy 1h / Charging 12h

CAOS

ACCESSORI
ACCESSORIES

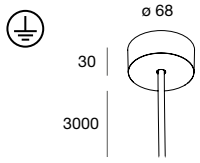

KIT DI ALIMENTAZIONE PER SOSPENSIONE
ROSONE CIRCOLARE
Cavo con guaina trasparente.

POWER SUPPLY KIT FOR SUSPENSION
ROUND CANOPY
Cable with transparent sheath.

	□	■	L (mm)	Cavo / Cable (mm ²)
109005. __	01	02	3000	3x1,5
109007. __	01	02	3000	5x1,5

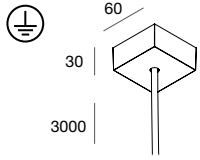

KIT DI ALIMENTAZIONE PER SOSPENSIONE
ROSONE QUADRATO
Cavo con guaina trasparente.

POWER SUPPLY KIT FOR SUSPENSION
SQUARE CANOPY
Cable with transparent sheath.

	□	■	L (mm)	Cavo / Cable (mm ²)
109006. __	01	02	3000	3x1,5
109008. __	01	02	3000	5x1,5

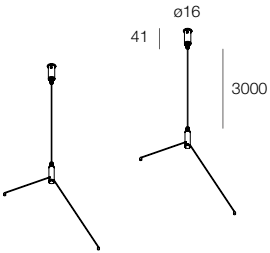

CAVI DI SOSPENSIONE (2 pz)
Solo per versione orizzontale.

SUSPENSION CABLES (2 pcs)
Only for horizontal version.

	L (mm)
114205. __	3000

