

## CAOS B: ESEMPI DI COMPOSIZIONI | COMPOSITION EXAMPLES

Associare moduli elettrificati con numero di driver pari ai Moduli LED, secondo tabella (codici on-off)  
 Match electrified modules with a number of drivers equal to the LED Modules, according to the table (on-off codes)

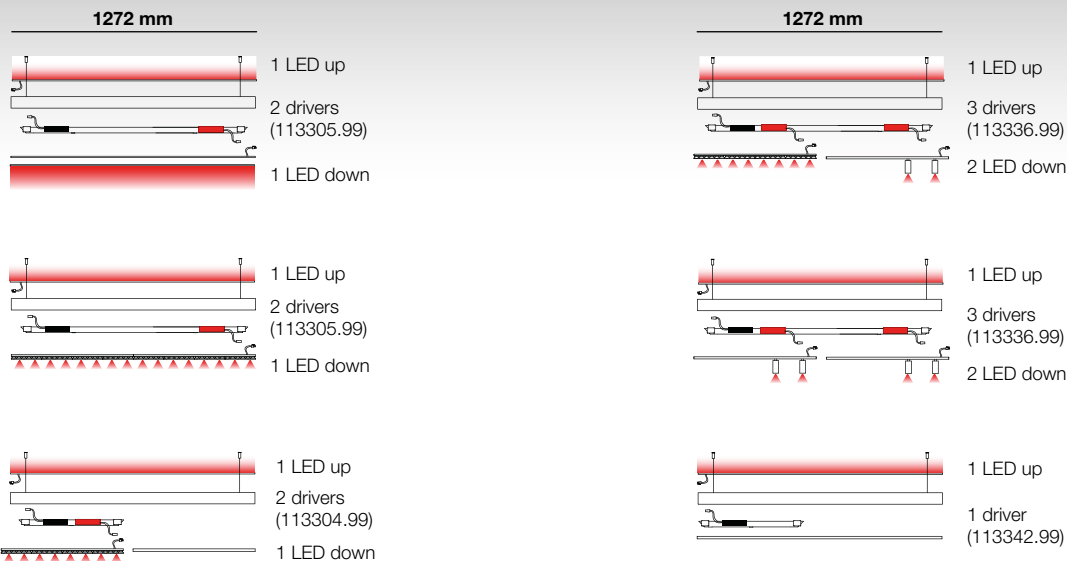

### LEGENDA | LEGEND

Moduli elettrificati (codici on-off)  
 Driver Modules (on-off codes)

N. DRIVERS	636 mm	1272 mm
1 up 1 down		
1 up 2 down		
1 up		

- Mod. LED + Schermo op.  
LED Module + Opal screen
- Mod. LED Micro ottiche  
Micro-optics LED Module
- Mod. Spot Klimt  
Spot Klimt Module
- Mod. LED indiretto  
Indirect LED Module
- Cover cieca  
Blind Cover

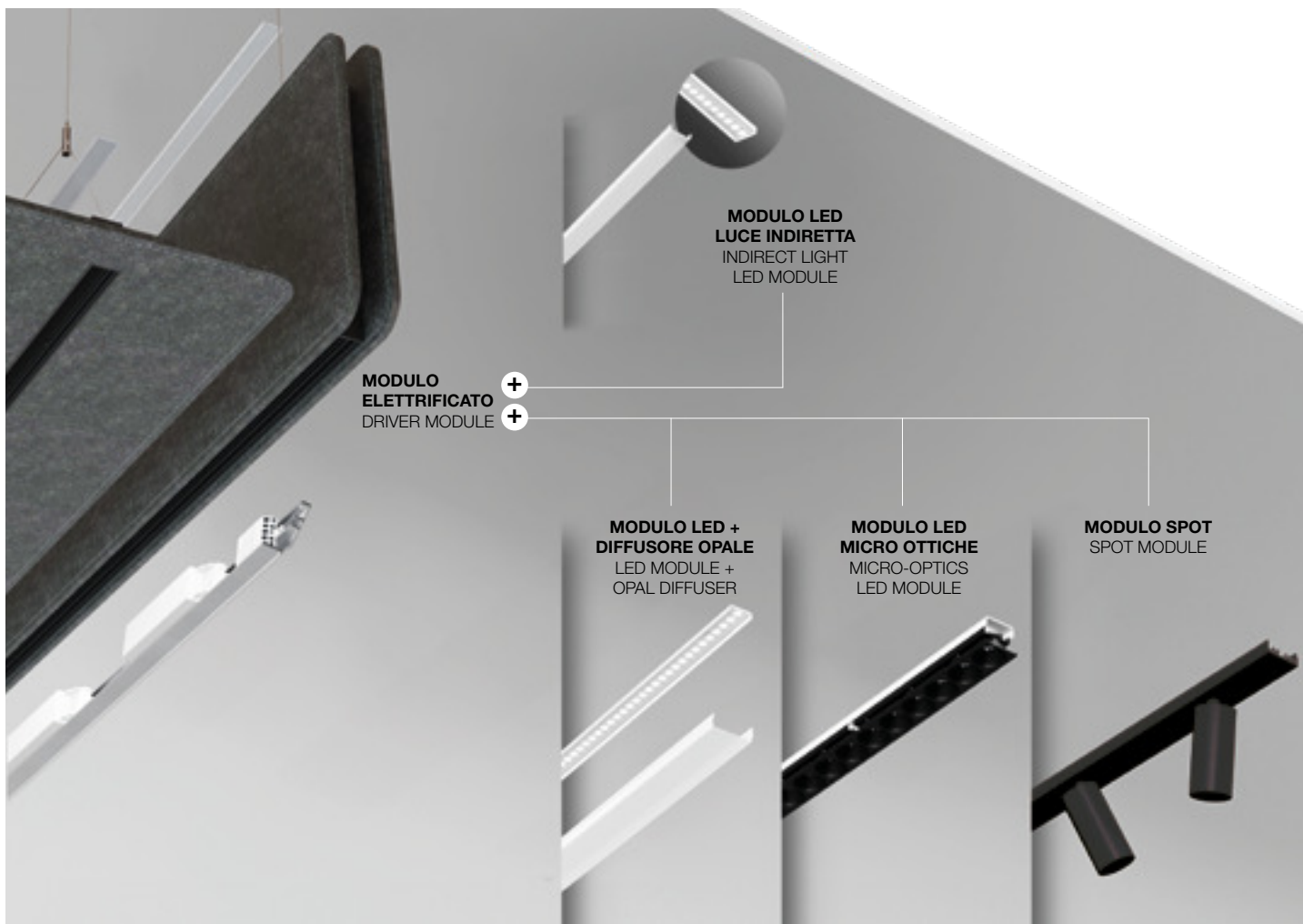

**NEW CAOS B**



Apparecchio LED biemissione per installazione a sospensione, provvisto di pannello fonoassorbente in feltro PET riciclato con bordatura estetica in filato. Pannello disponibile in quattro finiture materiche: Carbone, Comfort Grey e Lime con bordatura grigia, Sabbia con bordatura ocra. Colorazioni differenti disponibili su richiesta. Telaio in acciaio verniciato a polvere e profilo in lega di alluminio nera predisposto per l'alloggiamento dei moduli elettrificati on-off o DALI/PUSH, e dei moduli luminosi: moduli LED con diffusore opale (diretti e indiretti) - moduli LED micro ottiche - moduli spot LED.

Double-emission LED fixture for suspension installation, equipped with a sound-absorbing panel made of recycled PET felt with a decorative stitched edging. The panel is available in four material finishes: Charcoal, Comfort Grey, and Lime with a grey stitching, and Sand with an ochre stitching. Other colors available upon request. Powder-coated steel frame and black aluminum alloy profile designed to house on-off or DALI/PUSH driver modules, as well as lighting modules: LED modules with opal diffuser (direct and indirect output) - LED micro-optic modules - LED spot modules.



ACOUSTIC

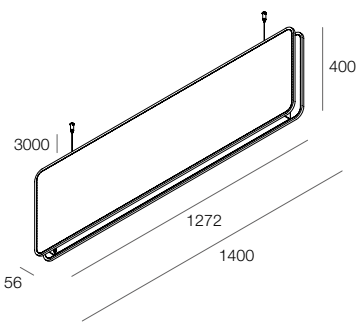
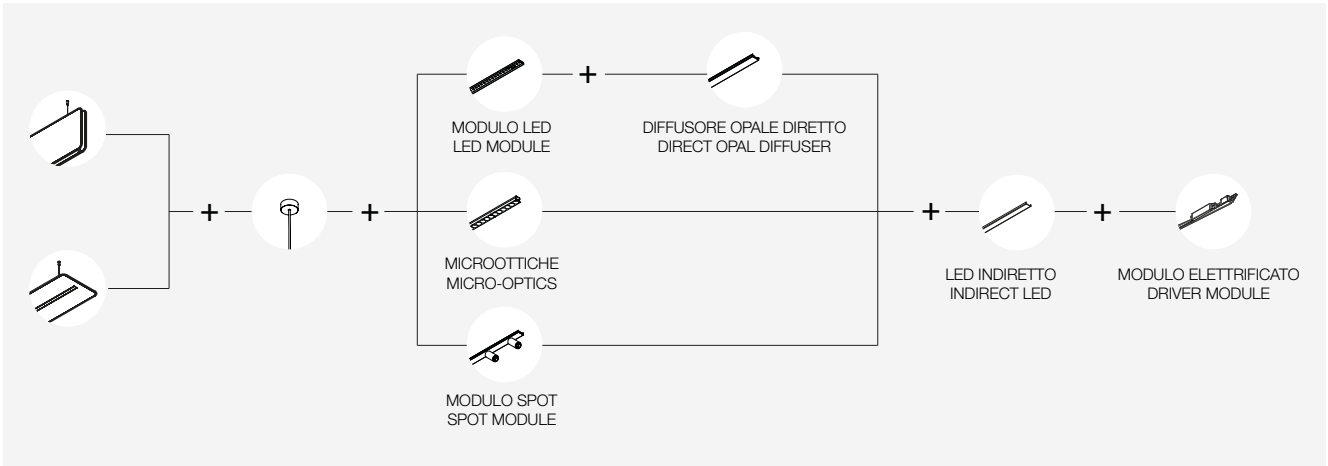

**CAOS B VERTICALE**

Completo di diffusore opale indiretto e 2 cavi di sospensione in acciaio con regolazione dall'alto. Moduli LED diretti e indiretti, Moduli elettrificati e kit di alimentazione da ordinare a parte.

**CAOS B VERTICAL**

Complete with indirect opal diffuser and 2 steel suspension cables with top adjustment. Direct and indirect LED Modules, Driver Modules and power supply kit to be ordered separately.



114203... 30 31 32 33

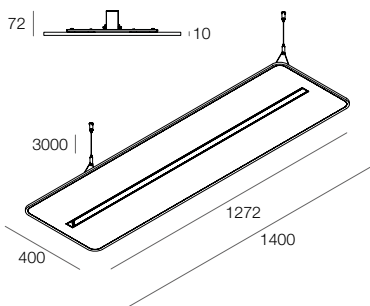

**CAOS B ORIZZONTALE**

Completo di diffusore opale indiretto e 2 cavi di sospensione in acciaio con regolazione dall'alto. Moduli LED diretti e indiretti, Moduli elettrificati e kit di alimentazione da ordinare a parte.

**CAOS B HORIZONTAL**

Complete with indirect opal diffuser and 2 steel suspension cables with top adjustment. Direct and indirect LED Modules, Driver Modules and power supply kit to be ordered separately.



114204... 30 31 32 33

## CAOS B

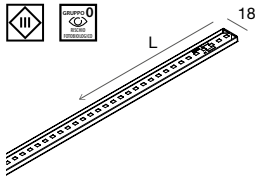
MODULI LED EMISSIONE DIRETTA  
DIRECT EMISSION LED MODULESVedi schemi per combinazioni di più Moduli LED  
See diagrams for multiple LED Module combinations**MODULO LED  
PER DIFFUSORE OPALE**Connettore rapido per modulo  
elettrificato incluso. Diffusore opale  
da ordinare a parte.

L (mm)

636	12W	2700K		<b>113214.99</b>
636	12W	3000K		<b>113215.99</b>
636	12W	4000K		<b>113216.99</b>
1272	24W	2700K		<b>113217.99</b>
1272	24W	3000K		<b>113218.99</b>
1272	24W	4000K		<b>113219.99</b>

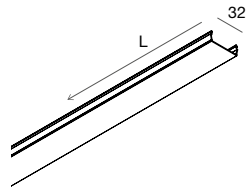
**LED MODULE  
FOR OPAL DIFFUSER**Quick connector to the driver module  
included. Opal diffuser to be ordered  
separately.DIFFUSORE OPALE  
Schermo ad incastro a filo.

L (mm)

		2700K	3000K	4000K	
636		930 lm	951 lm	1051 lm	<b>113229.99</b>
1272		1861 lm	1903 lm	2103 lm	<b>113230.99</b>

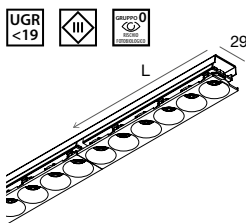
OPAL DIFFUSER  
Flush screen.**MODULO LED MICRO OTTICHE**Riflettore in PC nero finitura matt, lenti in  
PMMA e connettore rapido per modulo  
elettrificato inclusi.

L (mm)

636	17W	40°	2700K	1708 lm	<b>113211.02</b>
636	17W	40°	3000K	1798 lm	<b>113212.02</b>
636	17W	40°	4000K	1893 lm	<b>113213.02</b>
1272	34W	40°	2700K	3416 lm	<b>113242.02</b>
1272	34W	40°	3000K	3596 lm	<b>113243.02</b>
1272	34W	40°	4000K	3786 lm	<b>113244.02</b>

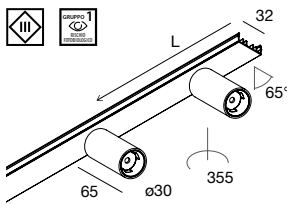
**MICRO-OPTICS LED MODULE**Matt finish black PC reflector, PMMA  
lenses and quick connector for the  
driver module included.**MODULO SPOT LED KLIMT**Cover con 2 proiettori in lega di  
alluminio pressofuso verniciato a polvere  
con lenti in policarbonato. Connettore  
rapido per modulo elettrificato incluso.

L (mm)

636	2x4W	25°	2700K	670 lm	<b>113223.02</b>
636	2x4W	25°	3000K	716 lm	<b>113224.02</b>
636	2x4W	25°	4000K	771 lm	<b>113225.02</b>
636	2x4W	45°	2700K	730 lm	<b>113226.02</b>
636	2x4W	45°	3000K	779 lm	<b>113227.02</b>
636	2x4W	45°	4000K	837 lm	<b>113228.02</b>

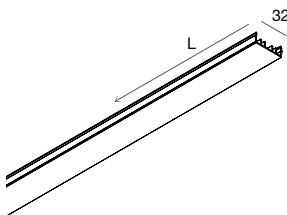
**KLIMT LED SPOT MODULE**Cover with 2 projectors in die-cast  
aluminum, powder-coated, with  
polycarbonate lenses. Quick connector  
for the driver module included.

## COVER CIECA

In estruso di alluminio verniciato a  
polvere, provvista di cablaggio passante.

L (mm)

636					<b>113233.02</b>
-----	--	--	--	--	------------------

BLIND COVER  
Extruded powder-coated aluminium,  
provided with through wiring.

## CAOS B

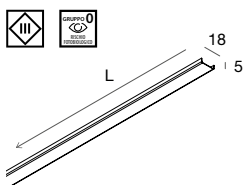
MODULI LED EMISSIONE INDIRETTA  
LED MODULES INDIRECT EMISSION**MODULO LED  
EMISSIONE INDIRETTA**Connettore rapido per modulo elettrificato  
incluso. Non abbinabile a cover cieca.

L (mm)

954	18W	2700K	1989 lm	<b>114206.99</b>
954	18W	3000K	2094 lm	<b>114207.99</b>
954	18W	4000K	2205 lm	<b>114208.99</b>

**LED MODULE  
INDIRECT EMISSION**Quick connector for driver module included.  
Cannot be combined with blind cover.

# CAOS B

## MODULO ELETRIFICATO DRIVER MODULE

Vedi schemi per combinazioni di più Moduli LED  
See diagrams for multiple LED Module combinations

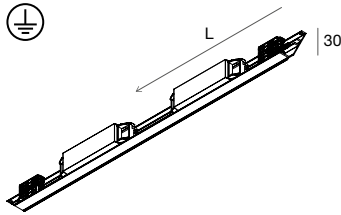

### MODULO ELETRIFICATO

Alimentazione elettronica per accensioni separate, connettori rapidi per Moduli LED emissione diretta ed indiretta e cablaggio passante inclusi.

### DRIVER MODULE

Electronic driver for separate switches, quick connectors for direct and indirect emission LED modules and through wiring included.

L (mm)	1 driver up 1 driver down	1 driver up 2 drivers down	1 driver up
636	<b>113304.99</b>	-	<b>113342.99</b>
1272	<b>113305.99</b>	<b>113336.99</b>	-
<b>DALI-PUSH</b>			
L (mm)	1 driver up 1 driver down	1 driver up 2 drivers down	1 driver up
636	<b>113307.99</b>	-	<b>113343.99</b>
1272	<b>113308.99</b>	<b>113339.99</b>	-

ACOUSTIC

# CAOS B

## ACCESSORI ACCESSORIES

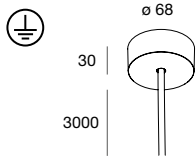

KIT DI ALIMENTAZIONE PER SOSPENSIONE  
ROSONE CIRCOLARE  
Cavo con guaina trasparente.

POWER SUPPLY KIT FOR SUSPENSION  
ROUND CANOPY  
Cable with transparent sheath.

	□	■	L (mm)	Cavo / Cable (mm <sup>2</sup> )
<b>109005</b> ._..	<b>01</b>	<b>02</b>	3000	3x1,5
<b>109007</b> ._..	<b>01</b>	<b>02</b>	3000	5x1,5

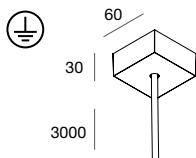

KIT DI ALIMENTAZIONE PER SOSPENSIONE  
ROSONE QUADRATO  
Cavo con guaina trasparente.

POWER SUPPLY KIT FOR SUSPENSION  
SQUARE CANOPY  
Cable with transparent sheath.

	□	■	L (mm)	Cavo / Cable (mm <sup>2</sup> )
<b>109006</b> ._..	<b>01</b>	<b>02</b>	3000	3x1,5
<b>109008</b> ._..	<b>01</b>	<b>02</b>	3000	5x1,5