





DOMYNOS PS

DOMYNOS PS crea un dialogo delicato con lo spazio che illumina. Uno speciale sistema di illuminazione Novalux con cui, combinando pochi moduli base, si aprono infinite possibilità di composizioni modulari, curvilinee o lineari. Disponibile nelle finiture in vernice bianca, nera, caffè o cappuccino. DOMYNOS PS è un prodotto di illuminazione Novalux che si contraddistingue per leggerezza ed eleganza: la sinuosità delle sue curve abbraccia con raffinatezza grandi e piccoli ambienti, rendendoli unici.

DOMYNOS PS creates a delicate dialogue with the space it illuminates. A special Novalux lighting system with which, combining a few basic modules, open up endless possibilities of modular, curvilinear or linear compositions. Available in white, black, coffee or cappuccino finishes. DOMYNOS PS is a Novalux lighting product that stands out for its lightness and elegance: the sinuosity of its curves embraces with refinement large and small environments, making them unique.

DOMYNOS PS

- **SISTEMA COMPONIBILE A PLAFONE, PARETE O SOSPENSIONE CON MODULI CURVI E LINEARI**

MODULAR CEILING, WALL OR SUSPENSION SYSTEM WITH CURVED AND LINEAR MODULES

- **DIVERSE SOLUZIONI PER LA CONNESSIONE ELETTRICA: KIT LINEARI O TONDI, A INIZIO LINEA O CENTRALI**

VARIOUS SOLUTIONS FOR THE ELECTRICAL CONNECTION: LINEAR OR ROUND KITS, AT THE BEGINNING OF THE LINE OR CENTRAL

- **MODULI LED 48V CON CONNETTORI RAPIDI PER FILA CONTINUA E AGGANCI PLASTICI PER IL MONTAGGIO SUL PROFILO**

48V LED MODULES EQUIPPED WITH QUICK CONNECTORS FOR CONTINUOUS LINE AND PLASTIC HOOKS FOR MOUNTING ON THE PROFILE

- **SCHERMO OPALE DA 6 METRI CURVABILE E TAGLIABILE IN OPERA**

BENDABLE 6 METERS OPAL DIFFUSER THAT CAN BE CUT ON SITE

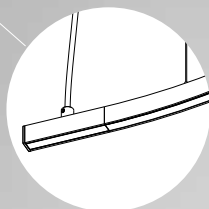
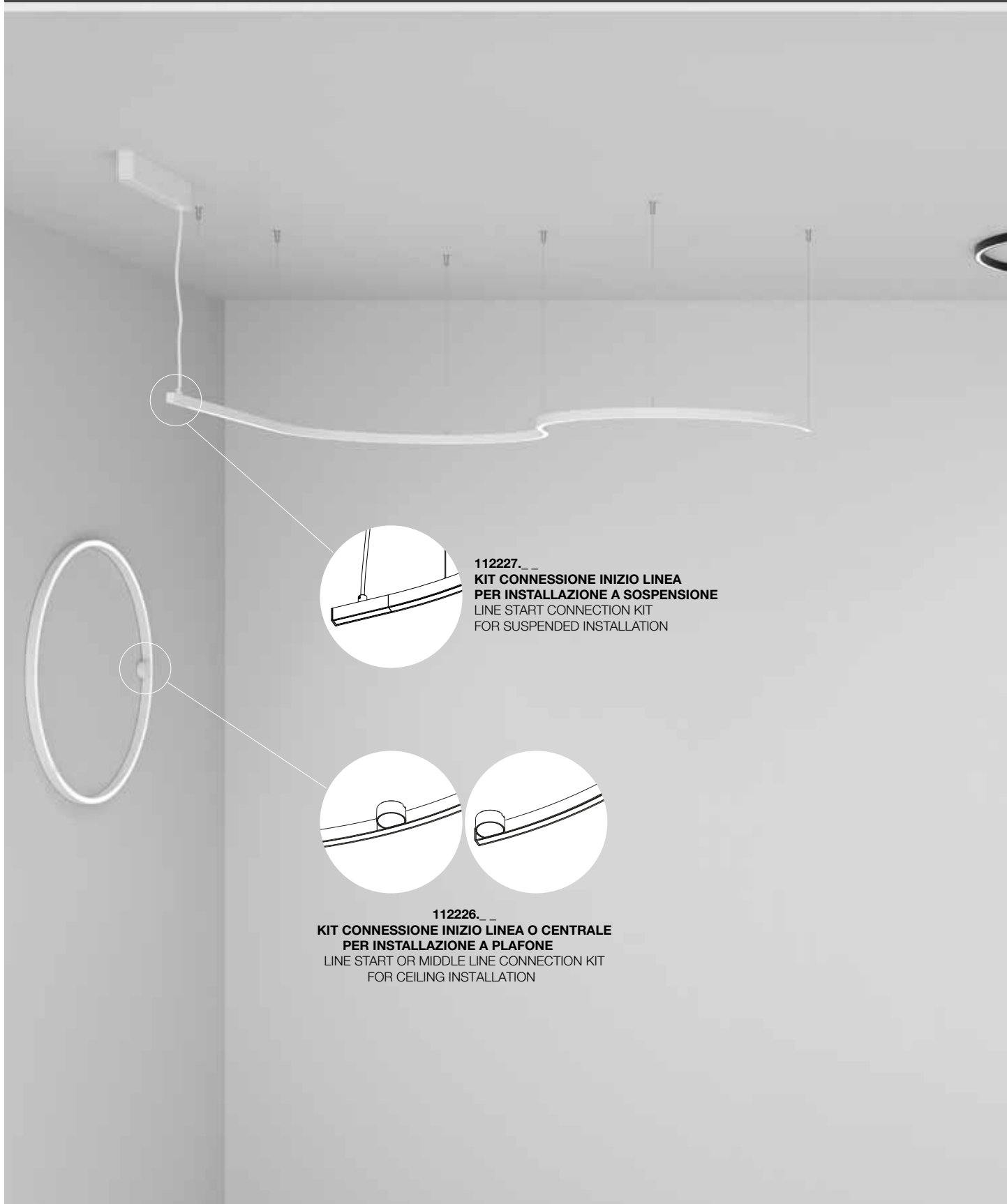

112227._._
**KIT CONNESSIONE INIZIO LINEA
 PER INSTALLAZIONE A SOSPENSIONE**
 LINE START CONNECTION KIT
 FOR SUSPENDED INSTALLATION

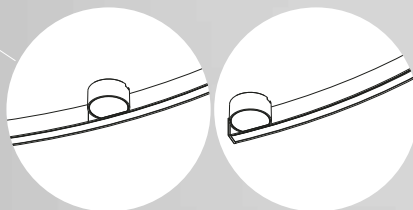

112226._._
**KIT CONNESSIONE INIZIO LINEA O CENTRALE
 PER INSTALLAZIONE A PLAFONE**
 LINE START OR MIDDLE LINE CONNECTION KIT
 FOR CEILING INSTALLATION

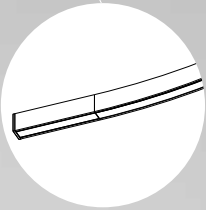
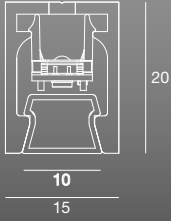

112225._ _
**KIT CONNESSIONE INIZIO LINEA
PER INSTALLAZIONE A PLAFONE**
LINE START CONNECTION KIT
FOR CEILING INSTALLATION

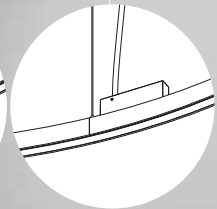
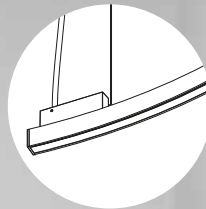

112228._ _
**KIT CONNESSIONE INIZIO LINEA O CENTRALE
PER INSTALLAZIONE A SOSPENSIONE**
LINE START OR MIDDLE LINE CONNECTION KIT
FOR SUSPENDED INSTALLATION

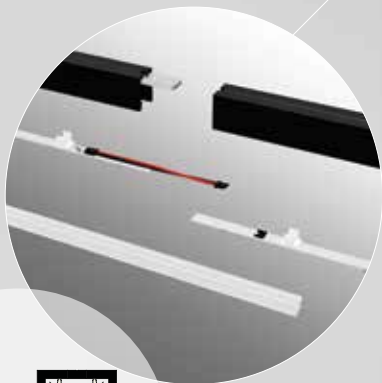

GIUNZIONE PROFILI
PROFILES JUNCTION

**BASE LED CON AGGANCI
E CONNETTORE RAPIDO**
LED BASE WITH HOOKS
AND QUICK CONNECTOR

SCHERMO OPALE 6M
CURVABILE E TAGLIABILE
OPAL DIFFUSER 6M
BENDABLE AND CAN BE CUT

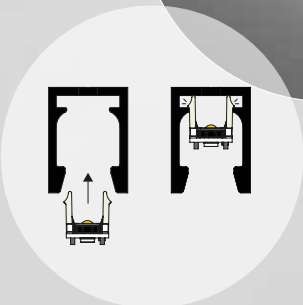

**AGGANCIO A SCATTO
DELLA BASE LED SU PROFILO**
SNAP-ON LED BASE ON PROFILE



DOMYNOS PS

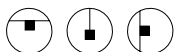

Sistema componibile a plafone, parete o sospensione con profilo in estruso di alluminio per l'alloggiamento di moduli LED 48V. Alimentazione 48V da remotizzare (ON/OFF o dimmerabile tramite interfacce di dimmerazione) o box con alimentazione integrata 48V ON/OFF o dimmerabile, per composizioni a sospensione.

Modular ceiling, wall or suspension system with extruded aluminium profile for housing 48V LED modules. Remote 48V driver (ON/OFF or dimmable via dimming interfaces) or box with integrated driver 48V, ON/OFF or dimmable, for suspended compositions.

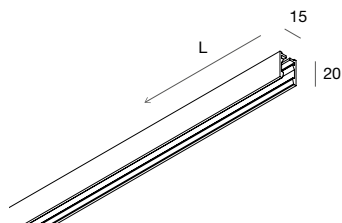

PROFILO LINEARE

Per moduli LED lineari L=498mm. Kit di giunzione incluso, schermo opale da ordinare a parte.

LINEAR PROFILE

For linear LED modules L=498mm. Junction kit included, opal diffuser shade to be ordered separately.

					L (mm)	n° LED modules
112201._	01	02	20	21	498	1
112202._	01	02	20	21	996	2
112203._	01	02	20	21	1992	4

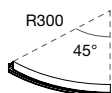

PROFILO CURVO R300 45°

Per modulo LED R300 45°. Kit di giunzione incluso, schermo opale da ordinare a parte. Non installabile a sospensione stand alone.

CURVED R300 45° PROFILE

For LED modules R300 45°. Junction kit included, opal diffuser shade to be ordered separately. Not installable in stand alone suspension.

					L (mm)	R (mm)	n° LED modules
112204._	01	02	20	21	249	300	1

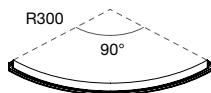

PROFILO CURVO R300 90°

Per modulo LED R300 90°. Kit di giunzione incluso, schermo opale da ordinare a parte. Non installabile a sospensione stand alone.

CURVED R300 90° PROFILE

For LED modules R300 90°. Junction kit included, opal diffuser shade to be ordered separately. Not installable in stand alone suspension.

					L (mm)	R (mm)	n° LED modules
112205._	01	02	20	21	498	300	1

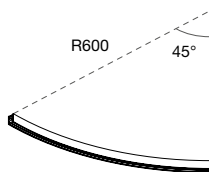

PROFILO CURVO R600 45°

Per modulo LED R600 45°. Kit di giunzione incluso, schermo opale da ordinare a parte. Non installabile a sospensione stand alone.

CURVED R600 45° PROFILE

For LED modules R600 45°. Junction kit included, opal diffuser shade to be ordered separately. Not installable in stand alone suspension.

					L (mm)	R (mm)	n° LED modules
112206._	01	02	20	21	498	600	1

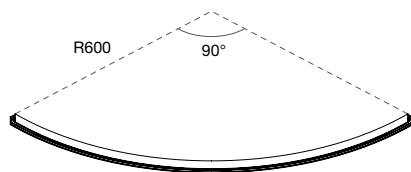

PROFILO CURVO R600 90°

Per modulo LED R600 90°. Kit di giunzione incluso, schermo opale da ordinare a parte.

CURVED R600 90° PROFILE

For LED modules R600 90°. Junction kit included, opal diffuser shade to be ordered separately.

					L (mm)	R (mm)	n° LED modules
112207._	01	02	20	21	996	600	1

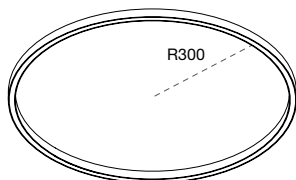

PROFILO CIRCOLARE R300

Per 4 moduli LED R300 90°. Schermo opale incluso.

CIRCULAR R300 PROFILE

For 4 LED modules R300 90°. Opal diffuser shade included.

					L (mm)	R (mm)	n° LED modules
112208._	01	02	20	21	1992	300	4

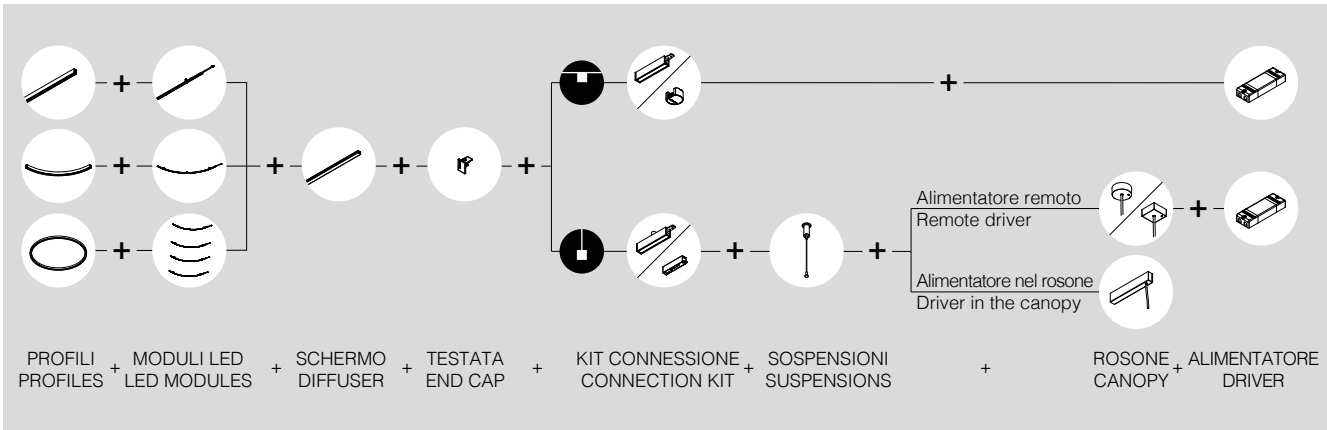

**MODULI LED
LED MODULES**

Moduli LED alimentabili a 48V provvisti di connettori in testa e coda per la connessione rapida in linea continua ed agganci plastici per il montaggio sul profilo. Max 80W installabili in linea continua.



48V LED modules equipped with connectors on both sides for fast continuous line connection and plastic hooks for mounting on the profile. Max 80W can be installed in continuous line.

MODULO LED LINEARE

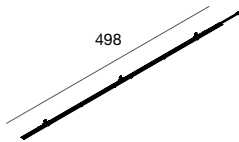

LINEAR LED MODULE

					L (mm)
112209.99	2700K	6,6W	861 lm		498
112210.99	3000K	6,6W	915 lm		498
112211.99	4000K	6,6W	978 lm		498

MODULO LED R300 45°

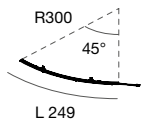

LED MODULE R300 45°

					L (mm)
112212.99	2700K	3,3 W	435 lm		249
112213.99	3000K	3,3 W	462 lm		249
112214.99	4000K	3,3 W	493 lm		249

MODULO LED R300 90°

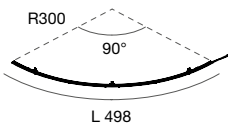

LED MODULE R300 90°

					L (mm)
112215.99	2700K	6,6 W	866 lm		498
112216.99	3000K	6,6 W	910 lm		498
112217.99	4000K	6,6 W	971 lm		498

MODULO LED R600 45°

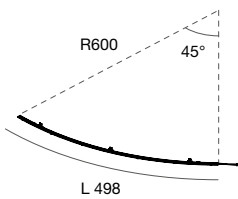

LED MODULE R600 45°

					L (mm)
112218.99	2700K	6,6 W	862 lm		498
112219.99	3000K	6,6 W	916 lm		498
112220.99	4000K	6,6 W	980 lm		498

MODULO LED R600 90°

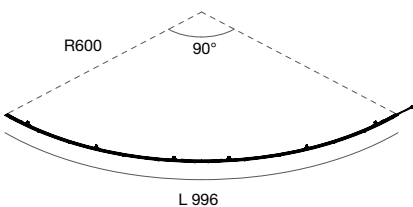

LED MODULE R600 90°

					L (mm)
112221.99	2700K	13,2 W	1724 lm		996
112222.99	3000K	13,2 W	1832 lm		996
112223.99	4000K	13,2 W	1960 lm		996

DOMYNOS PS

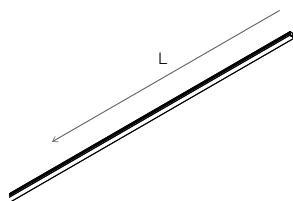
ACCESSORI
ACCESSORIES

SCHERMO OPALE 6m
Schermo curvabile e tagliabile in opera

OPAL DIFFUSER SHADE 6m
Bendable diffuser shade,
can be cut on site.

L (mm)

110825.99 6000 Opale / Opal



2

TESTATA TERMINALE (1 pz)
Da prevedere a inizio e fine linea
continua.

END CAP (1 pc)
To be provided at the beginning
and end of continuous line.



112224. __ 01 02 20 21

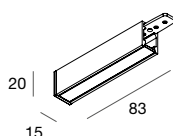

KIT CONNESSIONE INIZIO LINEA
PER INSTALLAZIONE A PLAFONE
Completo di testata terminale e cavetti
per la connessione elettrica tra LED
ed alimentazione 48V. Non idoneo per
composizioni chiuse. Alimentazione
48V da ordinare a parte.

LINE START CONNECTION KIT
FOR CEILING INSTALLATION
Complete with end cap and cables for
the electrical connection between LED
and 48V driver. Not suitable for
closed compositions. 48V driver to be
ordered separately.



112225. __ 01 02 20 21

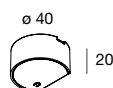
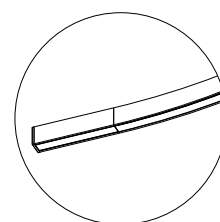

KIT CONNESSIONE INIZIO LINEA
O CENTRALE PER INSTALLAZIONE
A PLAFONE
Completo di cavetti per la connessione
elettrica tra LED ed alimentazione 48V.
Alimentazione 48V da ordinare a parte.

LINE START OR MIDDLE LINE
CONNECTION KIT
FOR CEILING INSTALLATION
Complete with cables for the electrical
connection between LED and 48V
driver. 48V driver to be ordered
separately.



112226. __ 01 02 20 21

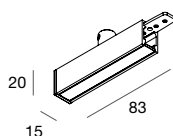
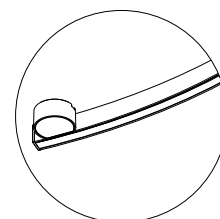
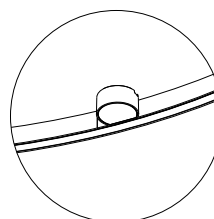

KIT CONNESSIONE INIZIO LINEA
PER INSTALLAZIONE
A SOSPENSIONE
Completo di testata terminale e cavetti
per la connessione elettrica tra LED
ed alimentazione 48V. Non idoneo
per composizioni chiuse. Driver box
o rosone ed alimentatore 48V da
ordinare a parte.

LINE START CONNECTION KIT
FOR SUSPENDED INSTALLATION
Complete with end cap and cables
for the electrical connection between
LED and 48V driver. Not suitable for
closed compositions. Driver box or
canopy and 48V driver to be ordered
separately.



112227. __ 01 02 20 21

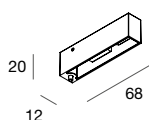
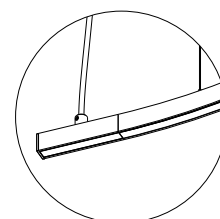

KIT CONNESSIONE INIZIO LINEA
O CENTRALE PER INSTALLAZIONE
A SOSPENSIONE
Completo di cavetti per la
connessione elettrica tra LED ed
alimentazione 48V. Driver box o
rosone ed alimentatore 48V da
ordinare a parte.

LINE START OR MIDDLE LINE
CONNECTION KIT
FOR SUSPENDED INSTALLATION
Complete with cables for the electrical
connection between LED and 48V
driver. Driver box or canopy and 48V
driver to be ordered separately.



112228. __ 01 02 20 21

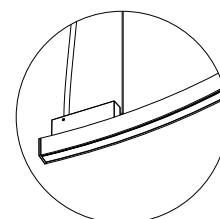
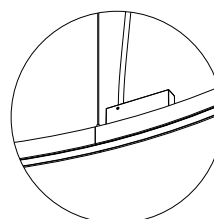

DOMYNOS PS

ACCESSORI ACCESSORIES

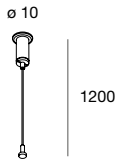

CAVO DI SOSPENSIONE (1pz)
In acciaio, regolabile.
1 pz a inizio e fine linea continua e
in ciascuna giunzione tra profili. 1pz
aggiuntivo per fissaggio centrale dei profili
cod. 112203.___ e 112207.___.
3 pz per il profilo 112208.___.

	L (mm)
112229.99	1200

SUSPENSION CABLE (1pc)
Made of steel, adjustable. 1 pc at the
beginning and end of continuous line and
in each junction between profiles. 1pc
more in the middle of profiles 112203.___
and 112207.___.
3 pcs for profile 112208.___.

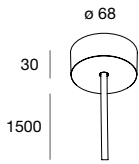

**ROSONE TONDO
ALIMENTAZIONE REMOTA**
Rosone a plafone. Cavo 2x1mm² con
guaina in tinta per bianco e nero e
trasparente per caffè e cappuccino.
Alimentazione 48V da ordinare a parte.

				L (mm)
109003.___ 01 02 20 21				1500

**ROUND CANOPY
REMOTE DRIVER**
Ceiling canopy. Cable 2x1mm² with
matching sheath for black and white and
transparent for caffè and cappuccino.
48V driver to be ordered separately.

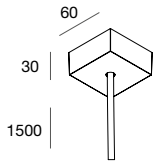

**ROSONE QUADRATO
ALIMENTAZIONE REMOTA**
Rosone a plafone. Cavo 2x1mm² con
guaina in tinta per bianco e nero e
trasparente per caffè e cappuccino.
Alimentazione 48V da ordinare a parte.

				L (mm)
109004.___ 01 02 20 21				1500

**SQUARE CANOPY
REMOTE DRIVER**
Ceiling canopy. Cable 2x1mm² with
matching sheath for black and white and
transparent for caffè and cappuccino.
48V driver to be ordered separately.

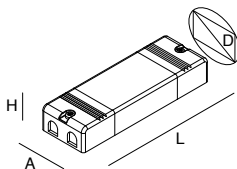

**ALIMENTATORE ELETTRONICO
STABILIZZATO 48V 220-240V 50/60 Hz**
Per dimmerazione prevedere
l'interfaccia 105914.99/105923.99.
Kit di connessione LED-alimentatore da
ordinare a parte.

	A (mm)	D (mm)	H (mm)	L (mm)	
101314.99	100W	65	75	35	140
101337.99	150W	63	75	35	180
101313.99	320W	90	100	45	250

**ELECTRONIC STABILIZED DRIVER 48V
220-240V 50/60Hz**
Dimming with addition of
105914.99/105923.99
dimming interface.
LED-power supply connection kit to be
ordered separately.

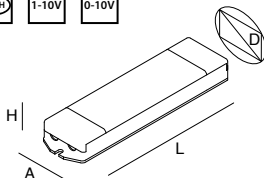
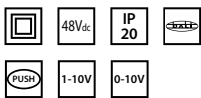

INTERFACCIA DI DIMMERAZIONE 48Vdc
Massimo carico 12Ax1 canale.
Da associare ad un alimentatore 48Vdc.

	A (mm)	D (mm)	H (mm)	L (mm)
105914.99	38	44	25	164

INTERFACE FOR DIMMING 48Vdc
Maximum load 12Ax1CH.
To be associated with one driver 48Vdc.

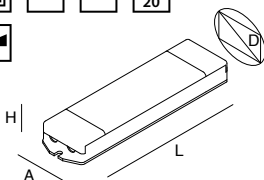
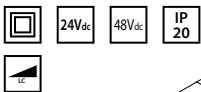

**INTERFACCIA DI DIMMERAZIONE
24Vdc/48Vdc**
A TAGLIO DI FASE PER STRIP LED
Massimo carico 10A.
Da associare ad un alimentatore
24Vdc/48Vdc.

	A (mm)	D (mm)	H (mm)	L (mm)
105923.99	36	41	20	140

**INTERFACE FOR DIMMING 24Vdc/48Vdc
PHASE CUT FOR LED STRIP**
Maximum load 10A.
To be associated with one driver
24Vdc/48Vdc.

DOMYNOS PS

DRIVER BOX

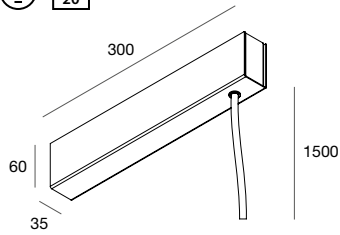

BOX CON ALIMENTAZIONE INTEGRATA 100W 48V
 Box a plafone. Cavo 2x1mm² con guaina in tinta per bianco e nero e trasparente per caffè e cappuccino.

BOX WITH INTEGRATED DRIVER 100W 48V
 Ceiling box. Cable 2x1mm² with matching sheath for black and white and transparent for caffè and cappuccino.

				A (mm)	H (mm)	L (mm)
112230...	01	02	20	21	100W	35 60 300

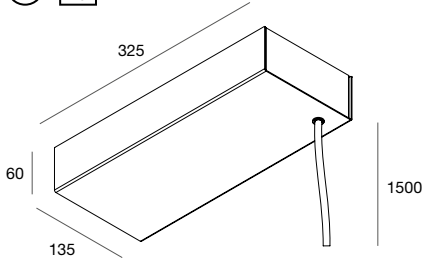

BOX CON ALIMENTAZIONE INTEGRATA DIMMERABILE 150W 48V
 Box a plafone. Cavo 2x1mm² con guaina in tinta per bianco e nero e trasparente per caffè e cappuccino.

BOX WITH INTEGRATED DIMMABLE DRIVER 150W 48V
 Ceiling box. Cable 2x1mm² with matching sheath for black and white and transparent for caffè and cappuccino.

				A (mm)	H (mm)	L (mm)
112232...	01	02	20	21	150W	135 60 325

INSTALLAZIONE A PLAFONE ALIMENTAZIONE A INIZIO LINEA CEILING INSTALLATION START OF LINE POWER CONNECTION

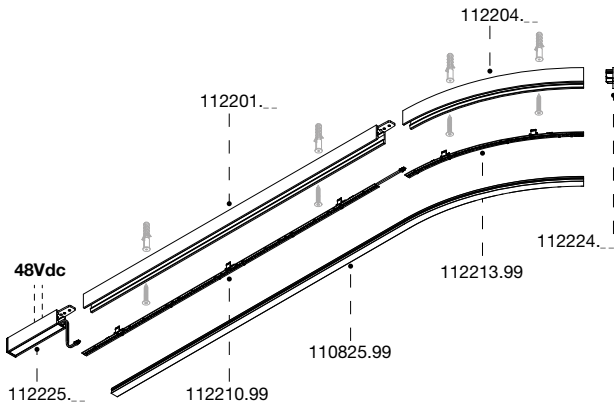

INSTALLAZIONE A PLAFONE ALIMENTAZIONE CENTRALE CEILING INSTALLATION CENTRAL POWER CONNECTION

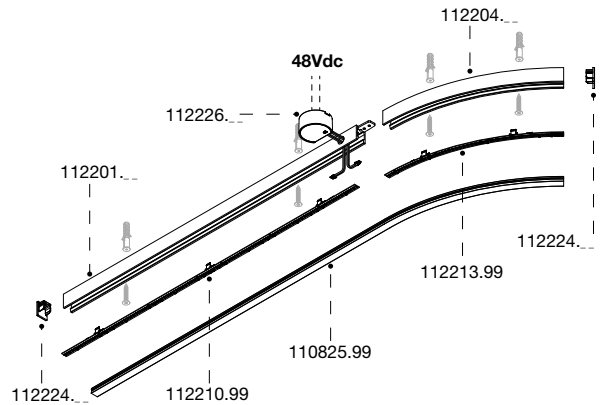

INSTALLAZIONE A SOSPENSIONE ALIMENTAZIONE A INIZIO LINEA SUSPENSION INSTALLATION START OF LINE POWER CONNECTION

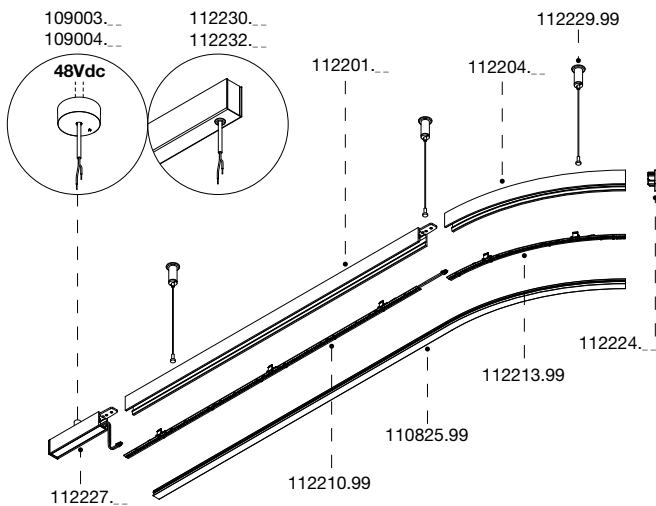

INSTALLAZIONE A SOSPENSIONE ALIMENTAZIONE CENTRALE SUSPENSION INSTALLATION CENTRAL POWER CONNECTION

