

# B-1 / B-2 / B-3 / B4

LE GARANZIE PRODOTTO SARANNO APPLICABILI, PER RAGIONI DI SICUREZZA E FRUIIBILITÀ, SOLO UTILIZZANDO STRIPLED ED ALIMENTAZIONI NOVALUX. THE PRODUCT WARRANTY CONDITIONS WILL APPLY, DUE TO REASONS OF SAFETY AND QUALITY OF USE, ONLY WHEN INSTALLED WITH THE STRIPLED AND DRIVERS FROM NOVALUX CATALOGUES.



Profilo per Strip LED tagliabile in opera per installazione a parete. Corpo e testate terminali in cartongesso, profilo dissipante in lega di alluminio anodizzata naturale. Staffe per installazione a parete in lamiera di acciaio zincata e verniciata, schermo di protezione in PMMA opale. Strip LED, testate terminali ed alimentatore elettronico 24Vdc da ordinare a parte.

Profile for Strip LED for wall surface mounting. Body and end caps made of plasterboard, dissipating profile in anodized aluminium alloy natural finish. Brackets in galvanized painted steel, PMMA opal screen. Strip LED, end caps and electronic driver 24 Vdc to be ordered separately.

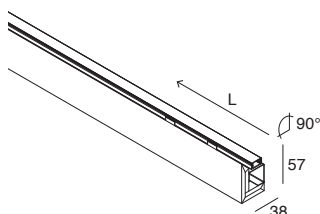

## B-1

Tagliabile in max 3 profili di lunghezza minima 250 mm. Includere 3 staffe per il montaggio. Alimentatore remoto.

Cutttable in max 3 profiles up to a minimum length of 250 mm. 3 brackets included. Remote driver.

CODE L (mm)

<b>11119.99</b>	2000
-----------------	------

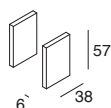

TESTATE DI CHIUSURA (2 pz.)  
END CAPS (2 pcs)

CODE

<b>11122.99</b>	
-----------------	--

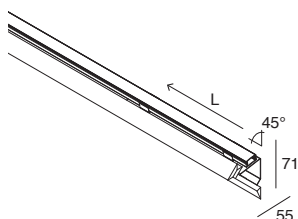

## B-2

Tagliabile in max 3 profili di lunghezza minima 250 mm. Includere 3 staffe per il montaggio. Alimentatore remoto.

Cutttable in max 3 profiles up to a minimum length of 250 mm. 3 brackets included. Remote driver.

CODE L (mm)

<b>11120.99</b>	2000
-----------------	------

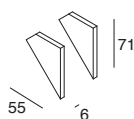

TESTATE DI CHIUSURA (2 pz.)  
END CAPS (2 pcs)

CODE

<b>11123.99</b>	
-----------------	--

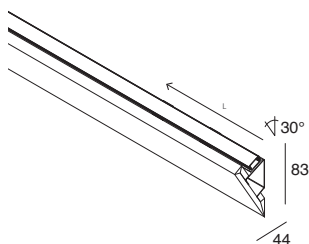

## B-3

Tagliabile in max 3 profili di lunghezza minima 250 mm. Includere 3 staffe per il montaggio. Alimentatore remoto.

Cutttable in max 3 profiles up to a minimum length of 250 mm. 3 brackets included. Remote driver.

CODE L (mm)

<b>11121.99</b>	2000
-----------------	------

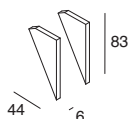

TESTATE DI CHIUSURA (2 pz.)  
END CAPS (2 pcs)

CODE

<b>11124.99</b>	
-----------------	--

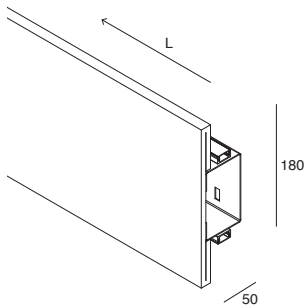
**B-1 / B-2 / B-3 / B4****B-4**

Tagliabile in max 4 profili di lunghezza minima 300 mm  
Incluse 4 staffe per il montaggio  
Alimentatore alloggiabile nel profilo  
(vedi accessori).

Cuttable in max 4 profiles up to a minimum length of 300 mm  
4 brackets included  
Driver suitable inside the profile  
(see accessories).

CODE L (mm)

<b>101869.99</b>	2000
------------------	------

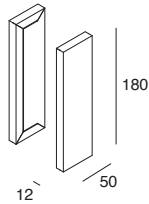

TESTATE DI CHIUSURA (2 pz.)  
END CAPS (2 pcs)

CODE

<b>101870.99</b>	
------------------	--

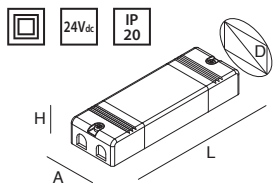
**B-1 / B-2 / B-3 / B4****ACCESSORI  
ACCESSORIES**

ALIMENTATORI 24Vdc  
INSERIBILI NEL PROFILO  
Vedi sezione Gestione Luce

DRIVERS 24Vdc  
THAT FIT IN THE PROFILE  
See section Light Management

CODE POWER VERSION

<b>101301.99</b>	45W	ON-OFF
------------------	-----	--------

<b>101302.99</b>	100W	ON-OFF
------------------	------	--------

<b>101318.99</b>	80W	DALI/PUSH (White) - DALI (RGB/RGBW/TW)
------------------	-----	--

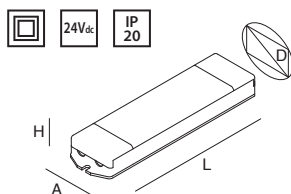

INTERFACCE DI DIMMERAZIONE 24Vdc  
INSERIBILI NEL PROFILO  
Vedi sezione Gestione Luce

INTERFACES FOR DIMMING 24Vdc  
THAT FIT IN THE PROFILE  
See section Light Management

CODE POWER VERSION

<b>105914.99</b>	max 12Ax1CH	DALI/PUSH/0-10V/1-10V
------------------	-------------	-----------------------

<b>105908.99</b>	max 20Ax1CH	DALI/PUSH/0-10V/1-10V/LC
------------------	-------------	--------------------------

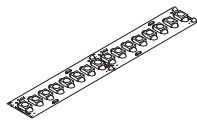
**STRIP LED**

Pag. 196