

# N 4 ELITE



---

## Elite.

Unsere **Wahl** um Räume zu verschönern,  
damit sie sich abheben, um Ihren **kostbaren Momenten**  
einen **besonderen Glanz** zu verleihen

## Elite.

Our choice

To adorn rooms so they will stand out

To add a sparkle to your precious moments

---

# Elite. Lassen Sie sich inspirieren

Elite.  
Let yourself be inspired



**Novalux** erweitert seinen Horizont und präsentiert eine Reihe von **hochwertigen** und **dekorativen** Produkten, die in Europa hergestellt werden. **Edle Materialien** wie massives Messing, Samt, edle Textilien und hochwertiges, in eleganten Farben lackiertes Aluminium. Alle Artikel der Elite-Familie sind **retrofit**, um dem Benutzer die Möglichkeit zu geben, die Lichtquellen mit äußerster Einfachheit auszuwählen und zu warten. **Lassen Sie sich inspirieren** von neuen Formen, Farben und Ausführungen und treten Sie ein in die Welt von Elite.



Novalux expands its horizons and presents a line of **high quality decorative** products made in Europe. **Precious materials** such as solid brass, velvets, fabrics and aluminium painted in elegant colours. All items of the Elite family are **retrofit**, to give the user the opportunity to choose and maintain the light sources with extreme simplicity.

**Be inspired** by new shapes, colors and finishes, enter the world of Elite.





28	CALIMERO
68	CHANEL PT
76	CHANEL TL
32	COLLINS PL
54	COLLINS PR
20	COLLINS SP
24	CRYSTAL
60	CUBRIK
70	DIANA
42	GECO
46	HONEY IN
38	HONEY PL
56	HONEY PR
64	HONEY PT
74	HONEY TL
48	MIND
36	MISS PL
58	MISS PR
50	SPIRIT
66	TINY PT
78	TINY TL

# KOLLEKTIONEN | COLLECTIONS

## COLLINS

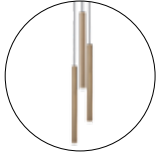

COLLINS SP  
20



COLLINS PL  
32

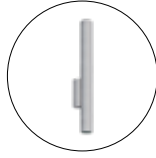

COLLINS PR  
54

## MISS

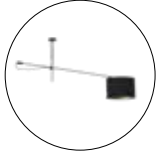

MISS PL  
36



MISS PR  
58

## HONEY



HONEY PL  
38



HONEY IN  
46



HONEY PR  
56



HONEY PT  
64



HONEY TL  
74

## TINY



TINY PT  
66



TINY TL  
78

## CHANEL



CHANEL PT  
68



CHANEL TL  
76

# INSTALLATIONEN | INSTALLATIONS

## SP PENDELLEUCHTEN | SUSPENSION

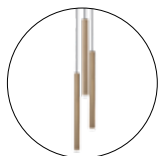

COLLINS SP  
20



CRYSTAL  
24



CALIMERO  
28

## PL DECKENLEUCHTEN | CEILING



COLLINS PL  
32

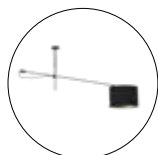

MISS PL  
36



HONEY PL  
38



GECO  
42

## IN EINBAULEUCHTEN | RECESSED



HONEY IN  
46



MIND  
48



SPIRIT  
50

## PR WANDLEUCHTEN | WALL

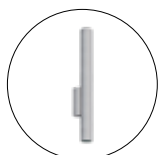

COLLINS PR  
54



MISS PR  
58



HONEY PR  
56

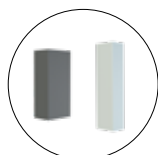

CUBRIK  
60

## PT STEHLEUCHTEN | FLOOR



HONEY PT  
64



TINY PT  
66



CHANEL PT  
68



DIANA  
70

## TL TISCHLEUCHTEN | TABLE



HONEY TL  
74



TINY TL  
78



CHANEL TL  
76

# SYMBOLS | SYMBOLES



**IN** In die Gipskartondecke eingebaut  
Recessed into plasterboard ceiling



**PL** Deckenmontage  
Ceiling



**PR** Wandmontage  
Wall



**SP** Pendelmontage  
Suspended



**PT** Stehleuchte  
Floor lamp



**TL** Tischlampe  
Table lamp



Grad des Schutzes von Fremdkörpern in fester und flüssiger Form  
Protection class against foreign bodies and water



Netzspannung  
Mains voltage



Hergestellt in Europa  
Made in Europe



5 Jahre Garantie  
5 Years warranty

# OBERFLÄCHEN | FINISHES

## BESCHICHTETES METALL | PAINTED METAL



**.01** Weiß  
White  
RAL 9003



**.02** Schwarz  
Black  
RAL 9005



**.23** Hellgrau  
Light grey  
RAL 7044



**.24** Dunkelgrau  
Dark grey  
RAL 7022

## MASSIVES MESSING | SOLID BRASS



**.16** Geschütztes,  
satinieretes, massives  
Messing  
Protected satin solid

## SAMT | VELVET



**.27** Rosa Samt  
Pink velvet



**.28** Blauer Samt  
Blue velvet



**.29** Grüner Samt  
Green velvet

## LEINE | CANVAS



**.25** Weiße Leine  
White Canvas



**.26** Schwarze Leine  
Black canvas

# SO LÄSST SICH UNSEREN KATALOG LESEN

## HOW TO READ OUR CATALOGUE

**Produktname**  
Product name

**Beschreibung**  
Description

**Referenzbild**  
Reference image

**Kollektion:**  
alle Arten von  
Produktinstallationen  
Collection:  
all types of product  
installation

**FARBE COLOR**

**PRODOTTO**  
PISTOLETTA  
PISTOLETTA

**CORPO PER SPOT**  
SPOT BODY

**ACCESSORI OPZIONALI**  
OPTIONAL ACCESSORIES

**COLLEZIONE HONEY / HONEY COLLECTION**

**MATERIALI E SUPERFICI**  
Materials and finishes

**Disegni in mm**  
Drawings in mm

**Articoli e Tabelle**  
Codes tables

**Materiali e Superfici**  
Materials and finishes

**Disegni in mm**  
Drawings in mm

**Articoli e Tabelle**  
Codes tables

## MERKMALE DER LICHTQUELLEN

### LIGHT SOURCES FEATURES

Separat zu kaufende Glühbirnen gemäß den Angaben in der Tabelle  
Bulbs to buy separately according to the indications in the table

 1x GU10 LED max 10W Ø51mm H55mm

**Maximale Höhe**  
Maximum height

**Maximaler Durchmesser**  
Maximum diameter

**Maximale Leistung**  
Maximum power

**Glühbirnen-Typ**  
Type of bulb

**Anzahl Lichtquellen**  
N° light sources

**Symbol Glühbirne**  
Bulb symbol

# FARBE COLOR

Gestalte dein Produkt: Wähle das Gehäuse und das Zubehör, indem du Farben kombinierst

Create your product: choose the body and accessories by combining colors

Dieses Symbol bedeutet, dass das Produkt zusammengesetzt werden kann  
This icon means that the product is to be composed

Produktkörper  
Product body

Erforderliches Zubehör  
Mandatory accessories

Optionales Zubehör  
Optional accessories

**PRODUKT**  
FIXTURE

**SPOT KÖRPER**  
SPOT BODY

**OPTIONALES ZUBEHÖR**  
OPTIONAL ACCESSORIES

**BASIS**  
.01 .02 Texturierter lackierter Stahl

**BASE**  
.01 .02 Texturized painted steel

**SPOT**  
.01 .02 Texturierter lackierter Stahl  
.16 Satiniertes, massives Messing

**SPOT**  
.01 .02 Texturized painted steel  
.16 Satin solid brass

47

(MANS)

**HONEY IN**

112404. \_\_ 01 02

1x GU10 LED max 10W Ø51mm H55mm

**ERFORDERLICHES ZUBEHÖR**  
MANDATORY ACCESSORIES

Spot Körper / Spot body

112909. \_\_ 01 02

112909. \_\_ 16

**OPTIONALES ZUBEHÖR**  
OPTIONAL ACCESSORIES

Dekorativer Diffusor / Decorative diffuser

112903.99  
Für weiße und schwarze Spots / For white and black spots

112904.99  
Für Messing Spot / For brass spot





**FIRMENPROFIL**  
COMPANY PROFILE

# Schalten Sie das Licht ein

## Turn on the light

---

**Novalux** ist ein Beispiel für ein emilianisches Familienunternehmen, das von Gino Persiani gegründet wurde. Er wurde 1910 geboren und war bei Ausbruch des Zweiten Weltkriegs 30 Jahre alt. Ausgerechnet in Deutschland **sieht er zum ersten Mal die Leuchtstoffröhren** auf den deutschen U-Booten und beginnt davon zu träumen, wie man diese Lichtquelle nutzen könnte. In einem selbst entworfenen, maßgeschneiderten Konzept wird diese innovative Energiequelle zu einem echten Beleuchtungsgerät. Im Jahr 1948 wird Novalux gegründet. Die Arbeit und der **Erfolg von Novalux** werden heute von Ginos Enkel fortgesetzt. Alessandro Sgrignoli hat die Intuition und den unternehmerischen Mut seines Großvaters geerbt und führt das Unternehmen mit der gleichen **Entschlossenheit und Weit-sicht**.

Novalux is an example of an Emilian Family entrepreneurship, started by Gino Persiani. He was born in 1910 and at the outbreak of World War II, he was 30 years old. Precisely in Germany he **sees for the first time the fluorescent tubes** on the German submarines and starts dreaming about how to use this lighting source. As a self-designed tailored dress, this innovative source of energy becomes a real lighting device. In 1948 Novalux is established. The work and **SUCCESS of Novalux** continue today with Gino's grandson. Alessandro Sgrignoli inherited his grandfather's intuition and entrepreneurial courage, while leading the company with the same **determination and foresight**.

**Jahre Erfahrung**

**75**

Years of experience

**Made in Italy Artikel**

**17400**

Made in Italy items

**aktive Codes**

**4755**

Active codes

**verkaufte Profile pro Jahr**

**500km**

Profiles sold in a year

**verkaufte LED-Streifen pro Jahr**

**700km**

LED strips sold in a year

**Betriebsfläche**

**30000m<sup>2</sup>**

Company area

**Produktionsbereich**

**12000m<sup>2</sup>**

Production area

**Italian lighting design**  
since 1948

# Beleuchtung, Schritt für Schritt

## Lighting, step by step

**1948**

### Entstehung von Novalux

Gino Persiani entdeckt während des Zweiten Weltkriegs die Leuchtstoff-röhren. Er verwandelt sie in Beleuchtungs-körper und gründet Novalux.

#### Novalux is born

Gino Persiani, during the WWII, discovers the fluorescent tubes. Turns them into lighting fixtures and founds Novalux.

**1950**

### Erstes Projekt

Um sich bekannt zu machen, hat Gino Persiani ein Geschäft unter den Arkaden von Bologna kostenlos beleuchtet.

#### First project

Gino Persiani, to make himself known, illuminates for free of charge a shop under the arcades of Bologna.

**1975**

### Neuer Standort

Novalux zieht in den neuen Firmensitz in Funo di Argelato (Bologna) ein.

#### New location

Novalux moves to the new industrial headquarters in Funo di Argelato (Bologna).

**1986**

### Erste Messe

Novalux nimmt an der Messe Tech Lighting in Mailand teil.

#### First fair

Novalux participates at the Fair Tech Lighting of Milan.

**2017**

### Espansione

Ein großes Unternehmen braucht mehr Platz: ein neues Lager am Hauptsitz von Novalux.

#### Expansion

A major business requires more space: a new warehouse in headquarters Novalux.

**2019**

### Übernahme von SLV

Novalux schließt sich der SLV Lighting Group Integration an. Ihre Zweigstellen im Ausland befinden sich, in Frankreich, Belgien und der Schweiz.

#### Acquisition of SLV

Novalux integrates with SLV Lighting Group Integration. Its headquarters arrive abroad, in France, Belgium and Switzerland.

**2022**

### ISO-Zertifizierung

Novalux erwirbt die Zertifizierung des integrierten Qualitäts- und Umwelt-managementsystems nach den Normen UNI EN ISO 9001:2015 und UNI EN ISO 14001:2015.

#### ISO certification

Novalux acquires the System certification integrated management for Quality and the Environment, according to the rules UNI EN ISO 9001:2015 and UNI EN ISO 14001:2015

**2023**

### 75-jähriges Jubiläum

Seit 1948: 75 Jahre Beleuchtungen von Novalux.

#### 75° anniversary

Since 1948: 75 years of lighting Novalux registered.

**Grünes Licht** für Nachhaltigkeit. Reduzieren, Recyceln, Wiederverwenden:

Novalux glaubt fest an die Bedeutung von Nachhaltigkeit und an den **Schutz des Planeten**, für eine grünere Welt.

Green light for sustainability. Reduce, Recycle, Reuse: Novalux strongly believes in the importance of sustainability and in **safeguarding the Planet**, for a greener world.

# Licht auf Nachhaltigkeit

## Light on sustainability

○ **PRODUKTE MIT HOHER ENERGIEEFFIZIENZ**  
HIGH ENERGY EFFICIENCY PRODUCTS

○ **CO<sub>2</sub>-EINSPARUNGEN DANK PHOTOVOLTAIKANLAGE**  
CO<sub>2</sub> SAVINGS THANKS TO PHOTOVOLTAIC SYSTEM

○ **KATALOGE UND VERPACKUNGEN MIT FSC® MARKENZEICHEN**  
FSC® BRANDED CATALOGUES AND PACKAGING

○ **RECYCLING STATT ENTSORGUNG**  
RECYCLING, RATHER THAN DISPOSING

○ **UMWELTFREUNDLICHES TEAM:**

**NACHHALTIGKEIT WIRD JEDEN TAG GELEBT. WIR BEWEGEN UNS MIT DEM FAHRRAD ODER MIT HYBRID- UND ÖKO-AUTOS, THERMOWASSERFLASCHEN UND WERKZEUGE AUS RECYCLINGPAPIER, GLAS WIRD DEM PLASTIK VORGEZOGEN.**

ECO-FRIENDLY TEAM: SUSTAINABILITY IS CHOSEN EVERY DAY. WE MOVE BY BIKE OR WITH HYBRID AND ECOLOGICAL CARS, THERMAL WATER BOTTLES AND TOOLS MADE WITH RECYCLED PAPER, GLASS IS PREFERRED TO PLASTIC.

**NACHHALTIGKEIT** >  
SUSTAINABILITY



**ZERTIFIZIERUNG** >  
CERTIFICATIONS



# Hauptquartier

## Headquarter

### NOVALUX ITALIEN

Via Marzabotto 2  
40050 Funo di Argelato (BO)

Tel. +39 051 860558  
Fax +39 051 6647859  
info@novalux.it

P.I. 00536541204

Aktivitäten des Unternehmens werden verwaltet  
und koordiniert durch SLV GmbH

Company activities managed  
and coordinated by SLV GmbH



## Vertriebsnetz im Ausland

### Export sales network

export@novalux.it

#### NOVALUX BELGIEN

##### TOCHTERGESELLSCHAFT

Herentalsebaan 429  
2160 Wommelgem  
Tel. +32 3 385 30 08  
info@novaluxlighting.be

##### STUDIO

Kloosterstraat 18  
2000 Antwerpen  
Tel. +32 3 385 30 08

#### NOVALUX FRANKREICH

##### TOCHTERGESELLSCHAFT

Zac du Martelet 88  
Rue Henri Dépaigneux  
F-69400 LIMAS  
Tel. +33 4 69 47 00 00  
info@novaluxlighting.fr

#### NOVALUX SCHWEIZ

##### TOCHTERGESELLSCHAFT

Route du Bey 6 Box 1-4  
Z.I. La Jonnaire  
CH-1847 Rennaz  
Tel. +41 21 811 32 32  
info@novaluxlighting.ch

##### STUDIO

Grünaustrasse 18  
CH-8953 Dietikon  
Tel. +41 21 811 32 49

#### SPANIEN

##### AGENTUR Buio Light SL

Calle Héroes Dos de Mayo 3  
29640 Fuengirola, Malaga  
Tel. +34 666714024  
light@buio.es  
info@novaluxlighting.fr

# Vertriebsnetz Italien

## Italy sales network

### VALLE D'AOSTA - PIEMONTE

LIGHT TEAM Snc  
Corso Racconigi, 170  
10141 Torino  
info@agenzialt.it  
Cell. Sergio Fichera 335 7206500  
fichera@agenzialt.it  
Cell. Niccolò Masinari 349 2141677  
masinari@agenzialt.it

### LIGURIA

LAZZARINI MAURO  
Via della Pineta, 58/2  
16011 Arenzano (GE)  
Cell. 347 1532185  
mauro.lazzarini@gmail.com  
www.lazzarinimauro.com

### TOSCANA

CHELINI ILLUMINOTECNICA  
di Chelini Filippo  
Via Vittorio Emanuele, 33  
50041 Calenzano (FI)  
Tel. 055 8811208  
Cell. Filippo Chelini 335 6109402  
Cell. Daniele Cammelli 335 6118944  
Cell. Paolo Nuzzolese 338 6250103  
info@chelinilluminotecnica.it

### SARDEGNA

Costa Danilo  
Via Torres 7/C  
07100 Sassari  
Tel./Fax 079 4922990  
Cell. Danilo Costa 335 6079614  
costadanilo.dc@gmail.com

### SICILIA

SVR S.r.l.  
Viale Resurrezione, 19  
90146 Palermo  
Tel. 091 6791971  
Fax 091 6791960  
Cell. Vincenzo Salerno 335 5762757  
info@svrsalerno.it  
Progettazione illuminotecnica  
Rosario Mulièdda  
Cell. 335 1331776  
mulièdda@svrsalerno.it

### LOMBARDIA

CERVO RAPPRESENTANZE  
di De Pascalis Riccardo & C SaS  
Via Papa Giovanni II, 20  
24058 Fara Olivana con Sola (BG)  
ag.cervo.commerciale@gmail.com  
commerciale@cervorap.com  
(Bergamo, Brescia, Cremona, Mantova,  
Monza-Brianza, Milano provincia, Lodi, Sondrio)  
Cell. Riccardo De Pascalis 340 4076095  
Cell. Carlo Cattaneo 347 4618150  
(Como, Lecco, Varese, Milano città, Pavia)  
Cell. Rinaldo Roberti 335 458140  
Progettazione illuminotecnica  
Mariangela Giacomazzi  
Cell. 333 3394396  
mg68.design@gmail.com

### MARCHE - UMBRIA

DLR Srl  
Via Colle Pineta, 23  
65129 Pescara  
Tel./Fax 085 4516270  
Cell. Roberto Di Leonardo 337 913221  
Cell. Gabriele Luzi 334 9100399  
info@dlrrappresentanze.it

### LAZIO

3EL Snc. Rappresentanze  
Uffici e showroom:  
via Ubaldo Montelatici, 26  
00134 Roma  
Tel. 06 71356133  
Cell. Fabio Buonadonna 335 6408457  
Cell. Roberto La Rosa 335 6408263  
Cell. Andrea Lupi 335 6408448  
info@3elrappresentanze.it  
www.3elrappresentanze.it  
Progettazione illuminotecnica  
STUDIOLUCE3  
Fabio Buonadonna  
Cell. 335 6408457  
progettazione@3elrappresentanze.it

### CAMPANIA

Punzo Salvatore  
Via Napoli, 159 C.C. Meridiana  
80013 Casalnuovo di Napoli (NA)  
Tel. 081 5228441  
Cell. Punzo Salvatore 337 971401  
Cell. Roberto Cirillo 334 6289262  
Cell. Esposito Davide 335 1370844  
info@luminattech.it

### CALABRIA

Lu Ce & C Srl  
Via S.S. Pietro e Paolo, 16  
87040 Cerzeto (CS)  
Cell. Luciano Celestino 393 4142443  
lu.ce.srl@gmail.com

### VENETO TRENTINO ALTO ADIGE FRIULI VENEZIA GIULIA

(Padova, Vicenza, Rovigo, Venezia)  
SITEL Srl (sede)  
Via Lisbona, 28/A  
35127 Padova  
Tel. 049 760999  
info@sitelx.it

(Verona, Trentino Alto Adige)  
SITEL Srl (filiale)  
Via Spagnole, 2/B  
37015 Sant' Ambrogio di Valpolicella (VR)  
Tel. 049 760999  
info@sitelx.it

(Treviso, Belluno, Friuli Venezia Giulia)  
SITEL Srl (filiale)  
Via Don Pietro della Toffola, 24  
33074 Fontanafredda (PN)  
Tel. 049 760999  
info@sitelx.it

### EMILIA ROMAGNA

B & Q ILLUMINOTECNICA Srl  
Centergross Blocco 2A n° 147  
40050 Funo di Argelato (BO)  
Tel. 051 861445  
Cell. Adriano Querciagrossa 348 7813992  
Cell. Lorenzo Pierini 348 7813993  
Cell. Daniele Molinari 348 0306938  
Cell. Mattia Grazi 388 4479463  
Cell. Andrea Bettuzzi 351 7584637  
info@bqsr.it  
www.bqsr.it

### ABRUZZO - MOLISE

DLR Srl  
Via Colle Pineta, 23  
65129 Pescara  
Tel./Fax 085 4516270  
Cell. Roberto Di Leonardo 337 913221  
info@dlrrappresentanze.it

### PUGLIA - BASILICATA

VERDEBELLO RAPPRESENTANZE Sas  
Via Don Guanella, 15/g  
70124 Bari  
Tel. 080 5023511 - 080 5024922  
Cell. Daniele Verdebello  
346 1007163  
info@verdebello.it  
d.verdebello@verdebello.it

(Bari, Barletta-Andria-Trani, Foggia e Basilicata)  
Cell. Dario De Francesco 347 1892574  
d.defrancesco@verdebello.it

(Lecce, Brindisi, Taranto)  
Cell. Cristian Campeggio 380 1013239  
c.campeggio@verdebello.it





**PENDELLEUCHTEN**  
SUSPENSION

# COLLINS SP

Zylinder für die Aufhängung, aus strukturiertem, lackiertem Stahl oder satiniertem, massivem Messing. Es sind verschiedene Durchmesser und Längen erhältlich, und sie können mit einfachen, 3x linearen oder 3x runden Schirmen kombiniert werden.

Cylinders for suspension installation, in textured painted steel or satin solid brass. Different diameters and lengths are available, and they can be combined with single, 3x linear or 3x round canopies.



## COLLINS KOLLEKTION | COLLINS COLLECTION



COLLINS SP  
Pg 20



COLLINS PL  
Pg 32

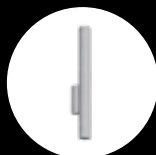

COLLINS PR  
Pg 54



# ERSCHAFFEN SIE IHRE COLLINS

## CREATE YOUR COLLINS

**FARBKOMBINATION:** Wählen Sie den Körper und das Zubehör durch die Kombination von Farben  
**COMBO COLOR:** Choose the body and accessories by combining colors

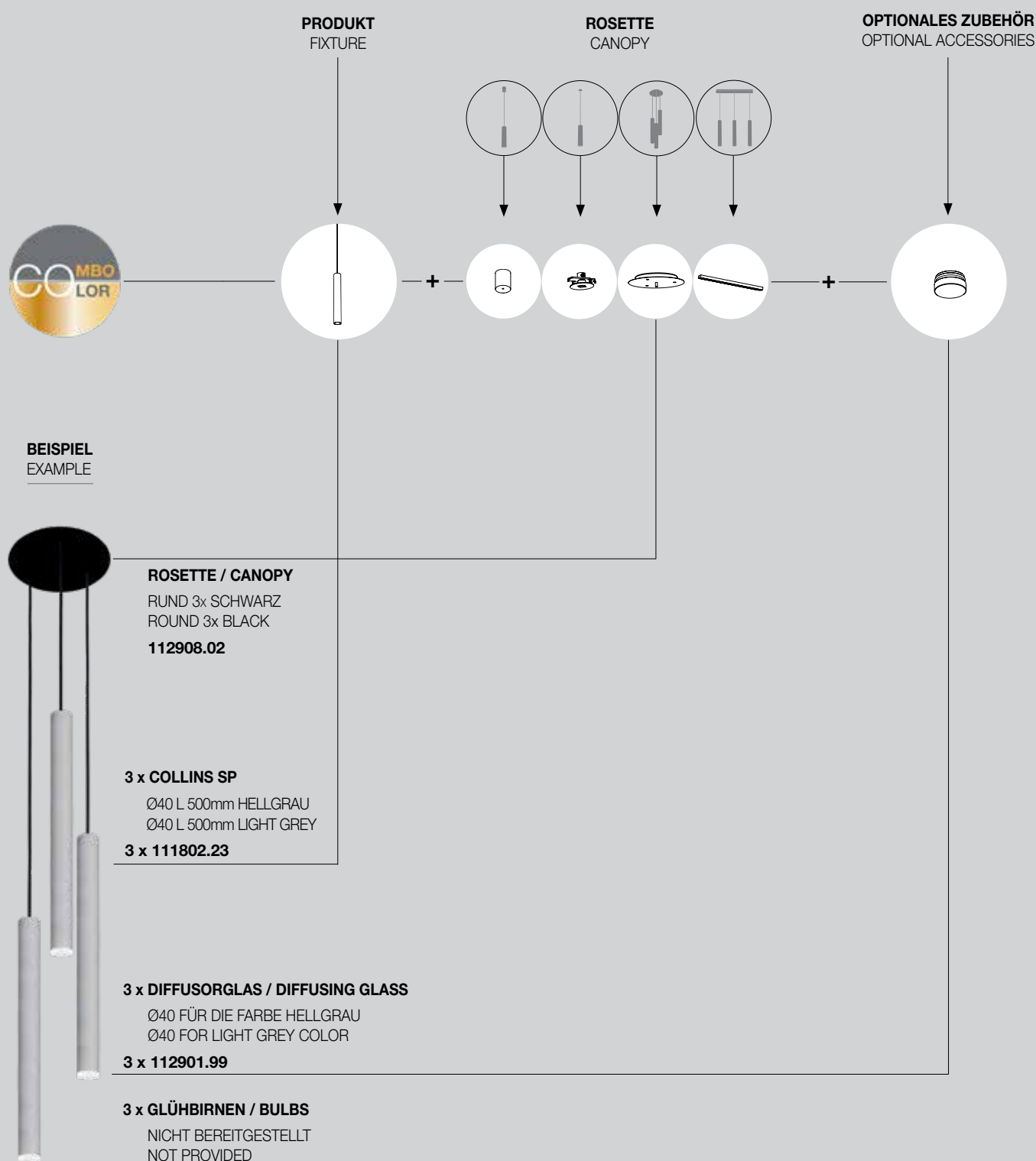



KABEL  
 Länge einstellbar  
 .01 Weißer Kabelmantel  
 .02 .23 .24 .16 Schwarzer Kabelmantel

CABLE  
 adjustable length  
 .01 White sheath  
 .02 .23 .24 .16 Black sheath



.01 .02 .23 .24 Texturierter lackierter Stahl  
 .16 Satiniertes, massives Messing  
 .01 .02 .23 .24 Texturized painted steel  
 .16 Satin solid brass

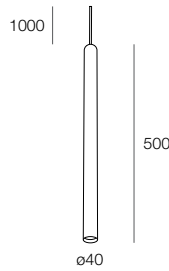
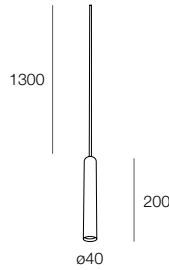

COLLINS SP Ø40

L 200mm



111801. \_\_ 01 02 23 24



111801. \_\_ 16

1x GU10 MINI LED max 10W Ø35mm H46mm

L 500mm



111802. \_\_ 01 02 23 24



111802. \_\_ 16

1x GU10 MINI LED max 10W Ø35mm H46mm

COLLINS SP Ø55

L 200mm



111803. \_\_ 01 02 23 24



111803. \_\_ 16

1x GU10 LED max 10W Ø51mm H55mm

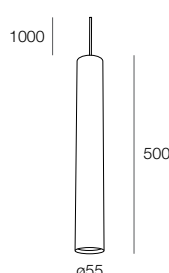
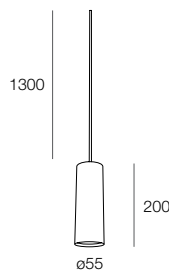

L 500mm



111804. \_\_ 01 02 23 24



111804. \_\_ 16

1x GU10 LED max 10W Ø51mm H55mm

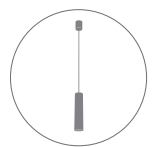

**ERFORDERLICHES ZUBEHÖR**  
MANDATORY ACCESSORIES

Rosetten / Canopies

1x für den Aufbau / 1x ceiling



**112905. \_\_ 01 02 23 24**

Zu kombinieren mit 1 Collins SP / To combine with 1 Collins SP

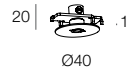
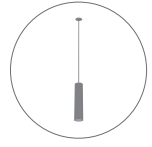

1x für den Einbau / 1x recessed



**112906. \_\_ 01 02 23 24**

Zu kombinieren mit 1 Collins SP / To combine with 1 Collins SP

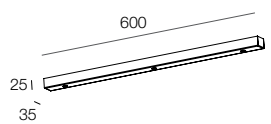
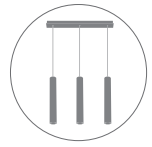

3x für linear / 3x linear



**112907. \_\_ 01 02 23 24**

Zu kombinieren mit 3 Collins SP / To combine with 3 Collins SP

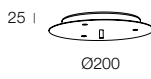

3x für rund / 3x round



**112908. \_\_ 01 02 23 24**

Zu kombinieren mit 3 Collins SP / To combine with 3 Collins SP

ROSETTEN  
.01 .02 .23 .24 Stahl lackiert

CANOPIES  
.01 .02 .23 .24 Painted steel



Ø 40mm



**112901.99**

Für Weiß, Schwarz, Dunkelgrau und Hellgrau / For white, black, dark grey and light grey

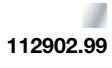

**112902.99**

Für Messing / For brass



Ø 55mm



**112903.99**

Für Weiß, Schwarz, Dunkelgrau und Hellgrau / For white, black, dark grey and light grey



**112904.99**

Für Messing / For brass

# CRYSTAL

Zylinder für Pendelmontage, außen mit extra klarem, transparentem Glas und innen aus lackiertem, strukturiertem Stahl oder satiniertem, massivem Messing. Sie können mit einzelnen, 3x linearen oder 3x runden Rosetten kombiniert werden.

Cylinders for pendant installation, with extra clear transparent glass outside, and painted texturized steel or satin solid brass inside. They can be combined with single, 3x linear or 3x round canopies.



# ERSCHAFFEN SIE IHREN CRYSTAL

## CREATE YOUR CRYSTAL

**FARBKOMBINATION:** Wählen Sie den Körper und das Zubehör durch die Kombination von Farben  
**COMBO COLOR:** Choose the body and accessories by combining colors

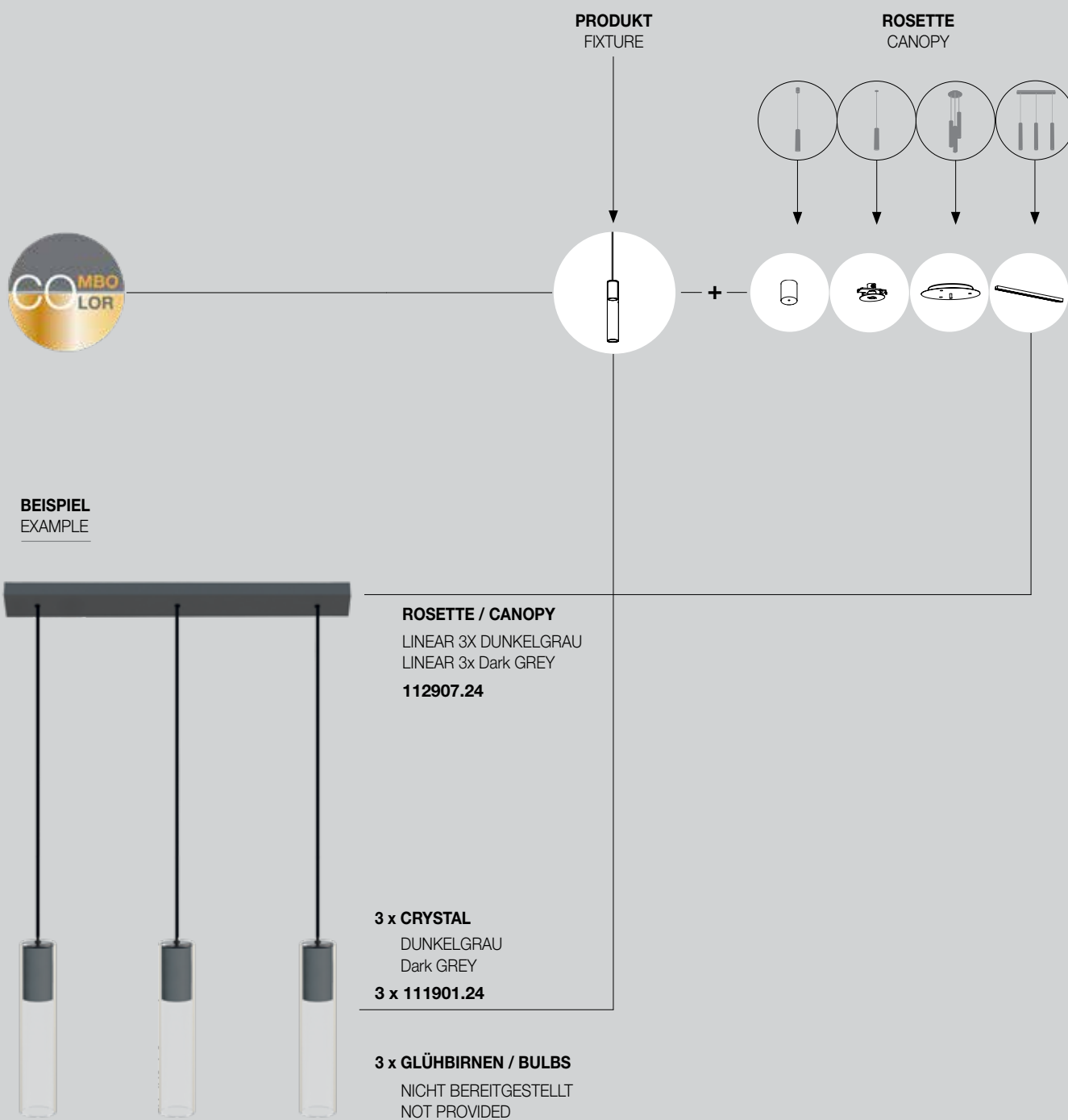



KABEL  
 einstellbare Länge  
 .23 .24 .16 Schwarzer Kabelmantel

CABLE  
 adjustable length  
 .23 .24 .16 Black sheath

.23 .24 Innen texturierter, lackierter Stahl, außen  
 extra klares transparentes Glas  
 .16 Innen satinieretes, massives Messing,  
 außen extra klares transparentes Glas

.23 .24 Inside texturized painted steel, outside  
 extra clear transparent glass  
 .16 Inside satin solid brass,  
 outside extra clear transparent glass

ROSETTE  
 .01 .02 .23 .24 Stahl lackiert

CANOPIES  
 .01 .02 .23 .24 Painted steel





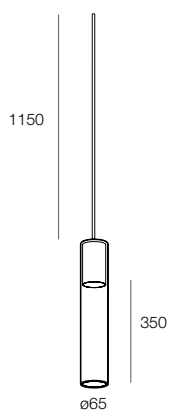

## CRYSTAL

111901. \_\_ 23 24

111901. \_\_ 16

1x GU10 LED max 10W Ø51mm H55mm

### ERFORDERLICHES ZUBEHÖR MANDATORY ACCESSORIES

Rosetten / Canopies

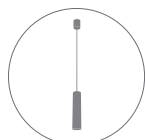

1x für den Aufbau / 1x ceiling

112905. \_\_ 01 02 23 24

Zu kombinieren mit 1 Crystal / To combine with 1 Crystal

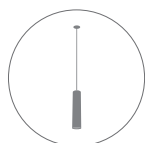

1x für den Einbau / 1x recessed

112906. \_\_ 01 02 23 24

Zu kombinieren mit 1 Crystal / To combine with 1 Crystal

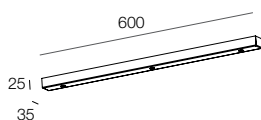

3x für linear / 3x linear

112907. \_\_ 01 02 23 24

Zu kombinieren mit 3 Crystal / To combine with 3 Crystal

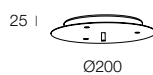

3x für rund / 3x round

112908. \_\_ 01 02 23 24

Zu kombinieren mit 3 Crystal / To combine with 3 Crystal

# CALIMERO

Direkte Hängeleuchten aus hellgrauem oder dunkelgrauem Verbundwerkstoff, mit rückseitigem Diffusorschirm. Aufhängeseile aus schwarzem Kevlar und schwarzem brüniertem Stromkabel.

Direct light suspensions in light grey or dark grey composite material, with backward diffuser screen. Suspension cables made of black Kevlar and black braided power cable.



ROSETTE  
**.23** Lackierter Stahl,  
 hellgrau  
**.24** Lackierter Stahl,  
 dunkelgrau

CANOPY  
**.23** Painted steel,  
 light grey  
**.24** Painted steel,  
 dark grey



KABEL  
 Schwarze Aufhängungen aus Kevlar  
 Schwarzes verbrühtes Stromkabel  
 Einstellbare Länge

CABLES  
 Black Kevlar suspensions  
 Black braided power cable  
 Adjustable length

MAINS

SCHIRM  
**.23** Hellgrauer Verbundstoff, innen hellgrau  
**.24** Dunkelgrauer Verbundstoff, innen hellgrau

SHADE  
**.23** Light grey composite, inside light grey  
**.24** Dark grey composite, inside light grey

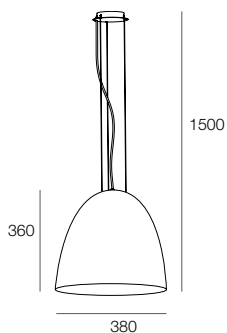

### CALIMERO M



**111702.** \_\_ **23 24**

1x E27 LED max 25W

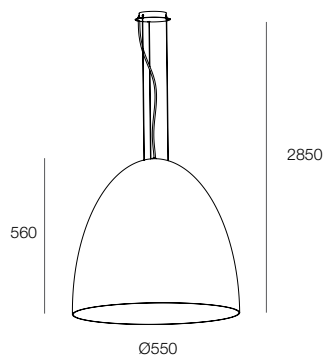

### CALIMERO L



**111703.** \_\_ **23 24**

5x E27 LED max 25W Ø60mm H110mm

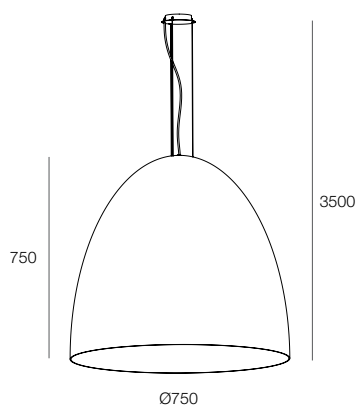

### CALIMERO XL



**111701.** \_\_ **23 24**

7x E27 LED max 25W Ø60mm H110mm



**DECKENLEUCHTEN**  
CEILING

# COLLINS PL

Zylinder für die Aufputzmontage, aus weiß, schwarz, hellgrau oder dunkelgrau lackiertem Stahl oder aus satiniertem, massivem Messing. Durchmesser 40 und 55 mm und Längen 200, 500 und 1000 mm.

Cylinders for surface-mounted installation, in white, black, light grey or dark grey painted steel, or in satin solid brass. Diameters 40 and 55 mm and lengths 200, 500 and 1000 mm.



## COLLINS KOLLEKTION | COLLINS COLLECTION



COLLINS SP  
Pg 20



COLLINS PL  
Pg 32



COLLINS PR  
Pg 54





.01 .02 .23 .24 Texturierter lackierter Stahl  
 .16 Satiniertes, massives Messing

.01 .02 .23 .24 Texturized painted steel  
 .16 Satin solid brass

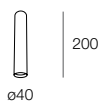

### COLLINS PL Ø40

L 200mm



**111805. \_\_ 01 02 23 24**



**111805. \_\_ 16**

1x GU10 MINI LED max 10W Ø35mm H46mm

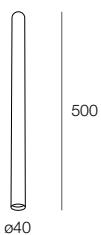

L 500mm



**111806. \_\_ 01 02 23 24**



**111806. \_\_ 16**

1x GU10 MINI LED max 10W Ø35mm H46mm

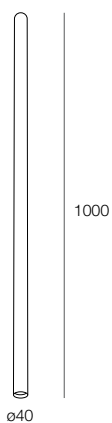

L 1000mm



**111807. \_\_ 01 02 23 24**



**111807. \_\_ 16**

1x GU10 MINI LED max 10W Ø35mm H46mm

# COLLINS PL



.01 .02 .23 .24 Texturierter lackierter Stahl  
 .16 Satiniertes, massives Messing

.01 .02 .23 .24 Texturized painted steel  
 .16 Satin solid brass

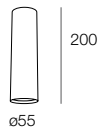

## COLLINS PL Ø55

L 200mm



111808. \_\_ 01 02 23 24



111808. \_\_ 16

1x GU10 LED max 10W Ø51mm H55mm

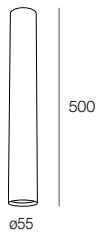

L 500mm



111809. \_\_ 01 02 23 24



111809. \_\_ 16

1x GU10 LED max 10W Ø51mm H55mm

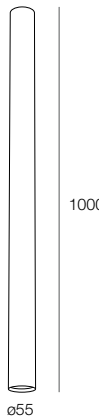

L 1000mm



111810. \_\_ 01 02 23 24



111810. \_\_ 16

1x GU10 LED max 10W Ø51mm H55mm





## OPTIONALES ZUBEHÖR

### OPTIONAL ACCESSORIES

Dekorativer Diffusor / Decorative diffuser

Ø 40mm

**112901.99**

Für Weiß, Schwarz, Dunkelgrau und Hellgrau / For white, black, dark grey and light grey

**112902.99**

Für Messing / For brass



Ø 55mm

**112903.99**

Für Weiß, Schwarz, Dunkelgrau und Hellgrau / For white, black, dark grey and light grey

**112904.99**

Für Messing / For brass

# MISS PL

Aufbauleuchte bestehend aus vertikaler Stange und verstellbarem Gelenkarm mit Lampenfassung, kombinierbar mit Samt- oder Stoffschirm, erhältlich in verschiedenen Ausführungen.

Surface mounted fixture composed of vertical rod and adjustable articulated arm with lamp holder, combinable with velvet or fabric lampshade, available in different finishes.



## MISS KOLLEKTION | MISS COLLECTION



MISS PL  
Pg 36



MISS PR  
Pg 58



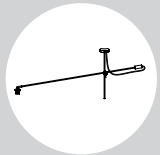

**PRODUKT**  
FIXTURE

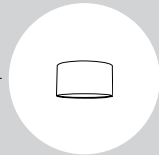

**SCHIRM**  
SHADE



**RAHMEN**  
Lackierter Stahl und  
Stoffkabel  
.01 weiß .02 schwarz

**FRAME**  
Painted steel and  
fabric cable  
.01 white .02 black

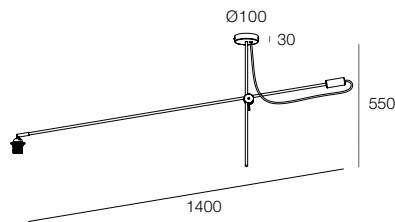

**MISS PL**

111601. \_\_ 01 02

1x E27 LED max 25W

**ERFORDERLICHES ZUBEHÖR**  
MANDATORY ACCESSORIES

Schirm / Shade

112911. \_\_ 25 26

112911. \_\_ 27 28 29

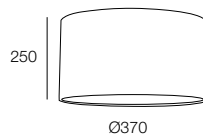

SCHIRM  
.25 Weiße Leine, innen weiß

SHADE  
.25 White canvas, inside white



SCHIRM  
.26 Schwarze Leine, innen gold

SHADE  
.26 Black canvas, inside gold



SCHIRM  
.27 Rosa Samt, innen weiß

SHADE  
.27 Pink velvet, inside white



SCHIRM  
.28 Blauer Samt, innen gold

SHADE  
.28 Blue velvet, inside gold



SCHIRM  
.29 Grüner Samt, innen gold

SHADE  
.29 Green velvet, inside gold

# HONEY PL

Aufbauleuchte mit verstellbaren Spots, die mit einem runden Sockel für einen Spot oder mit linearen Profilen für mehrere Spots kombiniert werden können. Gehäuse aus lackiertem Stahl oder satiniertem, massivem Messing.

Surface mounted installation fixture composed of adjustable spots that can be combined with a circular base for single spot, or with linear profiles for multiple spots. Body in painted steel or satin solid brass.



## HONEY KOLLEKTION | HONEY COLLECTION



HONEY PL  
Pg 38



HONEY IN  
Pg 46



HONEY PR  
Pg 56



HONEY PT  
Pg 64



HONEY TL  
Pg 74



# ERSCHAFFEN SIE IHRE HONEY PL

## CREATE YOUR HONEY PL

**COMBO FARBE:** Wählen Sie den Körper und das Zubehör durch die Kombination von Farben  
**COMBO COLOR:** Choose the body and accessories by combining colors

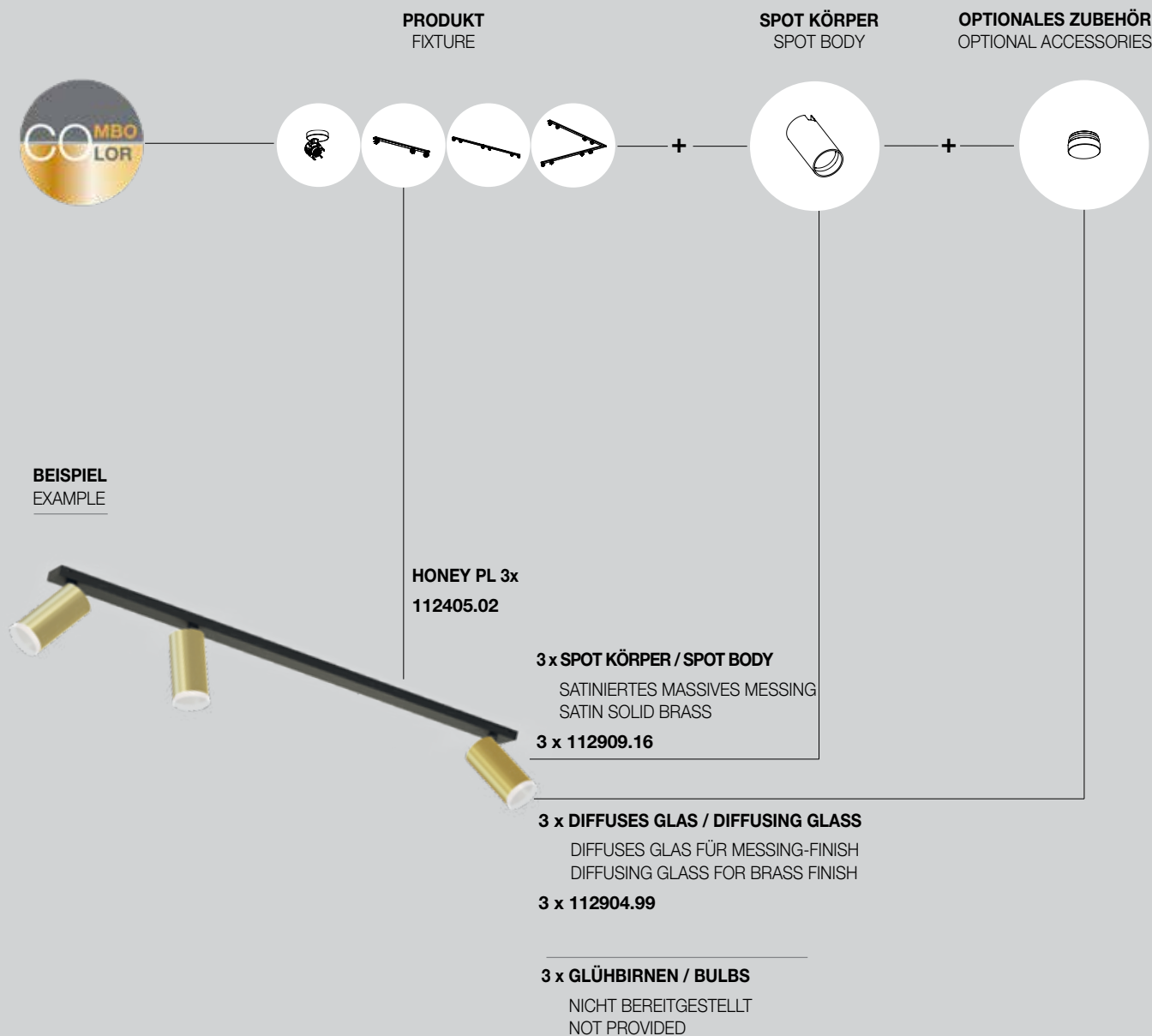

## HONEY PL

MAINS



BASIS  
**.01 .02** Texturierter lackierter Stahl

BASE  
**.01 .02** Texturized painted steel

SPOT  
**.01 .02** Texturierter lackierter Stahl  
**.16** Satiniertes, massives Messing

SPOT  
**.01 .02** Texturized painted steel  
**.16** Satin solid brass

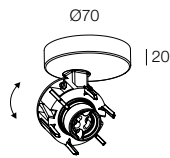

## HONEY PL 1x



**112403.**\_\_ **01 02**

Zu kombinieren mit 1 Spot-Körper / To combine with 1 spot body

1x GU10 LED max 10W Ø51mm H55mm

## HONEY PL 3x



**112405.**\_\_ **01 02**

Zur Kombination mit 3 Spot-Körpern / To combine with 3 spot bodies

3x GU10 LED max 10W Ø51mm H55mm

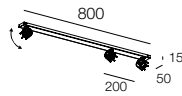

## HONEY PL 6x



**112406.**\_\_ **01 02**

Zur Kombination mit 6 Spot-Körpern / To combine with 6 spot bodies

6x GU10 LED max 10W Ø51mm H55mm

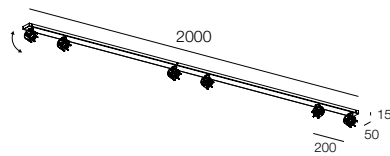

## HONEY PL 8x ANGOLARE / 8x CORNER



**112407.**\_\_ **01 02**

Zur Kombination mit 8 Spot-Körpern / To combine with 8 spot bodies

8x GU10 LED max 10W Ø51mm H55mm

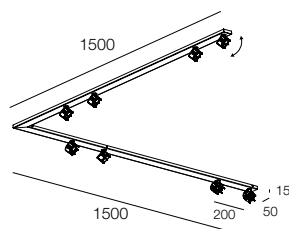

## ERFORDERLICHES ZUBEHÖR MANDATORY ACCESSORIES

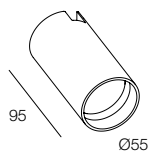

Spot Körper / Spot body



112909. \_\_ 01 02



112909. \_\_ 16

## OPTIONALES ZUBEHÖR OPTIONAL ACCESSORIES

Dekorativer Diffusor / Decorative diffuser



112903.99

Für weiße und schwarze Spots / For white and black spots



112904.99

Für Messing Spot / For brass spot

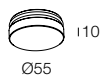

SPOT  
.01 .02 Texturierter lackierter Stahl  
.16 Satiniertes, massives Messing

SPOT  
.01 .02 Texturized painted steel  
.16 Satin solid brass

BASIS  
.01 .02 Texturierter lackierter Stahl

BASIS  
.01 .02 Texturized painted steel

# GECO

IP54-Leuchte für die Aufbaumontage, runde oder quadratische Form. Gehäuse aus weiß oder schwarz lackiertem Aluminium und transparenter Glasscheibe.

IP54 fixture for surface mounted installation, round or square shape. Body made of white or black painted aluminium and transparent glass screen.





MAINS

IP  
54.01 .02 Lackiertes Aluminium,  
Glasscheibe.01 .02 Painted aluminium,  
Glass screen

## GECO RUND / GECO ROUND

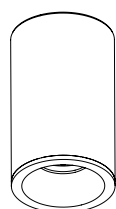
**112001. \_\_ 01 02**
 1x GU10 LED max 10W Ø51mm H55mm



135

Ø85

MAINS

IP  
54.01 .02 Lackiertes Aluminium,  
Glasscheibe.01 .02 Painted aluminium,  
Glass screen

## GECO QUADRATISCH / GECO SQUARE

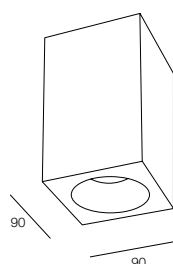
**112002. \_\_ 01 02**
 1x GU10 LED max 10W Ø51mm H55mm

135

90

90



**EINBAULEUCHTEN**  
RECESSED

# HONEY IN

Verstellbarer Strahler aus weiß oder schwarz lackiertem Stahl oder satiniertem, massivem Messing, kombinierbar mit rundem Sockel mit Einbaulampenfassung für die Deckenmontage in Gipskarton.

Adjustable spot made of white or black painted steel or satin solid brass, combinable with circular base with recessed lamp holder for plasterboard ceiling mounting.



## HONEY KOLLEKTION | HONEY COLLECTION



HONEY PL  
Pg 38



HONEY IN  
Pg 46



HONEY PR  
Pg 56



HONEY PT  
Pg 64



HONEY TL  
Pg 74





**PRODUKT**  
FIXTURE



**SPOT KÖRPER**  
SPOT BODY

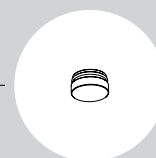

**OPTIONALES ZUBEHÖR**  
OPTIONAL ACCESSORIES



**BASIS**  
.01 .02 Texturierter lackierter  
Stahl

**BASE**  
.01 .02 Texturized painted  
steel

**SPOT**  
.01 .02 Texturierter lackierter Stahl  
.16 Satiniertes, massives Messing

**SPOT**  
.01 .02 Texturized painted steel  
.16 Satin solid brass

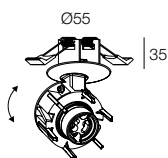

## HONEY IN

112404. \_\_ 01 02

1x GU10 LED max 10W Ø51mm H55mm



## ERFORDERLICHES ZUBEHÖR MANDATORY ACCESSORIES

Spot Körper / Spot body

112909. \_\_ 01 02

112909. \_\_ 16

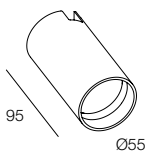

## OPTIONALES ZUBEHÖR OPTIONAL ACCESSORIES

Dekorativer Diffusor / Decorative diffuser

112903.99

Für weiße und schwarze Spots / For white and black spots

112904.99

Für Messing Spot / For brass spot

# MIND

Rundes oder quadratisches IP54-Downlight für den Einbau in Gipskarton- oder sichtbare Gitterrostdecken. Hergestellt aus weiß oder schwarz lackiertem Aluminiumrahmen und transparentem Glas.

Round or square IP54 downlight for recessed installation on plasterboard or exposed grid ceiling. Made of white or black painted aluminium frame and transparent glass.



MAINS IP 54

.01 .02 Lackiertes Aluminium,  
Glasscheibe  
.01 .02 Painted aluminium,  
Glass screen

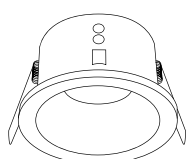
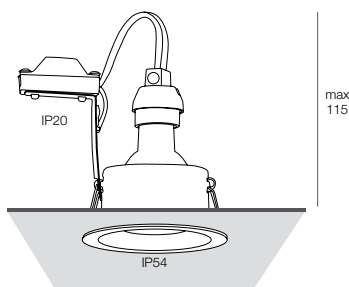

Ø85

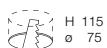

MIND RUND / MIND ROUND

112101. \_\_ 01 02

1x GU10 LED max 10W Ø51mm H55mm

MAINS IP 54

.01 .02 Lackiertes Aluminium,  
Glasscheibe  
.01 .02 Painted aluminium,  
Glass screen

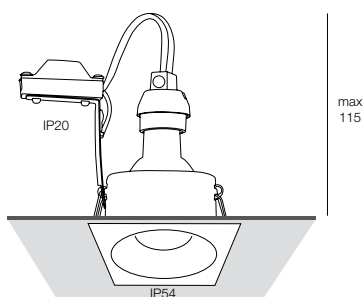

max 115

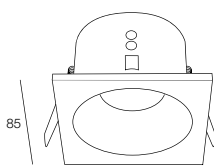

85

85

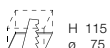

MIND QUADRATISCH / MIND SQUARE

112102. \_\_ 01 02

1x GU10 LED max 10W Ø51mm H55mm



# SPIRIT



Runder Strahler IP54 für den Einbau in Gipskarton- oder sichtbare Rasterdecken. Version mit oder ohne Rahmen für Gipskartondecken, aus weiß oder schwarz lackiertem Aluminium und transparentem Glas.

IP54 round spotlight for recessed installation on plasterboard or exposed grid ceiling. Frame or frameless version for plasterboard ceiling, in white or black painted aluminium and transparent glass.





MAINS IP 54

.01 .02 Lackiertes Aluminium,  
Glasscheibe

.01 .02 Painted aluminium,  
Glass screen

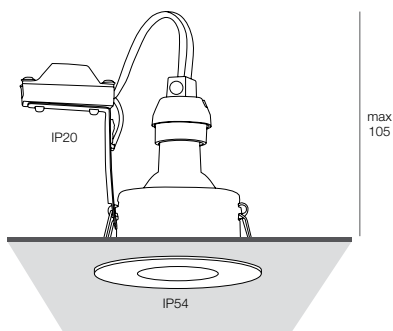

max  
105

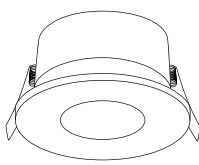

Ø83



SPIRIT RAHMEN / SPIRIT FRAME

112302. \_\_ 01 02

1x GU10 LED max 10W Ø51mm H55mm

MAINS IP 54

.01 .02 Lackiertes Aluminium,  
Glasscheibe

.01 .02 Painted aluminium,  
Glass screen

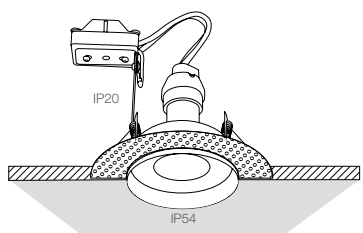

max  
115

125

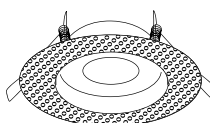

40

75

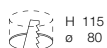

SPIRIT RAHMENLOS / SPIRIT FRAMELESS

112301. \_\_ 01 02

1x GU10 LED max 10W Ø51mm H55mm



# WANDLEUCHTEN

## WALL

# COLLINS PR

Zylinder für die Wandmontage mit direkter und indirekter Abstrahlung, aus weißem, schwarzem, hellgrauem oder dunkelgrauem, strukturlackiertem Stahl oder aus satiniertem, massivem Messing.

Cylinders for wall installation with direct and indirect emission, made of white, black, light grey or dark grey texturized painted steel, or made of satin solid brass.



## COLLINS KOLLEKTION | COLLINS COLLECTION



COLLINS SP  
Pg 20



COLLINS PL  
Pg 32

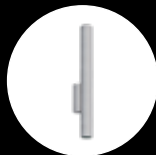

COLLINS PR  
Pg 54



MAINS

.01 .02 .23 .24 Texturierter lackierter Stahl  
 .16 Satiniertes, massives Messing

.01 .02 .23 .24 Texturized painted steel  
 .16 Satin solid brass



### COLLINS PR



111811. \_\_ 01 02 23 24



111811. \_\_ 16

1x GU10 MINI LED max 10W Ø35mm H46mm

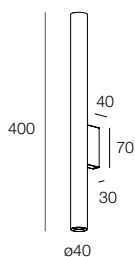

### OPTIONALES ZUBEHÖR OPTIONAL ACCESSORIES

Dekorativer Diffusor / Decorative diffuser

112901.99

Für Weiß, Schwarz, Dunkelgrau und Hellgrau / For white, black, dark grey and light grey

112902.99

Für Messing / For brass

# HONEY PR

Applikation mit verstellbarem Spot aus weiß oder schwarz texturiertem, lackiertem Stahl oder satiniertem, massivem Messing, kombinierbar mit rechteckigem Wandsockel mit Lampenfassung, ausgestattet mit Schalter.

Applique with adjustable spot made of white or black texturized painted steel or satin solid brass, combinable with rectangular wall base with lamp holder, equipped with switch.



## HONEY KOLLEKTION | HONEY COLLECTION



HONEY PL  
Pg 38



HONEY IN  
Pg 46



HONEY PR  
Pg 56



HONEY PT  
Pg 64



HONEY TL  
Pg 74







**PRODUKT**  
FIXTURE



**SPOT KÖRPER**  
SPOT BODY

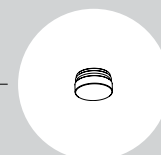

**OPTIONALES ZUBEHÖR**  
OPTIONAL ACCESSORIES

MAINS

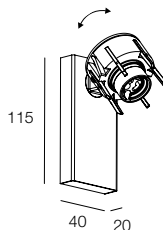
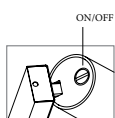

### HONEY PR

112408. \_\_ 01 02

1x GU10 LED max 10W Ø51mm H55mm

### ERFORDERLICHES ZUBEHÖR MANDATORY ACCESSORIES

Spot Körper / Spot body

112909. \_\_ 01 02

112909. \_\_ 16

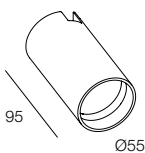

#### SPOT

.01 .02 Texturierter lackierter Stahl  
.16 Satiniertes, massives Messing

#### SPOT

.01 .02 Texturized painted steel  
.16 Satin solid brass

### OPTIONALES ZUBEHÖR OPTIONAL ACCESSORIES

Dekorativer Diffusor / Decorative diffuser

112903.99

Für weiße und schwarze Spots / For white and black spots

112904.99

Für Messing Spot / For brass spot



#### BASIS

.01 .02 Texturierter lackierter Stahl

#### BASE

.01 .02 Texturized painted steel

# MISS PR

Rechteckige Wandleuchte mit direktem und indirektem Streiflicht aus weiß, schwarz, hellgrau oder dunkelgrau lackiertem Stahl, erhältlich in zwei Größen.

Fixture for wall installation composed of adjustable articulated arm with lamp holder, on a base provided with a switch. Combinable with velvet or fabric lampshade, in different finishes.



## MISS KOLLEKTION | MISS COLLECTION



MISS PL  
Pg 36



MISS PR  
Pg 58







**PRODUKT**  
FIXTURE



**SCHIRM**  
SHADE

MAINS



**RAHMEN**  
Lackierter Stahl und  
Stoffkabel  
.01 weiß .02 schwarz

**FRAME**  
Painted steel and  
fabric cable  
.01 white .02 black

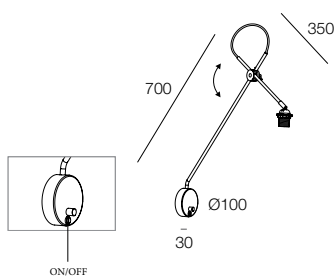

MISS PR



111602. \_\_ 01 02

1x E27 LED max 25W

### ERFORDERLICHES ZUBEHÖR MANDATORY ACCESSORIES

Schirm / Shade



112910. \_\_ 25 26



112910. \_\_ 27 28 29

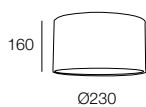

**SCHIRM**  
.25 Weiße Leine, innen weiß  
**SHADE**  
.25 White canvas, inside white



**SCHIRM**  
.26 Schwarze Leine, innen gold  
**SHADE**  
.26 Black canvas, inside gold



**SCHIRM**  
.27 Rosa Samt, innen weiß  
**SHADE**  
.27 Pink velvet, inside white



**SCHIRM**  
.28 Blauer Samt, innen gold  
**SHADE**  
.28 Blue velvet, inside gold



**SCHIRM**  
.29 Grüner Samt, innen gold  
**SHADE**  
.29 Green velvet, inside gold

# CUBRIK

Rechteckige Wandleuchte mit direktem und indirektem Streiflicht aus weiß, schwarz, hellgrau oder dunkelgrau lackiertem Stahl, erhältlich in zwei Größen.

Rectangular wall lamp with direct and indirect grazing light made of white, black, light grey or dark grey painted steel, available in two sizes.



MAINS

.01 .23 .24 Lackierter Stahl

.01 .23 .24 Painted steel

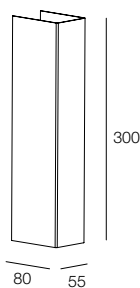

CUBRIK 55

**112502. \_\_ 01 23 24**

2x GU10 LED max 10W Ø51mm H55mm

MAINS

.01 .23 .24 Lackierter Stahl

.01 .23 .24 Painted steel

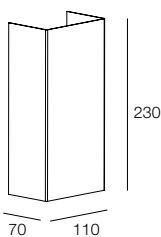

CUBRIK 110

**112501. \_\_ 01 23 24**

2x GU10 LED max 10W Ø51mm H55mm



**STEHLEUCHTEN**  
FLOOR

# HONEY PT

Stehleuchte mit doppeltem Ständer und Lampenfassung auf rechteckigem Sockel, kombinierbar mit verstellbaren Spots aus lackiertem Stahl oder satiniertem, massivem Messing. Fußtaster für Zweifachschaltung.

Floor lamp composed of double stem with lamp holder on a rectangular base, combinable with adjustable spots made of painted steel or satin solid brass. Footswitches for double switch.



## KOLLEKTION HONEY | HONEY COLLECTION



HONEY PL  
Pg 38



HONEY IN  
Pg 46



HONEY PR  
Pg 56



HONEY PT  
Pg 64



HONEY TL  
Pg 74





**PRODUKT**  
FIXTURE



**SPOT KÖRPER**  
SPOT BODY



**OPTIONALES ZUBEHÖR**  
OPTIONAL ACCESSORIES

MAINS

SPOT  
.01 .02 Texturierter lackierter Stahl  
.16 Satiniertes, massives Messing

SPOT  
.01 .02 Texturized painted steel  
.16 Satin solid brass

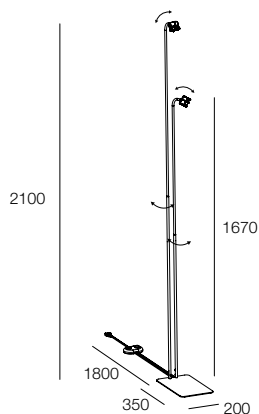

## HONEY PT

112402. \_\_ 01 02

Zur Kombination mit 2 Spotkörpern / To combine with 2 spot bodies

2x GU10 LED max 10W Ø51mm H55mm

## ERFORDERLICHES ZUBEHÖR

MANDATORY ACCESSORIES

Spot Körper / Spot body

112909. \_\_ 01 02

112909. \_\_ 16

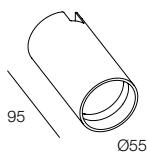

## OPTIONALES ZUBEHÖR

OPTIONAL ACCESSORIES

Dekorativer Diffusor / Decorative diffuser

112903.99

Für weiße und schwarze Spots / For white and black spots

112904.99

Für Messing Spot / For brass spot

RAHMEN  
.01 .02 Stahl lackiert

Fußtaster für Zweifachschaltung

FRAME  
.01 .02 Painted steel

Footswitches for double switch



# TINY PT

Stehleuchte bestehend aus Ständer mit Lampenfassung auf rundem Sockel, kombinierbar mit Schirm aus grünem, blauem oder rosafarbenem Samt, oder aus weiß/weißem oder schwarz/goldenem Stoff. Mit Fußschalter.

Floor lamp composed of stem with lamp holder on round base, combinable with shade in green, blue or pink velvet, or in white/white or black/gold fabric. Foot switch.



## TINY KOLLEKTION | TINY COLLECTION



TINY PT  
Pg 66



TINY TL  
Pg 78





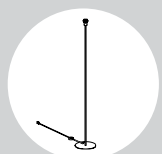

**PRODUKT**  
FIXTURE

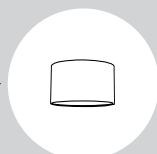

**SCHIRM**  
SHADE

MAINS

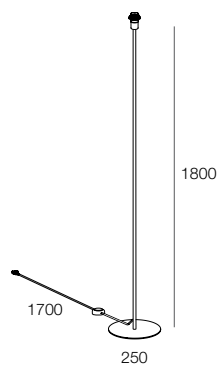

TINY PT



112701. \_\_ 01 02

1x E27 LED max 25W

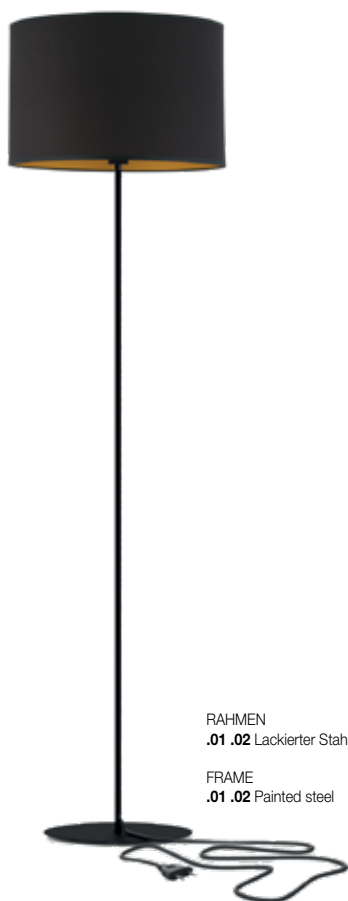

RAHMEN  
.01 .02 Lackierter Stahl

FRAME  
.01 .02 Painted steel

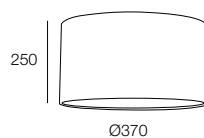

### ERFORDERLICHES ZUBEHÖR MANDATORY ACCESSORIES

Schirm / Shade



112911. \_\_ 25 26



112911. \_\_ 27 28 29



SCHIRM  
.25 Weiße Leine, innen weiß

SHADE  
.25 White canvas, inside white



SCHIRM  
.26 Schwarze Leine, innen gold

SHADE  
.26 Black canvas, inside gold



SCHIRM  
.27 Rosa Samt, innen weiß

SHADE  
.27 Pink velvet, inside white



SCHIRM  
.28 Blauer Samt, innen gold

SHADE  
.28 Blue velvet, inside gold



SCHIRM  
.29 Grüner Samt, innen gold

SHADE  
.29 Green velvet, inside gold

# CHANEL PT

Stehleuchte bestehend aus einem Leuchtenkörper mit drei konvergierenden Beinen mit Lampenfassung und Lampenschirm aus schwarz/goldenem Stoff. Fußschalter.

Floor lamp composed of a support with three converging stems with lamp holder and lampshade in black/gold fabric. Foot switch.



## CHANEL KOLLEKTION | CHANEL COLLECTION



CHANEL PT  
Pg 68



CHANEL TL  
Pg 76



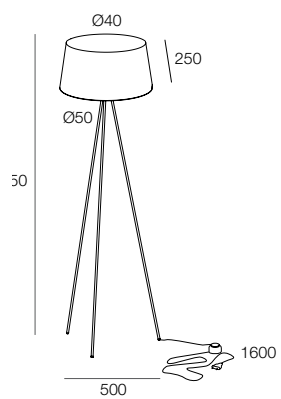

## CHANEL PT

**112601.26**

💡 1x E27 LED max 25W

SCHIRM  
**.26** Schwarze Leine,  
 innen gold

SHADE  
**.26** Black canvas,  
 inside gold

RAHMEN  
 Schwarz lackierter Stahl

FRAME  
 Painted steel black

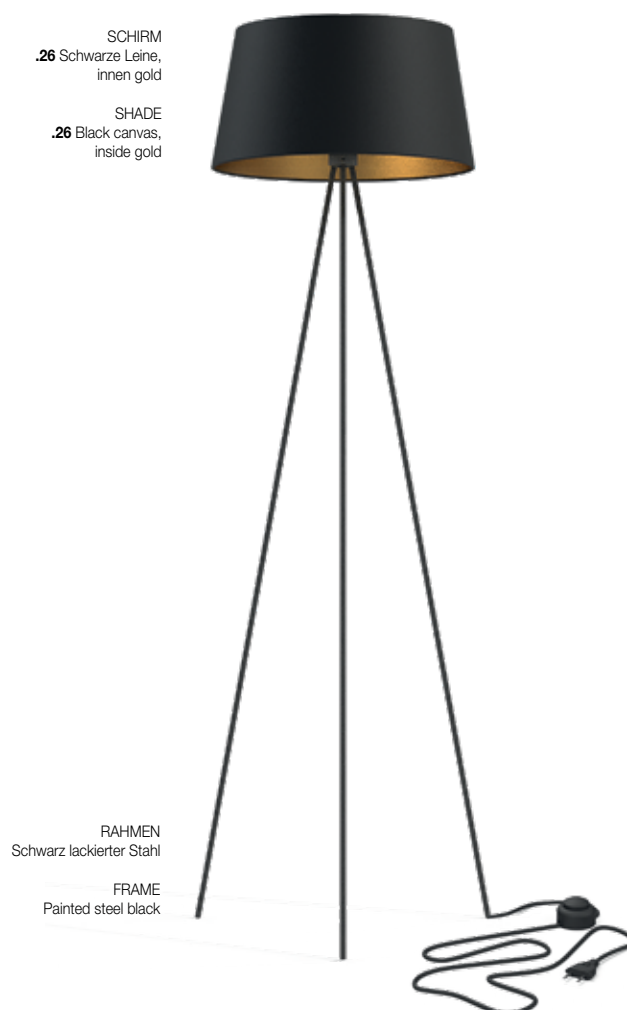

# DIANA

Stehleuchte, bestehend aus einem ausrichtbarem gebogenen Ständer auf einem rechteckigen Sockel, mit Lampenfassung und Lampenschirm aus schwarz/goldenem Stoff. Fußschalter.

Floor lamp composed of curved stem with the possibility of being oriented on a rectangular base, with lamp holder and black/gold fabric lampshade. Foot switch.



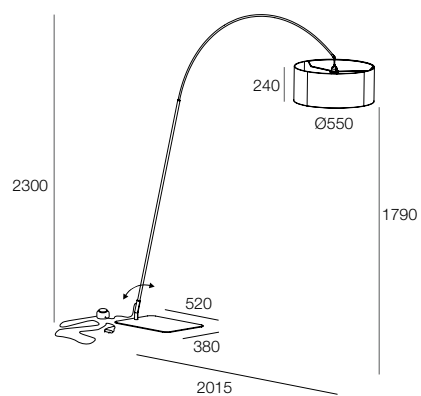

DIANA

**112801.26**

💡 1x E27 LED max 25W

SCHIRM  
**.26** Schwarze Leine,  
 innen gold

SHADE  
**.26** Black canvas,  
 inside gold

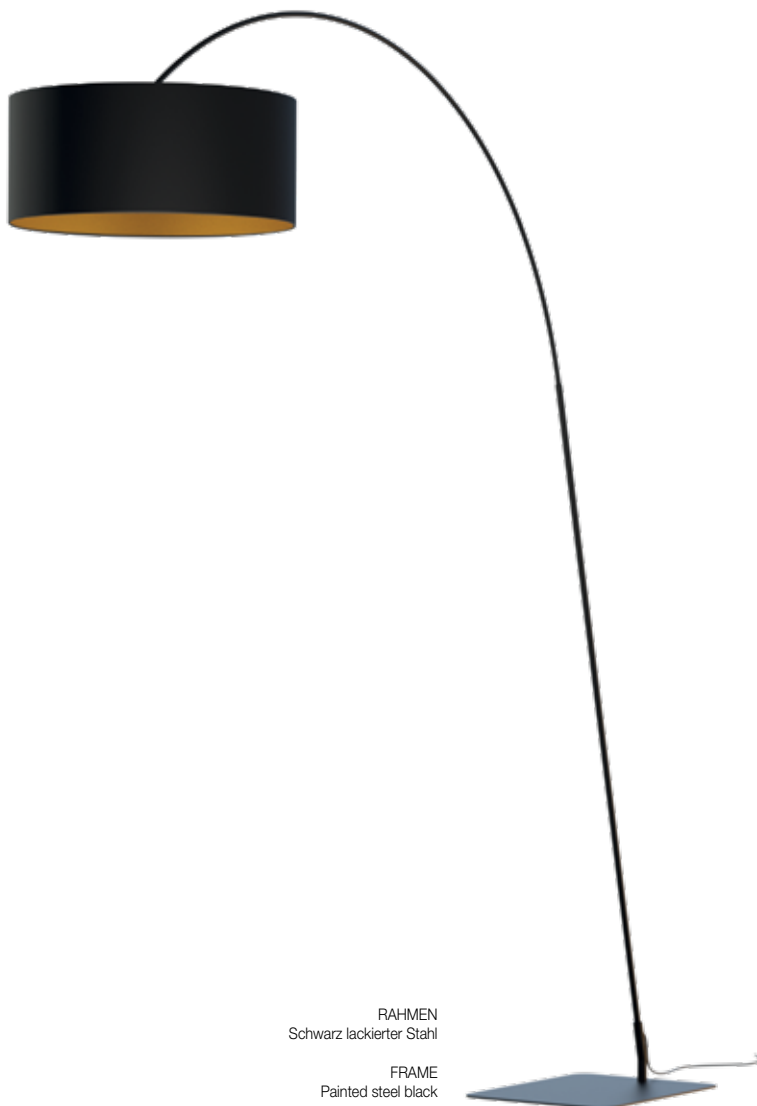

RAHMEN  
 Schwarz lackierter Stahl

FRAME  
 Painted steel black



**TISCHLEUCHTEN**

TABLE

# HONEY TL

Tischleuchte bestehend aus einem Arm auf rundem Sockel, mit Lampenfassung und Schalter, kombinierbar mit einem verstellbaren Strahler aus weiß oder schwarz lackiertem Stahl oder satiniertem, massivem Messing.

Table lamp composed of arm on round base, with lamp holder equipped with switch, combinable with adjustable spot made of white or black textured painted steel or satin solid brass.



## HONEY KOLLEKTION | HONEY COLLECTION



HONEY PL  
Pg 38



HONEY IN  
Pg 46



HONEY PR  
Pg 56



HONEY PT  
Pg 64



HONEY TL  
Pg 74







PRODUKT  
FIXTURE



SPOT KÖRPER  
SPOT BODY

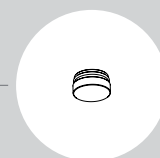

OPTIONALES ZUBEHÖR  
OPTIONAL ACCESSORIES

MAINS

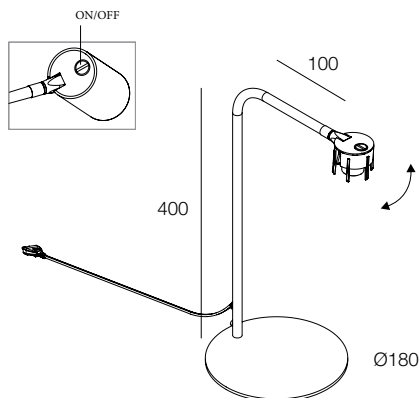

## HONEY TL



112401. \_\_ 01 02

1x GU10 LED max 10W Ø51mm H55mm

## ERFORDERLICHES ZUBEHÖR MANDATORY ACCESSORIES

Spot Körper / Spot body



112909. \_\_ 01 02



112909. \_\_ 16

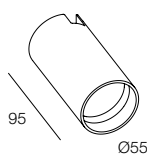

SPOT  
.01 .02 Texturierter lackierter Stahl  
.16 Satiniertes, massives Messing

SPOT  
.01 .02 Texturized painted steel  
.16 Satin solid brass

## OPTIONALES ZUBEHÖR OPTIONAL ACCESSORIES

Dekorativer Diffusor / Decorative diffuser



112903.99

Für weiße und schwarze Spots / For white and black spots



112904.99

Für Messing Spot / For brass spot

KONSTRUKTION  
.01 .02 Lackierter Stahl

STRUCTURE  
.01 .02 Painted steel

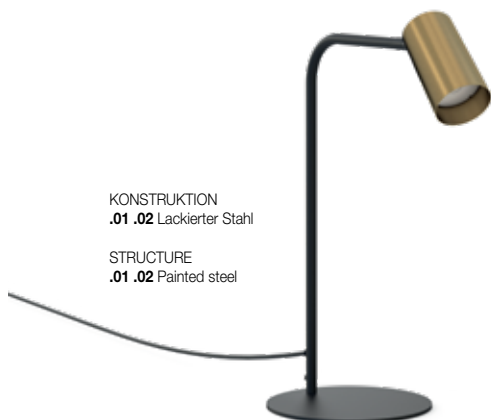

# CHANEL TL

Tischleuchte bestehend aus einem Leuchtenkörper mit drei konvergierenden Beinen mit Lampenfassung und Lampenschirm aus schwarz/goldenem Stoff. Ausgestattet mit Stromkabel mit Schalter.

Table lamp composed of a support with three converging stems with lamp holder and lampshade in black/gold fabric. Equipped with power cable with switch.



## CHANEL KOLLEKTION | CHANEL COLLECTION



CHANEL PT  
Pg 68



CHANEL TL  
Pg 76





SCHIRM  
**.26** Schwarze Leine,  
 innen gold

SHADE  
**.26** Black canvas,  
 inside gold

RAHMEN  
**.01 .02** Lackierter Stahl

FRAME  
**.01 .02** Painted steel

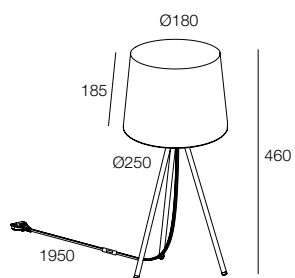

CHANEL TL

**112602. 26**

💡 1x E27 LED max 25W

# TINY TL

Tischleuchte bestehend aus Standfuss mit Lampenfassung auf rundem Sockel, kombinierbar mit einem Schirm aus grünem, blauem oder rosa Samt oder aus weiß/weißem oder schwarz/goldenem Stoff.

Table lamp composed of stem with lamp holder on round base, combinable with shade in green, blue or pink velvet, or in white/white or black/gold fabric.

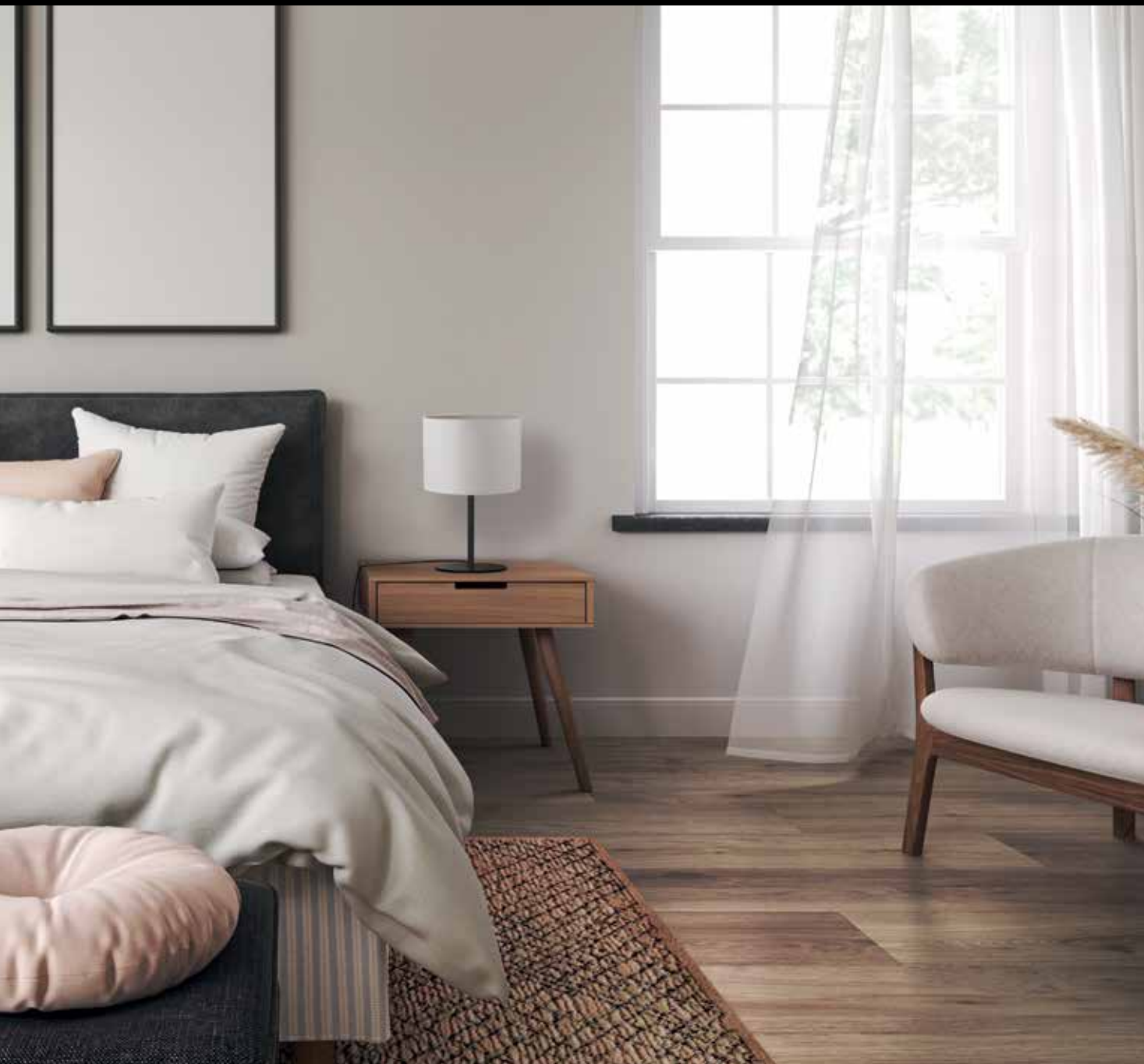

## TINY KOLLEKTION | TINY COLLECTION



TINY PT  
Pg 66



TINY TL  
Pg 78





PRODUKT  
FIXTURE

+

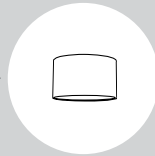

SCHIRM  
SHADE

MAINS

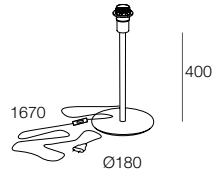

## TINY TL



112702. \_\_ 01 02

1x E27 LED max 25W

## ERFORDERLICHES ZUBEHÖR MANDATORY ACCESSORIES

### Schirm / Shade



112910. \_\_ 25 26



112910. \_\_ 27 28 29

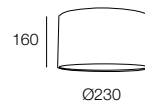

RAHMEN  
.01 .02 Lackierter Stahl

FRAME  
.01 .02 Painted steel



SCHIRM  
.25 Weiße Leine, innen weiß

SHADE  
.25 White canvas, inside white



SCHIRM  
.26 Schwarze Leine, innen gold

SHADE  
.26 Black canvas, inside gold



SCHIRM  
.27 Rosa Samt, innen weiß

SHADE  
.27 Pink velvet, inside white



SCHIRM  
.28 Blauer Samt, innen gold

SHADE  
.28 Blue velvet, inside gold



SCHIRM  
.29 Grüner Samt, innen gold

SHADE  
.29 Green velvet, inside gold

CODE	PG
111601.01	37
111601.02	37
111602.01	59
111602.02	59
111701.23	29
111701.24	29
111702.23	29
111702.24	29
111703.23	29
111703.24	29
111801.01	22
111801.02	22
111801.16	22
111801.23	22
111801.24	22
111802.01	22
111802.02	22
111802.16	22
111802.23	22
111802.24	22
111803.01	22
111803.02	22
111803.16	22
111803.23	22
111803.24	22
111804.01	22
111804.02	22
111804.16	22
111804.23	22
111804.24	22
111805.01	33
111805.02	33
111805.16	33
111805.23	33
111805.24	33
111806.01	33
111806.02	33
111806.16	33
111806.23	33
111806.24	33
111807.01	33
111807.02	33
111807.16	33
111807.23	33
111807.24	33
111808.01	34
111808.02	34
111808.16	34
111808.23	34

CODE	PG
111808.24	34
111809.01	34
111809.02	34
111809.16	34
111809.23	34
111809.24	34
111810.01	34
111810.02	34
111810.16	34
111810.23	34
111810.24	34
111811.01	55
111811.02	55
111811.16	55
111811.23	55
111811.24	55
111901.16	27
111901.23	27
111901.24	27
112001.01	43
112001.02	43
112002.01	43
112002.02	43
112101.01	49
112101.02	49
112102.01	49
112102.02	49
112301.01	51
112301.02	51
112302.01	51
112302.02	51
112401.01	75
112401.02	75
112402.01	65
112402.02	65
112403.01	40
112403.02	40
112404.01	47
112404.02	47
112405.01	40
112405.02	40
112406.01	40
112406.02	40
112407.01	40
112407.02	40
112408.01	57
112408.02	57
112501.01	61
112501.23	61

CODE	PG
112501.24	61
112502.01	61
112502.23	61
112502.24	61
112601.26	69
112602.26	77
112701.01	67
112701.02	67
112702.01	79
112702.02	79
112801.26	71
112901.99	23
112902.99	23
112903.99	23
112904.99	23
112905.01	23
112905.02	23
112905.23	23
112905.24	23
112906.01	23
112906.02	23
112906.23	23
112906.24	23
112907.01	23
112907.02	23
112907.23	23
112907.24	23
112908.01	23
112908.02	23
112908.23	23
112908.24	23
112909.01	41
112909.02	41
112909.16	41
112910.25	59
112910.26	59
112910.27	59
112910.28	59
112910.29	59
112911.25	37
112911.26	37
112911.27	37
112911.28	37
112911.29	37









Dieses Dokument kann technische Ungenauigkeiten oder typografische Fehler enthalten, die nach alleiniger Ermessen von Novalux srl korrigiert werden, sobald sie entdeckt werden. Novalux srl behält sich außerdem das Recht vor, den Inhalt des Dokuments jederzeit ohne vorherige Ankündigung zu ändern. Mit der aktuellen Technik ist es nicht möglich, die genaue Bildqualität von Produkten live darzustellen. Die präsentierten Bilder dienen daher nur zur Veranschaulichung und zu Werbezwecken. Alle in dieser Veröffentlichung enthaltenen Inhalte sowie deren Gestaltung gehören ausschließlich Novalux srl oder verbundenen und/oder kontrollierten Unternehmen und sind durch die Gesetze zum Schutz des geistigen Eigentums und des Urheberrechts geschützt. Es ist daher untersagt, Inhalte ohne Genehmigung zu ändern, zu kopieren, zu reproduzieren, zu verteilen, zu übertragen oder zu verbreiten.

The present document may include some technical inaccuracies or typing errors that will be amended exclusively at novaluxdiscretion as soon as they will be noticed.

Also Novalux srl reserves the right to modify the document contents at any time, without advanced notice.

The actual technology does not allow to display the same exact quality of the product pictures as they appear in reality. These pictures are displayed only for demonstration purpose and for promotional scope.

All the contents present in this publication, including the same graphics, belong exclusively to Novalux srl or to companies associate or subsidiary of Novalux and are protected by the laws inherent the intellectual property rights and the copyright. Therefore it's forbidden modifying, copying, reproducing, distributing, transmitting or disclosing without authorization every own content.

Marzo 2024





