

HERO PLUS

114691.21

novalux
ITALIAN LIGHTING DESIGN SINCE 1948

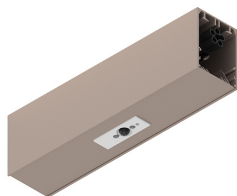

Funcities

Gebruik: Binnenshuis

Type installatie: OPBOUW WAND, INBOUW IN GIPSPLAAT, PENDEL, PLAFOND, RAIL

Kleur: CAPPUCCINO

Dimmen: DALI2

L: 280mm

A: 53mm

H: 69mm

Made in: ITALY

Garantie: 5 jaar

Gewicht: 1.5kg

Technische gegevens

IP: 40

Isolatieklasse: I

SELV: No

[HERO PLUS: Bekijk meer informatie over het product](#)

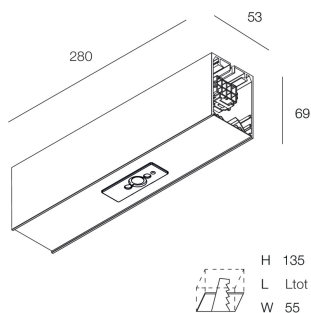

Novalux S.r.l. via Marzabotto, 2 40050 Funo di Argelato (BO) Italy
Tel: +39 051 860558 · Fax +39 051 6647859 · Mail: info@novalux.it · P.IVA 00536541204 · novalux.com
Bedrijf onderworpen aan beheer en coördinatie door SLV GmbH







Dit technische gegevensblad is eigendom van Novalux S.r.l., alle rechten voorbehouden. Novalux S.r.l. behoudt zich het recht voor om zonder voorafgaande kennisgeving wijzigingen aan te brengen.
Laatste update: 29/5/2026, 21:01:14

HERO PLUS

114691.21

novalux
ITALIAN LIGHTING DESIGN SINCE 1948

AANVULLENDE ACCESSOIRES

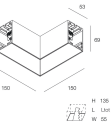
	HERO+: KIT DI GIUNZIONE PROFILI 1PZ	108940.99
	HERO: COPPIA TESTATE CAP	108684.21
	HERO+: MOD.CIECO 280 CAP	114685.21
	HERO+: MOD.CIECO 1120 CAP	114686.21
	HERO+: MOD.CIECO 1400 CAP	114687.21
	HERO+: MOD.CIECO 1680 CAP	114688.21
	HERO+: MOD.CIECO ANG. SX DX 150 CAP	114689.21

MONTAGE ACCESSOIRES

	HERO: SOSPL.3000 1PZ TESTA W.G.ALTO	1086A1.99
	HERO+: SOSP L.3M REGOL. DAL BASSO 1PZ	114694.99
	HERO: KIT INCASSO LED (1X)	108688.99



Novalux S.r.l. via Marzabotto, 2 40050 Funo di Argelato (BO) Italy
Tel: +39 051 860558 · Fax +39 051 6647859 · Mail: info@novalux.it · P.IVA 00536541204 · novalux.com
Bedrijf onderworpen aan beheer en coördinatie door SLV GmbH

Dit technische gegevensblad is eigendom van Novalux S.r.l., alle rechten voorbehouden. Novalux S.r.l. behoudt zich het recht voor om zonder voorafgaande kennisgeving wijzigingen aan te brengen.
Laatste update: 29/5/2026, 21:01:14

HERO PLUS

114691.21

novalux
ITALIAN LIGHTING DESIGN SINCE 1948



HERO: SPESS. CARTONG. 10MM 2PZ.

108689.99



KIT ALIMENTAZIONE L3000 5P BIA

108922.01



KIT ALIMENTAZIONE L3000 5P NE

108922.02



KIT ALIMENTAZIONE L3000 5P CAF

108922.20



KIT ALIMENTAZIONE L3000 5P CAP

108922.21

NOODACCESSOIRES



HERO+: KIT 2 CAVI 1X1.5 EMERGE. L.1400

108941.99



Novalux S.r.l. via Marzabotto, 2 40050 Funo di Argelato (BO) Italy
Tel: +39 051 860558 · Fax +39 051 6647859 · Mail: info@novalux.it · P.IVA 00536541204 · novalux.com
Bedrijf onderworpen aan beheer en coördinatie door SLV GmbH

Dit technische gegevensblad is eigendom van Novalux S.r.l., alle rechten voorbehouden. Novalux S.r.l. behoudt zich het recht voor om zonder voorafgaande kennisgeving wijzigingen aan te brengen.
Laatste update: 29/5/2026, 21:01:14