



Caratteristiche

Uso: Interno
 Tipo installazione: INCASSO
 Colore: BIANCO
 Dimmerazione: 1-10V, 0-10V, DALI, ON/OFF
 Emergenza: NO
 L: 1000mm
 A: 56mm
 H: 36mm
 Garanzia: 5 anni
 Peso: 1.36kg

Dati tecnici







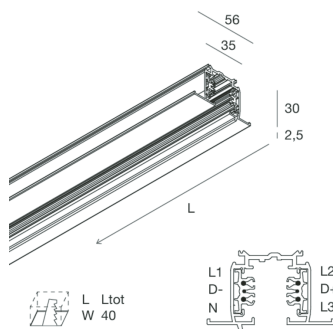



IP: 20
 Classe di isolamento: I
 SELV: No









Conformità

CEI EN 60570/A2:2020

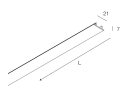

ACCESSORI DI COMPLETAMENTO

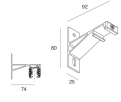
	ALL-TRACK EVO: PINZA CONDUTTORI	106763.99
	ALL-TRACK: COVER CONNETT.LIVE-END BIA	106729.01
	ALL-TRACK: COVER CONNETTORE MIDDLE BIA	106730.01
	ALL-TRACK: COVER CONNETTORE "L" BIA	106731.01
	ALL-TRACK: COVER CONNETTORE "T" BIA	106732.01
	ALL-TRACK: COVER CONNETTORE "X" BIA	106733.01
	ALL-TRACK EVO: TEST.INC. CHIUSURA BI	106762.01
	ALL-TRACK EVO: ALIM.CENTR./GIUNTO BI	106744.01
	ALL-TRACK EVO: ALIM. DI TESTA DX BI	106745.01
	ALL-TRACK EVO: ALIM. DI TESTA SX BI	106746.01
	ALL-TRACK EVO: GIUNTO ELETTR. BI	106747.01

	ALL-TRACK EVO: TESTATA CHIUSURA BI	106748.01
	ALL-TRACK EVO: GIUNTO A X BI	106752.01
	ALL-TRACK EVO: GIUNTO A T INT/EST SX BI	106750.01
	ALL-TRACK EVO: GIUNTO A T INT/EST DX BI	106751.01
	ALL-TRACK EVO: GIUNTO A L INT/EST BI	106749.01
	ALL-TRACK: COPERTURA BINARIO 2M BIANCO	106739.01
ACCESSORI DI MONTAGGIO		
	KIT SOSPENSIONE REG. 2 PZ. BIANCO	106721.01
	ALL-TRACK: FISS.A PLAFONE X BINARIO BIA	106717.01
	ALL-TRACK: STAFFA A PARETE BIANCA	106724.01
	BRIDGE SYSTEM: ADAT. ALL-TRACK ELET/MEC ON/OFF C/MORS B	112922.01
	ALL-TRACK EVO: COPPIA ADATT. 3P BI	106757.01
	ALL-TRACK EVO: COPPIA ADATT. 3P+DALI BI	106758.01





ALL-TRACK EVO: ADATTATORE 3P BI

106755.01



ALL-TRACK EVO: ADATT. 3P+DALI BI

106756.01