

HERO PLUS

114690.21

novalux
ITALIAN LIGHTING DESIGN SINCE 1948



Caractéristiques

Utilisation: Intérieur
Type installation: APPLIQUE MURALE, ENCASTRABLE EN PLAQUE DE PLÂTRE, SUSPENSION, PLAFONNIER, RAIL
Couleur: CAPPUCCINO
Variation: DALI2
L: 280mm
A: 53mm
H: 69mm
Fabriqué en: ITALY
Garantie: 5 ans
Poids: 1.5kg

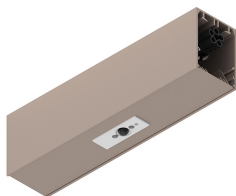

Données techniques

IP: 40
Classe d'isolation: I
Tension d'alimentation: 220-240V 50/60Hz
SELV: No

[HERO PLUS: Voir plus d'informations sur le produit](#)

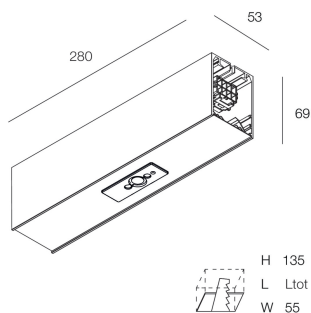

Novalux S.r.l. via Marzabotto, 2 40050 Funo di Argelato (BO) Italie
Tél: +39 051 860558 · Fax +39 051 6647859 · E-mail: info@novalux.it · N° TVA IT00536541204 · novalux.com
Entreprise soumise à la direction et à la coordination de SLV GmbH







Cette fiche technique est la propriété de Novalux S.r.l., tous droits réservés. Novalux S.r.l. se réserve le droit d'apporter des modifications sans préavis.
Dernière actualisation: 29/5/2026, 19:27:21

HERO PLUS



114690.21

novalux
ITALIAN LIGHTING DESIGN SINCE 1948

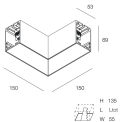
ACCESSOIRES COMPLÉMENTAIRES

	HERO+: KIT DI GIUNZIONE PROFILI 1PZ	108940.99
	HERO: COPPIA TESTATE CAP	108684.21
	HERO+: MOD.CIECO 280 CAP	114685.21
	HERO+: MOD.CIECO 1120 CAP	114686.21
	HERO+: MOD.CIECO 1400 CAP	114687.21
	HERO+: MOD.CIECO 1680 CAP	114688.21
	HERO+: MOD.CIECO ANG. SX DX 150 CAP	114689.21

ACCESSOIRES DE MONTAGE

	HERO: SOSPL.3000 1PZ TESTA W.G.ALTO	1086A1.99
	HERO+: SOSP L.3M REGOLA. DAL BASSO 1PZ	114694.99
	HERO: KIT INCASSO LED (1X)	108688.99



Novalux S.r.l. via Marzabotto, 2 40050 Funo di Argelato (BO) Italie
Tél: +39 051 860558 · Fax +39 051 6647859 · E-mail: info@novalux.it · N° TVA IT00536541204 · novalux.com
Entreprise soumise à la direction et à la coordination de SLV GmbH

Cette fiche technique est la propriété de Novalux S.r.l., tous droits réservés. Novalux S.r.l. se réserve le droit d'apporter des modifications sans préavis.
Dernière actualisation: 29/5/2026, 19:27:21

HERO PLUS

114690.21

novalux
ITALIAN LIGHTING DESIGN SINCE 1948



HERO: SPESS. CARTONG. 10MM 2PZ.

108689.99



KIT ALIMENTAZIONE L3000 5P BIA

108922.01



KIT ALIMENTAZIONE L3000 5P NE

108922.02



KIT ALIMENTAZIONE L3000 5P CAF

108922.20



KIT ALIMENTAZIONE L3000 5P CAP

108922.21

ACCESSOIRES D'URGENCE



HERO+: KIT 2 CAVI 1X1.5 EMERGE. L.1400

108941.99



Novalux S.r.l. via Marzabotto, 2 40050 Funo di Argelato (BO) Italie
Tél: +39 051 860558 · Fax +39 051 6647859 · E-mail: info@novalux.it · N° TVA IT00536541204 · novalux.com
Entreprise soumise à la direction et à la coordination de SLV GmbH

Cette fiche technique est la propriété de Novalux S.r.l., tous droits réservés. Novalux S.r.l. se réserve le droit d'apporter des modifications sans préavis.
Dernière actualisation: 29/5/2026, 19:27:21