



Caractéristiques

Utilisation: Intérieur
Type installation: ENCASTRABLE
Couleur: BLANC
Variation: ON/OFF, 1-10V, 0-10V, DALI
Urgence: NO
L: 3000mm
A: 56mm
H: 36mm
Garantie: 5 ans
Poids: 3.98kg

Données techniques

IP: 20
Classe d'isolation: I







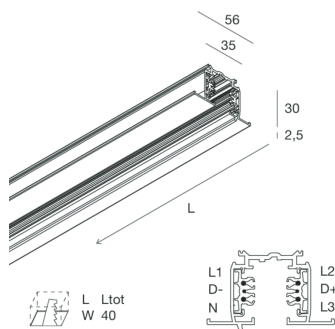



Conformité

CEI EN 60570/A2:2020

[Voir plus d'informations sur le produit](#)



ACCESSOIRES COMPLÉMENTAIRES

	ALL-TRACK: GIUNTO ELETTRIFICATO BIANCO	106707.01
	ALL-TRACK: COVER CONNETT.LIVE-END BIA	106729.01
	ALL-TRACK: COVER CONNETTORE MIDDLE BIA	106730.01
	ALL-TRACK: COVER CONNETTORE "L" BIA	106731.01
	ALL-TRACK: COVER CONNETTORE "T" BIA	106732.01
	ALL-TRACK: COVER CONNETTORE "X" BIA	106733.01
	ALL-TRACK: TESTATA INC. CHIUSURA BIANCA	106734.01
	ALL-TRACK: ALIM. CENTRALE/GIUNTO BIANCO	106704.01
	ALL-TRACK: ALIM. DI TESTA DX BIANCA	106705.01
	ALL-TRACK: ALIM. DI TESTA SX BIANCA	106706.01
	ALL-TRACK: GIUNTO ELETTRIFICATO NERO	106707.02
	ALL-TRACK: TESTATA CHIUSURA BIANCA	106708.01

ALL-TRACK

106727.01

novalux
ITALIAN LIGHTING DESIGN SINCE 1948



Novalux S.r.l. via Marzabotto, 2 40050 Funo di Argelato (BO) Italie
Tél: +39 051 860558 · Fax +39 051 6647859 · E-mail: info@novalux.it · N° TVA IT00536541204 · novalux.com
Entreprise soumise à la direction et à la coordination de SLV GmbH

Cette fiche technique est la propriété de Novalux S.r.l., tous droits réservés. Novalux S.r.l. se réserve le droit d'apporter des modifications sans préavis.
Dernière actualisation: 29/4/2024, 19:15:51



ALL-TRACK: GIUNTO A X BIANCO

106709.01



ALL-TRACK: GIUNTO A T INTERNO SX BIANCO

106710.01



ALL-TRACK: GIUNTO A T INTERNO DX BIANCO

106711.01



ALL-TRACK: GIUNTO A T ESTERNO SX BIANCO

106712.01



ALL-TRACK: GIUNTO A T ESTERNO DX BIANCO

106713.01



ALL-TRACK: GIUNTO A L INTERNO BIANCO

106714.01



ALL-TRACK: GIUNTO A L ESTERNO BIANCO

106715.01



ALL-TRACK: GIUNTO FLESSIBILE BIA

106716.01



ALL-TRACK: ADATTATORE 3P BIANCO

106718.01



ALL-TRACK: ADATT. 3P+DALI BIANCO

106719.01

ACCESSOIRES DE MONTAGE



KIT SOSPENSIONE REG. 2 PZ. BIANCO

106721.01

ALL-TRACK: FISS.A PLAFONE X BINARIO BIA

106717.01



ALL-TRACK

106727.01

novalux

ITALIAN LIGHTING DESIGN SINCE 1948

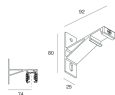

ALL-TRACK: STAFFA A PARETE BIANCA

106724.01



Novalux S.r.l. via Marzabotto, 2 40050 Funo di Argelato (BO) Italie
Tél: +39 051 860558 · Fax +39 051 6647859 · E-mail: info@novalux.it · N° TVA IT00536541204 · novalux.com
Entreprise soumise à la direction et à la coordination de SLV GmbH

Cette fiche technique est la propriété de Novalux S.r.l., tous droits réservés. Novalux S.r.l. se réserve le droit d'apporter des modifications sans préavis.
Dernière actualisation: 29/4/2024, 19:15:51