

ALL-TRACK

106726.01

novalux
ITALIAN LIGHTING DESIGN SINCE 1948



Características

Uso: Interior
Tipo de instalación: EMPOTRABLE
Color: BLANCO
Atenuación: ON/OFF, 1-10V, 0-10V, DALI
Emergencia: NO
L: 2000mm
A: 56mm
H: 36mm
Garantía: 5 años
Peso: 2.657kg

Datos técnicos

IP: 20
Clase de aislamiento: I

Conformidad

CEI EN 60570/A2:2020



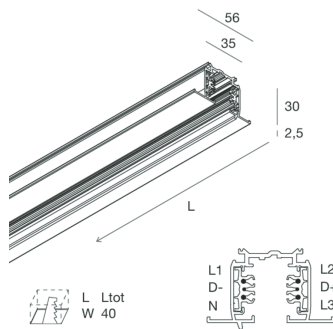







[Ver más información de producto](#)



Novalux S.r.l. via Marzabotto, 2 40050 Funo di Argelato (BO) Italia
Tel: +39 051 860558 · Fax +39 051 6647859 · Correo electrónico: info@novalux.it · Número IVA 00536541204 · novalux.com
Empresa sujeta a la gestión y coordinación de SLV GmbH

Esta ficha de datos técnica es propiedad de Novalux S.r.l., todos los derechos reservados. Novalux S.r.l. se reserva el derecho a efectuar cambios sin aviso previo.
Última actualización: 15/11/2024, 00:45:06

ACCESORIOS ADICIONALES

	ALL-TRACK: GIUNTO ELETTRIFICATO BIANCO	106707.01
	ALL-TRACK: COVER CONNETT.LIVE-END BIA	106729.01
	ALL-TRACK: COVER CONNETTORE MIDDLE BIA	106730.01
	ALL-TRACK: COVER CONNETTORE "L" BIA	106731.01
	ALL-TRACK: COVER CONNETTORE "T" BIA	106732.01
	ALL-TRACK: COVER CONNETTORE "X" BIA	106733.01
	ALL-TRACK: TESTATA INC. CHIUSURA BIANCA	106734.01
	ALL-TRACK: ALIM. CENTRALE/GIUNTO BIANCO	106704.01
	ALL-TRACK: ALIM. DI TESTA DX BIANCA	106705.01
	ALL-TRACK: ALIM. DI TESTA SX BIANCA	106706.01
	ALL-TRACK: GIUNTO ELETTRIFICATO NERO	106707.02
	ALL-TRACK: TESTATA CHIUSURA BIANCA	106708.01

ALL-TRACK











106726.01

novalux
ITALIAN LIGHTING DESIGN SINCE 1948



Novalux S.r.l. via Marzabotto, 2 40050 Funo di Argelato (BO) Italia
Tel: +39 051 860558 · Fax +39 051 6647859 · Correo electrónico: info@novalux.it · Número IVA 00536541204 · novalux.com
Empresa sujeta a la gestión y coordinación de SLV GmbH

Esta ficha de datos técnica es propiedad de Novalux S.r.l., todos los derechos reservados. Novalux S.r.l. se reserva el derecho a efectuar cambios sin aviso previo.
Última actualización: 15/11/2024, 00:45:06

	ALL-TRACK: GIUNTO A X BIANCO	106709.01
	ALL-TRACK: GIUNTO A T INTERNO SX BIANCO	106710.01
	ALL-TRACK: GIUNTO A T INTERNO DX BIANCO	106711.01
	ALL-TRACK: GIUNTO A T ESTERNO SX BIANCO	106712.01
	ALL-TRACK: GIUNTO A T ESTERNO DX BIANCO	106713.01
	ALL-TRACK: GIUNTO A L INTERNO BIANCO	106714.01
	ALL-TRACK: GIUNTO A L ESTERNO BIANCO	106715.01
	ALL-TRACK: GIUNTO FLESSIBILE BIA	106716.01
	ALL-TRACK: ADATTATORE 3P BIANCO	106718.01
	ALL-TRACK: ADATT. 3P+DALI BIANCO	106719.01

ACCESORIOS DE MONTAJE

	KIT SOSPENSIONE REG. 2 PZ. BIANCO	106721.01
	ALL-TRACK: FISS.A PLAFONE X BINARIO BIA	106717.01

ALL-TRACK

106726.01

novalux
ITALIAN LIGHTING DESIGN SINCE 1948

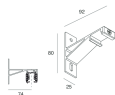

ALL-TRACK: STAFFA A PARETE BIANCA

106724.01



Novalux S.r.l. via Marzabotto, 2 40050 Funo di Argelato (BO) Italia
Tel: +39 051 860558 · Fax +39 051 6647859 · Correo electrónico: info@novalux.it · Número IVA 00536541204 · novalux.com
Empresa sujeta a la gestión y coordinación de SLV GmbH

Esta ficha de datos técnica es propiedad de Novalux S.r.l., todos los derechos reservados. Novalux S.r.l. se reserva el derecho a efectuar cambios sin aviso previo.
Última actualización: 15/11/2024, 00:45:06