

# HERO PLUS C

114859.02

**novalux**  
ITALIAN LIGHTING DESIGN SINCE 1948

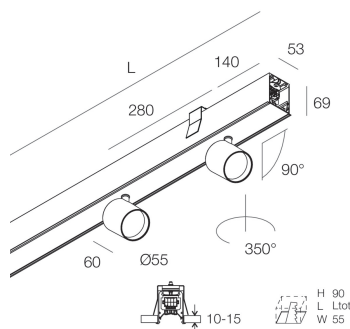

## Features

Use: Indoor  
Type of installation: RECESSED INTO PLASTERBOARD  
Emission: DIRECT  
Optics: SPOT  
Beam: 34°  
Colour: BLACK  
Dimming: DALI2, PUSH  
Emergency: NO  
L: 1120mm  
A: 53mm  
H: 69mm  
Made in: ITALY  
Warranty: 5 years  
Weight: 3.4kg

## Tech data

Luminaire input power: 29W  
Luminaire luminous flux: 2230lm  
IP: 40  
Insulation class: I  
No. of driver per product: 1  
Supply voltage: 220-240V 50/60Hz  
SELV: Si

## Source

Light source: LED  
Source power: 2x13W  
Source luminous flux: 2750lm  
Colour temperature: 3000K  
CRI: >90  
Colour tolerance: 3 Step MacAdam  
LED lifespan: 50000h L90 B10

## Compliance

CEI EN 60598-1:2021 + A11:2023, CEI EN 60598-2-1:2022, CEI EN 60598-2-2:2012

## Standards

Photobiological risk: RISK GROUP 1 Certified fixture in RISK GROUP 1 (Low Risk)-The fixture does not pose a hazard due to normal behavioral limitations on exposure - in accordance with CEI EN 62471:2010-01, IEC TR 62778:2014.

CAM edilizia: CAM edilizia - Conforme al Decreto Ministeriale 23 giugno 2022 n.256 e 24 novembre 2025 n.256.

[HERO PLUS C: View more product info](#)



Novalux S.r.l. via Marzabotto, 2 40050 Funo di Argelato (BO) Italy  
Tel: +39 051 860558 · Fax +39 051 6647859 · Mail: info@novalux.it · VAT number 00536541204 · novalux.com  
Company subject to the management and coordination by SLV GmbH

This technical data sheet is owned by Novalux S.r.l., all rights reserved. Novalux S.r.l. reserves the right to make changes without prior notice.  
Last update: 29/5/2026, 16:26:35

# HERO PLUS C

114859.02

**novalux**  
ITALIAN LIGHTING DESIGN SINCE 1948

## COMPLETION ACCESSORIES

	HERO C: COPPIA TESTATE NE	108860.02
	HERO+C: MOD.CIECO 280 NE	114861.02
	HERO+C: MOD.CIECO 1120 NE	114862.02
	HERO+C: MOD.CIECO 1400 NE	114863.02
	HERO+C: MOD.CIECO 1680 NE	114864.02
	HERO+C: MOD.CIECO ANG.SX DX 150 NE	114865.02



Novalux S.r.l. via Marzabotto, 2 40050 Funo di Argelato (BO) Italy  
Tel: +39 051 860558 · Fax +39 051 6647859 · Mail: info@novalux.it · VAT number 00536541204 · novalux.com  
Company subject to the management and coordination by SLV GmbH

This technical data sheet is owned by Novalux S.r.l., all rights reserved. Novalux S.r.l. reserves the right to make changes without prior notice.  
Last update: 29/5/2026, 16:26:35