

# HERO PLUS B

114764.21

**novalux**  
ITALIAN LIGHTING DESIGN SINCE 1948

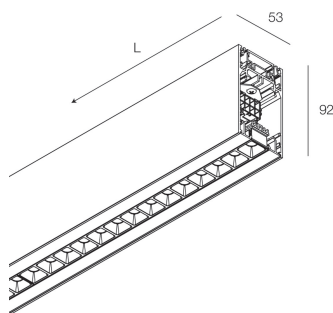
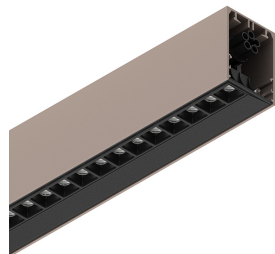

## Features

Use: Indoor  
Type of installation: SUSPENDED  
Emission: DIRECT/INDIRECT  
Optics: MICRO OPTICS  
Colour: CAPPUCCINO  
Dimming: DALI2, PUSH  
Emergency: NO  
L: 1400mm  
A: 53mm  
H: 92mm  
Made in: ITALY  
Warranty: 5 years  
Weight: 5kg

## Tech data

Luminaire input power: 69,5W  
Luminaire luminous flux: 6345lm  
Direct luminous flux: 3410lm  
Indirect luminous flux: 2935lm  
IP: 40  
Insulation class: I  
No. of driver per product: 2  
Supply voltage: 220-240V 50/60Hz  
UGR: <19  
SELV: Si

## Source

Light source: LED  
Source power: 63W  
Source luminous flux: 4145lm  
Colour temperature: 2700K  
CRI: >90  
Colour tolerance: 3 Step MacAdam  
LED lifespan: 50000h L90 B10

## Compliance

CEI EN 60598-1:2021 + A11:2023, CEI EN 60598-2-1:2022

## Standards

Photobiological risk: RISK GROUP 0 Certified fixture in EXEMPT GROUP, in accordance with CEI EN 62471:2010-01, IEC TR 62778:2014.

CAM edilizia: CAM edilizia - Conforme al Decreto Ministeriale 23 giugno 2022 n.256 e 24 novembre 2025 n.256.

## Average luminance

Average luminance limits for DSE workstation 65°(in accordance to EN 12464-1:2012).

[HERO PLUS B: View more product info](#)



Novalux S.r.l. via Marzabotto, 2 40050 Funo di Argelato (BO) Italy  
Tel: +39 051 860558 · Fax +39 051 6647859 · Mail: info@novalux.it · VAT number 00536541204 · novalux.com  
Company subject to the management and coordination by SLV GmbH



This technical data sheet is owned by Novalux S.r.l., all rights reserved. Novalux S.r.l. reserves the right to make changes without prior notice.  
Last update: 29/5/2026, 16:25:59

# HERO PLUS B



114764.21

**novalux**  
ITALIAN LIGHTING DESIGN SINCE 1948

## COMPLETION ACCESSORIES

	HERO+: KIT DI GIUNZIONE PROFILI 1PZ	108940.99
	HERO B: COPPIA TESTATE CAP	1087B1.21
	HERO+B: MOD.CIECO 280 CAP	114785.21
	HERO+B: MOD.CIECO 1120 CAP	114786.21
	HERO+B: MOD.CIECO 1400 CAP	114787.21
	HERO+B: MOD.CIECO 1680 CAP	114788.21
	HERO+B: MOD.CIECO ANG. SX DX 150 CAP	114789.21

## MOUNTING ACCESSORIES

	KIT SOSPENSIONE HERO+B/MINI B L.1.2M 2PZ	114794.99
	KIT SOSPENSIONE HERO+B/MINI B L. 3M 2PZ	114795.99
	KIT SOSPENSIONE HERO+B/MINI B L.1.2M 3PZ	114796.99



Novalux S.r.l. via Marzabotto, 2 40050 Funo di Argelato (BO) Italy  
Tel: +39 051 860558 · Fax +39 051 6647859 · Mail: info@novalux.it · VAT number 00536541204 · novalux.com  
Company subject to the management and coordination by SLV GmbH

This technical data sheet is owned by Novalux S.r.l., all rights reserved. Novalux S.r.l. reserves the right to make changes without prior notice.  
Last update: 29/5/2026, 16:25:59

# HERO PLUS B

114764.21

**novalux**  
ITALIAN LIGHTING DESIGN SINCE 1948



KIT SOSPENSIONE HERO+B/MINI B L. 3M 3PZ

**114797.99**



KIT ALIMENTAZIONE L3000 3P CAP

**108920.21**



KIT ALIMENTAZIONE L3000 5P CAP

**108922.21**

## EMERGENCY ACCESSORIES



HERO+: KIT 2 CAVI 1X1.5 EMERGE. L.1400

**108941.99**



Novalux S.r.l. via Marzabotto, 2 40050 Funo di Argelato (BO) Italy  
Tel: +39 051 860558 · Fax +39 051 6647859 · Mail: info@novalux.it · VAT number 00536541204 · novalux.com  
Company subject to the management and coordination by SLV GmbH

This technical data sheet is owned by Novalux S.r.l., all rights reserved. Novalux S.r.l. reserves the right to make changes without prior notice.  
Last update: 29/5/2026, 16:25:59