

# HERO PLUS

114690.01

**novalux**  
ITALIAN LIGHTING DESIGN SINCE 1948



## Features

Use: Indoor  
Type of installation: WALL, RECESSED INTO PLASTERBOARD, SUSPENDED, CEILING MOUNTED, TRACK  
Colour: WHITE  
Dimming: DALI2  
L: 280mm  
A: 53mm  
H: 69mm  
Made in: ITALY  
Warranty: 5 years  
Weight: 1.5kg

## Tech data

IP: 40  
Insulation class: I  
Supply voltage: 220-240V 50/60Hz  
SELV: No

[HERO PLUS: View more product info](#)

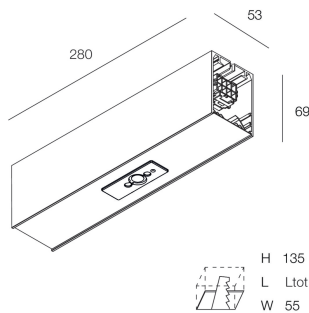

Novalux S.r.l. via Marzabotto, 2 40050 Funo di Argelato (BO) Italy  
Tel: +39 051 860558 · Fax +39 051 6647859 · Mail: info@novalux.it · VAT number 00536541204 · novalux.com  
Company subject to the management and coordination by SLV GmbH







This technical data sheet is owned by Novalux S.r.l., all rights reserved. Novalux S.r.l. reserves the right to make changes without prior notice.  
Last update: 29/5/2026, 16:25:49

# HERO PLUS



114690.01

**novalux**  
ITALIAN LIGHTING DESIGN SINCE 1948

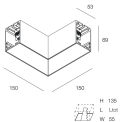
## COMPLETION ACCESSORIES

	HERO+: KIT DI GIUNZIONE PROFILI 1PZ	108940.99
	HERO: COPPIA TESTATE BIA	108684.01
	HERO+: MOD.CIECO 280 BIA	114685.01
	HERO+: MOD.CIECO 1120 BIA	114686.01
	HERO+: MOD.CIECO 1400 BIA	114687.01
	HERO+: MOD.CIECO 1680 BIA	114688.01
	HERO+: MOD.CIECO ANG. SX DX 150 BIA	114689.01

## MOUNTING ACCESSORIES

	HERO: SOSPL.3000 1PZ TESTA W.G.ALTO	1086A1.99
	HERO+: SOSP L.3M REGOLA. DAL BASSO 1PZ	114694.99
	HERO: KIT INCASSO LED (1X)	108688.99



Novalux S.r.l. via Marzabotto, 2 40050 Funo di Argelato (BO) Italy  
Tel: +39 051 860558 · Fax +39 051 6647859 · Mail: info@novalux.it · VAT number 00536541204 · novalux.com  
Company subject to the management and coordination by SLV GmbH

This technical data sheet is owned by Novalux S.r.l., all rights reserved. Novalux S.r.l. reserves the right to make changes without prior notice.  
Last update: 29/5/2026, 16:25:49

# HERO PLUS

114690.01

**novalux**  
ITALIAN LIGHTING DESIGN SINCE 1948



HERO: SPESS. CARTONG. 10MM 2PZ.

**108689.99**



KIT ALIMENTAZIONE L3000 5P BIA

**108922.01**



KIT ALIMENTAZIONE L3000 5P NE

**108922.02**



KIT ALIMENTAZIONE L3000 5P CAF

**108922.20**



KIT ALIMENTAZIONE L3000 5P CAP

**108922.21**

## EMERGENCY ACCESSORIES



HERO+: KIT 2 CAVI 1X1.5 EMERGE. L.1400

**108941.99**



Novalux S.r.l. via Marzabotto, 2 40050 Funo di Argelato (BO) Italy  
Tel: +39 051 860558 · Fax +39 051 6647859 · Mail: info@novalux.it · VAT number 00536541204 · novalux.com  
Company subject to the management and coordination by SLV GmbH

This technical data sheet is owned by Novalux S.r.l., all rights reserved. Novalux S.r.l. reserves the right to make changes without prior notice.  
Last update: 29/5/2026, 16:25:49