

# HERO PLUS

114680.01

**novalux**  
ITALIAN LIGHTING DESIGN SINCE 1948

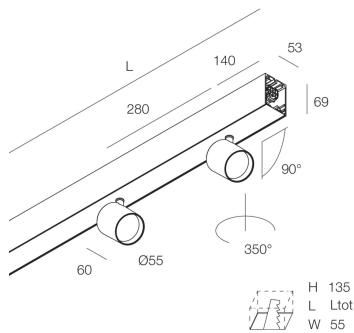

## Features

Use: Indoor  
Type of installation: WALL, RECESSED INTO PLASTERBOARD, SUSPENDED, CEILING MOUNTED, TRACK  
Emission: DIRECT  
Optics: SPOT  
Beam: 14°  
Colour: WHITE  
Dimming: DALI2, PUSH  
Emergency: NO  
L: 1120mm  
A: 53mm  
H: 69mm  
Made in: ITALY  
Warranty: 5 years  
Weight: 3.4kg

## Tech data

Luminaire input power: 29W  
Luminaire luminous flux: 2110lm  
IP: 40  
Insulation class: I  
No. of driver per product: 1  
Supply voltage: 220-240V 50/60Hz  
SELV: Si

## Source

Light source: LED  
Source power: 2x13W  
Source luminous flux: 2750lm  
Colour temperature: 3000K  
CRI: >90  
Colour tolerance: 3 Step MacAdam  
LED lifespan: 50000h L90 B10

## Compliance

CEI EN 60598-1:2021 + A11:2023, CEI EN 60598-2-1:2022, CEI EN 60598-2-2:2012

## Standards

Photobiological risk: RISK GROUP 1 Certified fixture in RISK GROUP 1 (Low Risk)-The fixture does not pose a hazard due to normal behavioral limitations on exposure - in accordance with CEI EN 62471:2010-01, IEC TR 62778:2014.

CAM edilizia: CAM edilizia - Conforme al Decreto Ministeriale 23 giugno 2022 n.256 e 24 novembre 2025 n.256.

[HERO PLUS: View more product info](#)



Novalux S.r.l. via Marzabotto, 2 40050 Funo di Argelato (BO) Italy  
Tel: +39 051 860558 · Fax +39 051 6647859 · Mail: info@novalux.it · VAT number 00536541204 · novalux.com  
Company subject to the management and coordination by SLV GmbH







This technical data sheet is owned by Novalux S.r.l., all rights reserved. Novalux S.r.l. reserves the right to make changes without prior notice.  
Last update: 29/5/2026, 16:25:25

# HERO PLUS

114680.01

**novalux**  
ITALIAN LIGHTING DESIGN SINCE 1948

## COMPLETION ACCESSORIES

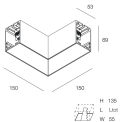
	HERO+: KIT DI GIUNZIONE PROFILI 1PZ	108940.99
	HERO: COPPIA TESTATE BIA	108684.01
	HERO+: MOD.CIECO 280 BIA	114685.01
	HERO+: MOD.CIECO 1120 BIA	114686.01
	HERO+: MOD.CIECO 1400 BIA	114687.01
	HERO+: MOD.CIECO 1680 BIA	114688.01
	HERO+: MOD.CIECO ANG. SX DX 150 BIA	114689.01

## MOUNTING ACCESSORIES

	HERO: SOSP.L3000 1PZ TESTA W.G.ALTO	1086A1.99
	HERO+: SOSP L.3M REGOLA. DAL BASSO 1PZ	114694.99
	ALL-TRACK EVO: COPPIA ADATT. 3P BI	106757.01



Novalux S.r.l. via Marzabotto, 2 40050 Funo di Argelato (BO) Italy  
Tel: +39 051 860558 · Fax +39 051 6647859 · Mail: info@novalux.it · VAT number 00536541204 · novalux.com  
Company subject to the management and coordination by SLV GmbH

This technical data sheet is owned by Novalux S.r.l., all rights reserved. Novalux S.r.l. reserves the right to make changes without prior notice.  
Last update: 29/5/2026, 16:25:25

# HERO PLUS

114680.01

**novalux**  
ITALIAN LIGHTING DESIGN SINCE 1948



ALL-TRACK EVO: COPPIA ADATT. 3P NE

**106757.02**



ALL-TRACK EVO: COPPIA ADATT. 3P+DALI BI

**106758.01**



ALL-TRACK EVO: COPPIA ADATT. 3P+DALI NE

**106758.02**



HERO: KIT INCASSO LED (1X)

**108688.99**



HERO: SPESS. CARTONG. 10MM 2PZ.

**108689.99**



KIT ALIMENTAZIONE L3000 5P BIA

**108922.01**



KIT ALIMENTAZIONE L3000 5P NE

**108922.02**



KIT ALIMENTAZIONE L3000 5P CAF

**108922.20**



KIT ALIMENTAZIONE L3000 5P CAP

**108922.21**

## EMERGENCY ACCESSORIES



HERO+: KIT 2 CAVI 1X1.5 EMERGE. L.1400

**108941.99**



Novalux S.r.l. via Marzabotto, 2 40050 Funo di Argelato (BO) Italy  
Tel: +39 051 860558 · Fax +39 051 6647859 · Mail: info@novalux.it · VAT number 00536541204 · novalux.com  
Company subject to the management and coordination by SLV GmbH

This technical data sheet is owned by Novalux S.r.l., all rights reserved. Novalux S.r.l. reserves the right to make changes without prior notice.  
Last update: 29/5/2026, 16:25:25