

# HERO B

108779.01 + 108925.99

HERO B: 67W 3K 1680 PUSH BIA + HERO: DIFF. OPALE TL PER 1680



**novalux**  
ITALIAN LIGHTING DESIGN SINCE 1948

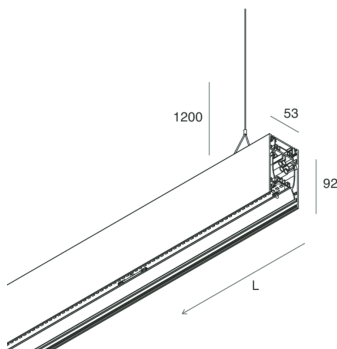
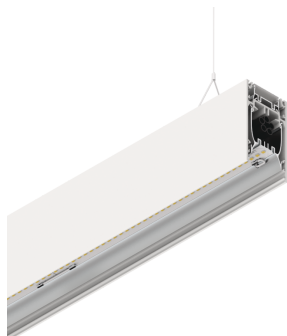

## Features

Use: Indoor  
Type of installation: SUSPENDED  
Emission: DIRECT/INDIRECT  
Optics: OPAL FULL LIGHT  
Colour: WHITE  
Dimming: PUSH  
Emergency: NO  
L: 1680mm  
A: 53mm  
H: 92mm  
Made in: ITALY  
Warranty: 5 years  
Weight: 6kg

## Tech data

Luminaire input power: 74.9W  
Luminaire luminous flux: 6790lm  
Indirect luminous flux: 3537lm  
IP: 40  
Insulation class: I  
No. of driver per product: 2  
Supply voltage: 220-240V 50/60Hz  
SELV: Si

## Source

Light source: LED  
Source power: 67W  
Colour temperature: 3000K  
CRI: >90  
Colour tolerance: 3 Step MacAdam  
LED lifespan: 50000h L90 B10

## Compliance

CEI EN 60598-1:2021 + A11:2023, CEI EN 60598-2-1:2022

## Standards

Photobiological risk: RISK GROUP 0 Certified fixture in EXEMPT GROUP, in accordance with CEI EN 62471:2010-01, IEC TR 62778:2014.  
CAM edilizia: CAM edilizia - Conforme al Decreto Ministeriale 23 giugno 2022 n.256 e 24 novembre 2025 n.256.

[HERO B: View more product info](#)



Novalux S.r.l. via Marzabotto, 2 40050 Funo di Argelato (BO) Italy  
Tel: +39 051 860558 · Fax +39 051 6647859 · Mail: info@novalux.it · VAT number 00536541204 · novalux.com  
Company subject to the management and coordination by SLV GmbH

This technical data sheet is owned by Novalux S.r.l., all rights reserved. Novalux S.r.l. reserves the right to make changes without prior notice.  
Last update: 29/5/2026, 17:46:29

# HERO B

108779.01 + 108925.99

HERO B: 67W 3K 1680 PUSH BIA + HERO: DIFF. OPALE TL PER 1680

**novalux**  
ITALIAN LIGHTING DESIGN SINCE 1948



## Features

Optics: OPAL FULL LIGHT

L: 1680mm

A: 52.5mm

H: 15mm

Made in: ITALY

Warranty: 5 years

Weight: 0.13kg

## Tech data

IP: 40

SELV: No



Novalux S.r.l. via Marzabotto, 2 40050 Funo di Argelato (BO) Italy  
Tel: +39 051 860558 · Fax +39 051 6647859 · Mail: info@novalux.it · VAT number 00536541204 · novalux.com  
Company subject to the management and coordination by SLV GmbH

This technical data sheet is owned by Novalux S.r.l., all rights reserved. Novalux S.r.l. reserves the right to make changes without prior notice.  
Last update: 29/5/2026, 17:46:29











# HERO B

108779.01 + 108925.99

HERO B: 67W 3K 1680 PUSH BIA + HERO: DIFF. OPALE TL PER 1680

**novalux**  
ITALIAN LIGHTING DESIGN SINCE 1948

## COMPLETION ACCESSORIES

	HERO B: MOD.CIECO ANG.DX 150 BIA	<b>1087A5.01</b>
	HERO B: MOD.CIECO 250 BIA	<b>1087A3.01</b>
	HERO B: MOD.CIECO 1680 BIA	<b>1087A8.01</b>
	HERO: TESTATA OPALE PER SCHERMO TL 2PZ	<b>108930.99</b>
	HERO B: MOD.CIECO 1400 BIA	<b>1087A7.01</b>
	HERO B: MOD.CIECO ANG.SX 150 BIA	<b>1087A4.01</b>
	HERO B: COPPIA TESTATE BIA	<b>1087B1.01</b>
	HERO B: MOD.CIECO 1120 BIA	<b>1087A6.01</b>
<h2>MOUNTING ACCESSORIES</h2>		
	HERO B: KIT COPPIA CAVI SOSP. 5 M	<b>1087B2.99</b>
	KIT ALIMENTAZIONE L1200 5P BIA	<b>108921.01</b>



Novalux S.r.l. via Marzabotto, 2 40050 Funo di Argelato (BO) Italy  
Tel: +39 051 860558 · Fax +39 051 6647859 · Mail: info@novalux.it · VAT number 00536541204 · novalux.com  
Company subject to the management and coordination by SLV GmbH

This technical data sheet is owned by Novalux S.r.l., all rights reserved. Novalux S.r.l. reserves the right to make changes without prior notice.  
Last update: 29/5/2026, 17:46:29

# HERO B

108779.01 + 108925.99

HERO B: 67W 3K 1680 PUSH BIA + HERO: DIFF. OPALE TL PER 1680

**novalux**  
ITALIAN LIGHTING DESIGN SINCE 1948



KIT ALIMENTAZIONE L3000 5P BIA

**108922.01**



Novalux S.r.l. via Marzabotto, 2 40050 Funo di Argelato (BO) Italy  
Tel: +39 051 860558 · Fax +39 051 6647859 · Mail: [info@novalux.it](mailto:info@novalux.it) · VAT number 00536541204 · [novalux.com](http://novalux.com)  
Company subject to the management and coordination by SLV GmbH

This technical data sheet is owned by Novalux S.r.l., all rights reserved. Novalux S.r.l. reserves the right to make changes without prior notice.  
Last update: 29/5/2026, 17:46:29