

HERO B

108732.21

novalux
ITALIAN LIGHTING DESIGN SINCE 1948

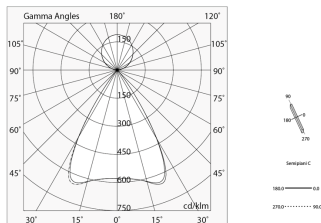
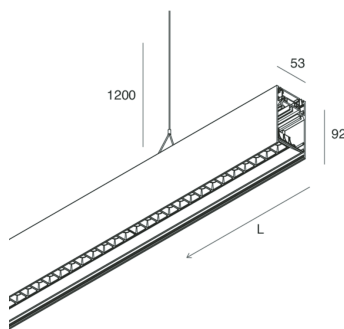
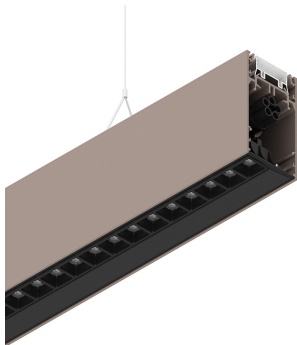

Features

Use: Indoor
Type of installation: SUSPENDED
Emission: DIRECT/INDIRECT
Optics: MICRO OPTICS
Colour: CAPPUCCINO
Dimming: ON/OFF
Emergency: NO
L: 1428mm
A: 53mm
H: 92mm
Made in: ITALY
Warranty: 5 years
Weight: 5kg

Tech data

Luminaire input power: 69W
Luminaire luminous flux: 6468lm
Direct luminous flux: 3638lm
Indirect luminous flux: 2830lm
IP: 40
Insulation class: I
No. of driver per product: 2
Supply voltage: 220-240V 50/60Hz
UGR: <19
SELV: Si

Source

Light source: LED
Source power: 61W
Colour temperature: 3000K
CRI: >90
Colour tolerance: 3 Step MacAdam
LED lifespan: 50000h L80 B20

Compliance

CEI EN 60598-1:2021 + A11:2023, CEI EN 60598-2-1:2022

Standards

Photobiological risk: RISK GROUP 0 Certified fixture in EXEMPT GROUP, in accordance with CEI EN 62471:2010-01, IEC TR 62778:2014.
CAM edilizia: The product complies with the requirements for public buildings, ministerial decree of 23rd June 2022 n.256.

Average luminance

Average luminance limits for DSE workstation 65°(in accordance to EN 12464-1:2012).

[View more product info](#)



Novalux S.r.l. via Marzabotto, 2 40050 Funo di Argelato (BO) Italy
Tel: +39 051 860558 · Fax +39 051 6647859 · Mail: info@novalux.it · VAT number 00536541204 · novalux.com
Company subject to the management and coordination by SLV GmbH







This technical data sheet is owned by Novalux S.r.l., all rights reserved. Novalux S.r.l. reserves the right to make changes without prior notice.
Last update: 14/11/2024, 18:44:53

HERO B

108732.21

novalux
ITALIAN LIGHTING DESIGN SINCE 1948

COMPLETION ACCESSORIES

	HERO B: MOD.CIECO 250 CAP	1087A3.21
	HERO B: MOD.CIECO ANG.SX 150 CAP	1087A4.21
	HERO B: MOD.CIECO ANG.DX 150 CAP	1087A5.21
	HERO B: MOD.CIECO 1120 CAP	1087A6.21
	HERO B: MOD.CIECO 1400 CAP	1087A7.21
	HERO B: MOD.CIECO 1680 CAP	1087A8.21
	HERO B: COPPIA TESTATE CAP	1087B1.21

MOUNTING ACCESSORIES

	HERO B: KIT COPPIA CAVI SOSP. 5 M	1087B2.99
	KIT ALIMENTAZIONE L1200 3P BIA	108919.01
	KIT ALIMENTAZIONE L1200 3P CAP	108919.21
	KIT ALIMENTAZIONE L3000 3P BIA	108920.01



Novalux S.r.l. via Marzabotto, 2 40050 Funo di Argelato (BO) Italy
Tel: +39 051 860558 · Fax +39 051 6647859 · Mail: info@novalux.it · VAT number 00536541204 · novalux.com
Company subject to the management and coordination by SLV GmbH

This technical data sheet is owned by Novalux S.r.l., all rights reserved. Novalux S.r.l. reserves the right to make changes without prior notice.
Last update: 14/11/2024, 18:44:53

HERO B

108732.21

novalux
ITALIAN LIGHTING DESIGN SINCE 1948



KIT ALIMENTAZIONE L3000 3P CAP

108920.21



Novalux S.r.l. via Marzabotto, 2 40050 Funo di Argelato (BO) Italy
Tel: +39 051 860558 · Fax +39 051 6647859 · Mail: info@novalux.it · VAT number 00536541204 · novalux.com
Company subject to the management and coordination by SLV GmbH

This technical data sheet is owned by Novalux S.r.l., all rights reserved. Novalux S.r.l. reserves the right to make changes without prior notice.
Last update: 14/11/2024, 18:44:53