

# ALL-TRACK

106727.01

**novalux**  
ITALIAN LIGHTING DESIGN SINCE 1948



## Features

Use: Indoor  
Type of installation: RECESSED  
Colour: WHITE  
Dimming: ON/OFF, 1-10V, 0-10V, DALI  
Emergency: NO  
L: 3000mm  
A: 56mm  
H: 36mm  
Warranty: 5 years  
Weight: 3.98kg

## Tech data

IP: 20  
Insulation class: I

## Compliance

CEI EN 60570/A2:2020



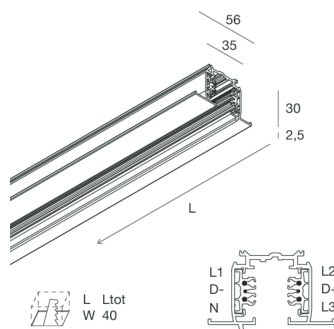







[View more product info](#)



Novalux S.r.l. via Marzabotto, 2 40050 Funo di Argelato (BO) Italy  
Tel: +39 051 860558 · Fax +39 051 6647859 · Mail: info@novalux.it · VAT number 00536541204 · novalux.com  
Company subject to the management and coordination by SLV GmbH

This technical data sheet is owned by Novalux S.r.l., all rights reserved. Novalux S.r.l. reserves the right to make changes without prior notice.  
Last update: 14/11/2024, 18:24:34

## COMPLETION ACCESSORIES

	ALL-TRACK: GIUNTO ELETTRIFICATO BIANCO	106707.01
	ALL-TRACK: COVER CONNETT.LIVE-END BIA	106729.01
	ALL-TRACK: COVER CONNETTORE MIDDLE BIA	106730.01
	ALL-TRACK: COVER CONNETTORE "L" BIA	106731.01
	ALL-TRACK: COVER CONNETTORE "T" BIA	106732.01
	ALL-TRACK: COVER CONNETTORE "X" BIA	106733.01
	ALL-TRACK: TESTATA INC. CHIUSURA BIANCA	106734.01
	ALL-TRACK: ALIM. CENTRALE/GIUNTO BIANCO	106704.01
	ALL-TRACK: ALIM. DI TESTA DX BIANCA	106705.01
	ALL-TRACK: ALIM. DI TESTA SX BIANCA	106706.01
	ALL-TRACK: GIUNTO ELETTRIFICATO NERO	106707.02
	ALL-TRACK: TESTATA CHIUSURA BIANCA	106708.01

# ALL-TRACK

106727.01

**novalux**  
ITALIAN LIGHTING DESIGN SINCE 1948



Novalux S.r.l. via Marzabotto, 2 40050 Funo di Argelato (BO) Italy  
Tel: +39 051 860558 · Fax +39 051 6647859 · Mail: [info@novalux.it](mailto:info@novalux.it) · VAT number 00536541204 · [novalux.com](http://novalux.com)  
Company subject to the management and coordination by SLV GmbH

This technical data sheet is owned by Novalux S.r.l., all rights reserved. Novalux S.r.l. reserves the right to make changes without prior notice.  
Last update: 14/11/2024, 18:24:34



ALL-TRACK: GIUNTO A X BIANCO

106709.01



ALL-TRACK: GIUNTO A T INTERNO SX BIANCO

106710.01



ALL-TRACK: GIUNTO A T INTERNO DX BIANCO

106711.01



ALL-TRACK: GIUNTO A T ESTERNO SX BIANCO

106712.01



ALL-TRACK: GIUNTO A T ESTERNO DX BIANCO

106713.01



ALL-TRACK: GIUNTO A L INTERNO BIANCO

106714.01



ALL-TRACK: GIUNTO A L ESTERNO BIANCO

106715.01



ALL-TRACK: GIUNTO FLESSIBILE BIA

106716.01



ALL-TRACK: ADATTATORE 3P BIANCO

106718.01



ALL-TRACK: ADATT. 3P+DALI BIANCO

106719.01

## MOUNTING ACCESSORIES



KIT SOSPENSIONE REG. 2 PZ. BIANCO

106721.01

ALL-TRACK: FISS.A PLAFONE X BINARIO BIA

106717.01



# ALL-TRACK

106727.01

novalux

ITALIAN LIGHTING DESIGN SINCE 1948

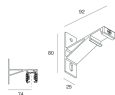

ALL-TRACK: STAFFA A PARETE BIANCA

106724.01



Novalux S.r.l. via Marzabotto, 2 40050 Funo di Argelato (BO) Italy  
Tel: +39 051 860558 · Fax +39 051 6647859 · Mail: info@novalux.it · VAT number 00536541204 · novalux.com  
Company subject to the management and coordination by SLV GmbH

This technical data sheet is owned by Novalux S.r.l., all rights reserved. Novalux S.r.l. reserves the right to make changes without prior notice.  
Last update: 14/11/2024, 18:24:34