

# novalux

ITALIAN LIGHTING DESIGN SINCE 1948

via Marzabotto, 2 - 40050 Funo di Argelato - Bologna - Italy

## HERO MINI

L (mm)

NR. SORGENTI  
NR. LIGHT SOURCES

2700K

3000K

4000K

Figura  
Image

MODULO LED PER DIFFUSORE  
OPALE  
LED MODULE FOR OPAL  
DIFFUSER

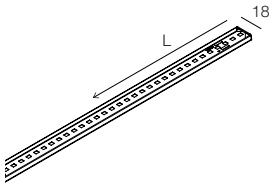

636  
1272  
1908

2  
4  
6



NOVALUX srl  
442700133

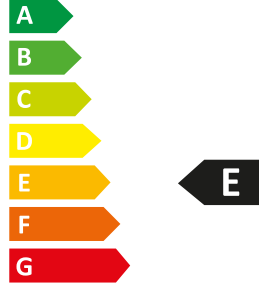

6  
kWh/1000h



2019/2015



NOVALUX srl  
442700134

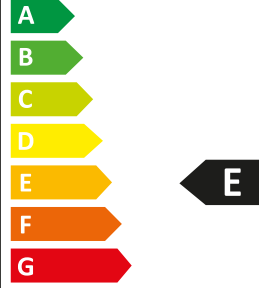

6  
kWh/1000h



2019/2015



NOVALUX srl  
442700135

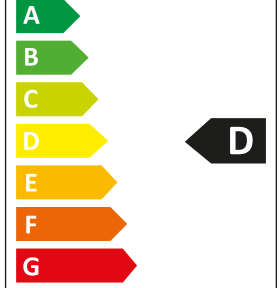

6  
kWh/1000h



2019/2015

1

L (mm)

NR. SORGENTI  
NR. LIGHT SOURCES

2700K

3000K

4000K

Figura  
Image

MODULO LED MICRO OTTICHE  
MICRO-OPTICS LED MODULE

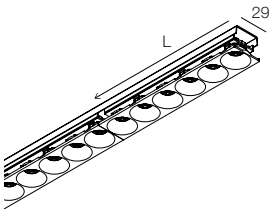

636

2



NOVALUX srl  
442700136

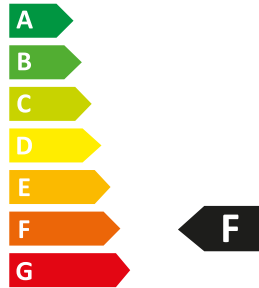

9  
kWh/1000h



2019/2015



NOVALUX srl  
442700137

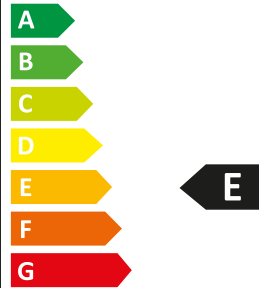

9  
kWh/1000h



2019/2015



NOVALUX srl  
442700138

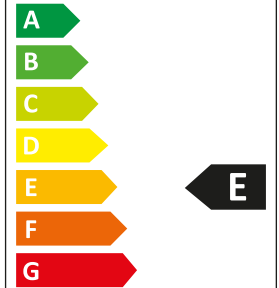

9  
kWh/1000h



2019/2015

2

L (mm)

NR. SORGENTI  
NR. LIGHT SOURCES

2700K

3000K

4000K

Figura  
Image

MODULO SPOT LED  
LED SPOT MODULE

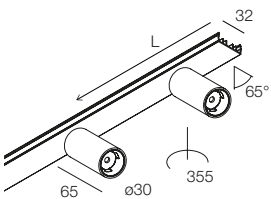

636

2



NOVALUX srl  
442700176

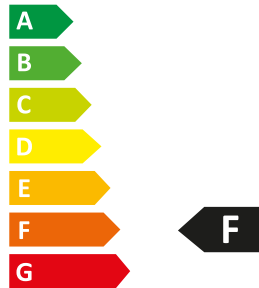

3  
kWh/1000h



2019/2015



NOVALUX srl  
442700177

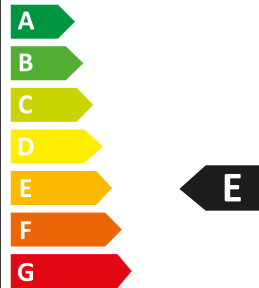

3  
kWh/1000h



2019/2015



NOVALUX srl  
442700178

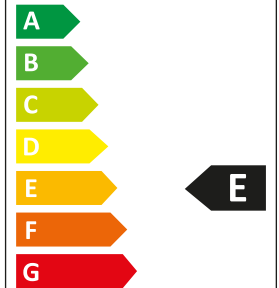

3  
kWh/1000h



2019/2015

3

Figura  
Image  
**1**

**LIGHT SOURCE**



Figura  
Image  
**2**

**LIGHT SOURCE**

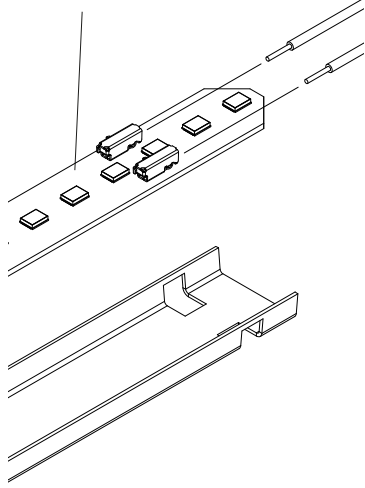

Figura  
Image  
**3**

**LIGHT SOURCE**

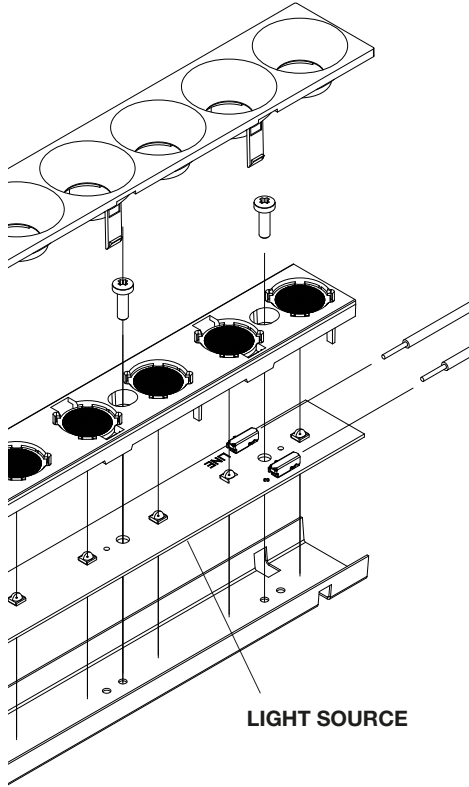
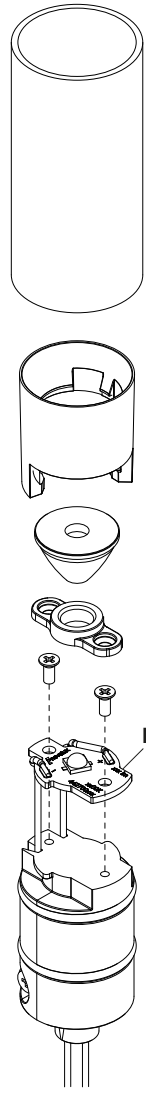

# novalux

ITALIAN LIGHTING DESIGN SINCE 1948

via Marzabotto, 2 - 40050 Funo di Argelato - Bologna - Italy

## HERO MINI B

L (mm)

NR. SORGENTI  
NR. LIGHT SOURCES

2700K

3000K

4000K

Figura  
Image

MODULO LED PER DIFFUSORE  
OPALE  
LED MODULE FOR OPAL  
DIFFUSER

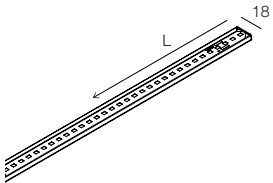

636  
1272  
1908

2  
4  
6



NOVALUX srl  
442700133

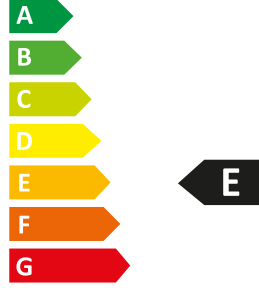

6  
kWh/1000h



2019/2015



NOVALUX srl  
442700134

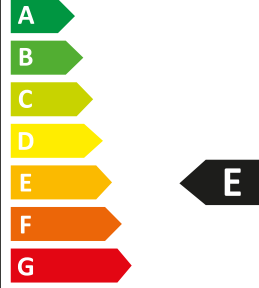

6  
kWh/1000h



2019/2015



NOVALUX srl  
442700135

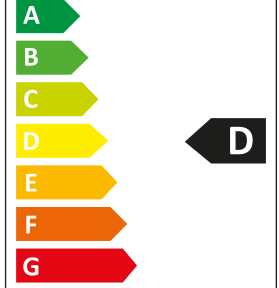

6  
kWh/1000h



2019/2015

1

L (mm)

NR. SORGENTI  
NR. LIGHT SOURCES

2700K

3000K

4000K

Figura  
Image

MODULO LED MICRO OTTICHE  
MICRO-OPTICS LED MODULE

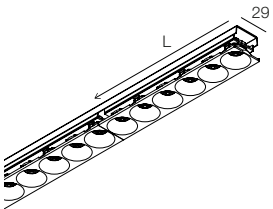

636

2



NOVALUX srl  
442700136

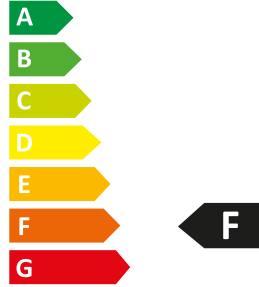

9  
kWh/1000h



2019/2015



NOVALUX srl  
442700137

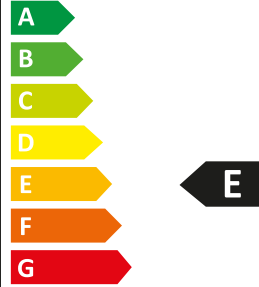

9  
kWh/1000h



2019/2015



NOVALUX srl  
442700138

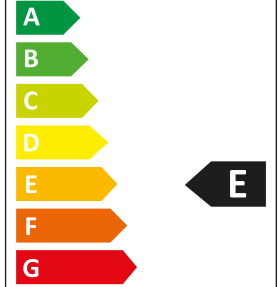

9  
kWh/1000h



2019/2015

2

L (mm)

NR. SORGENTI  
NR. LIGHT SOURCES

2700K

3000K

4000K

Figura  
Image

MODULO SPOT LED  
LED SPOT MODULE

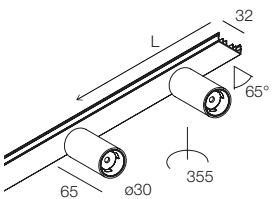

636

2



NOVALUX srl  
442700176

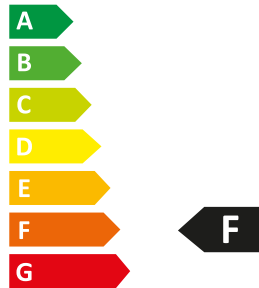

3  
kWh/1000h



2019/2015



NOVALUX srl  
442700177

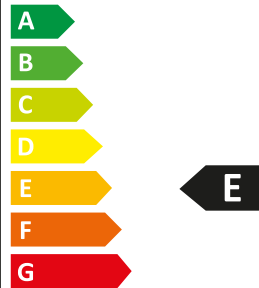

3  
kWh/1000h



2019/2015



NOVALUX srl  
442700178

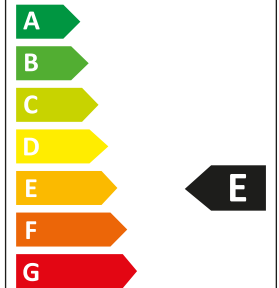

3  
kWh/1000h



2019/2015

3

MODULO LED EMISSIONE  
INDIRETTA  
LED MODULE INDIRECT  
EMISSION

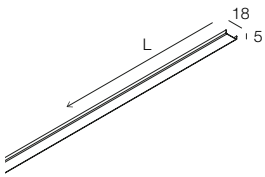

636  
1272  
1908

1  
3  
5

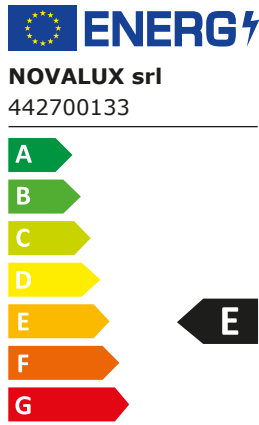

6 kWh/1000h



2019/2015

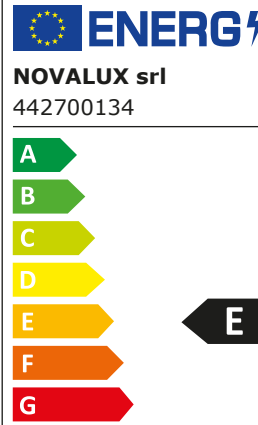

6 kWh/1000h



2019/2015

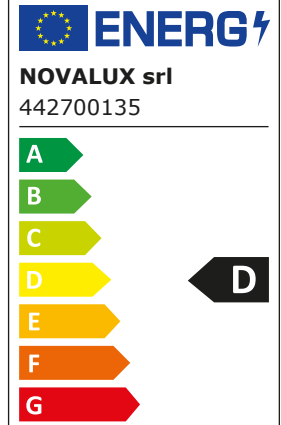

6 kWh/1000h



2019/2015

4

Figura  
Image

1

LIGHT SOURCE



Figura  
Image

2

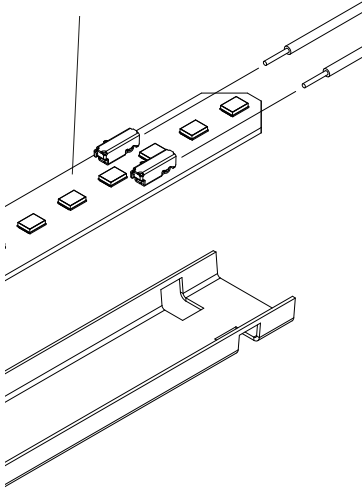
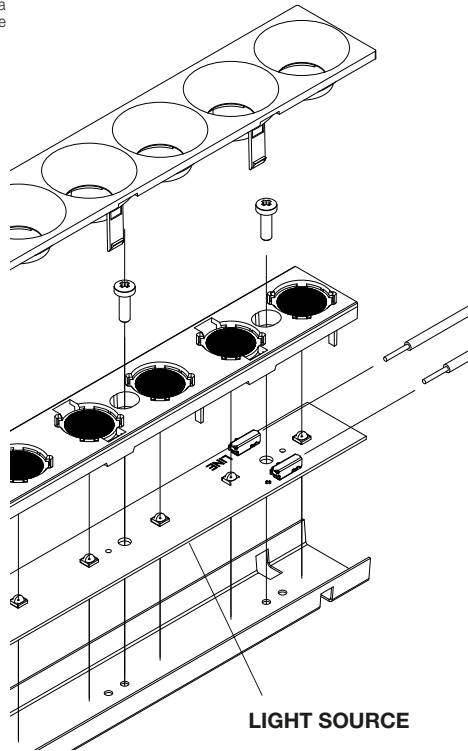

LIGHT SOURCE

Figura  
Image

3

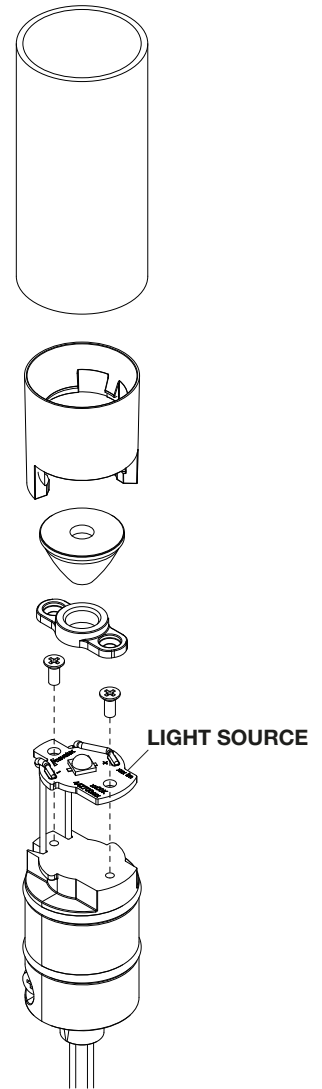

LIGHT SOURCE

Figura  
Image

4

